

STERILIZATION BY IONIZING RADIATION

STERILIZATION
BY
IONIZING RADIATION

ISBN
0-919868-00-2

©Johnson & Johnson Limited (1974)
2155 Pie IX Blvd.
Montréal, Québec H1V 2E4, Canada

TECHNICAL DEVELOPMENTS AND PROSPECTS OF STERILIZATION BY IONIZING RADIATION

**INTERNATIONAL CONFERENCE, VIENNA, AUSTRIA
April 1 - 4, 1974**

SPONSORED BY

Johnson & Johnson

Editors: E. R. L. Gaughran and A. J. Goudie

**MULTISCIENCE PUBLICATION LIMITED
MONTRÉAL, QUÉBEC, CANADA**

Acknowledgement

Johnson & Johnson wishes to express its sincere appreciation to the United Kingdom Panel on Gamma and Electron Irradiation and to all others who assisted in planning the program and suggesting participants.

PREFACE

Interest in the application of ionizing radiation in the sterilization of biomedical products, biological tissues and medical devices has increased tremendously during the last decade, as evidenced by the abundant literature. Most of the work has focused upon the use of isotope sources, particularly cobalt, while the use of electron sources has received little attention. Although the use of electron sources has experienced a decline in the last decade, significant technical advances have been made in the equipment used to generate the electron beam. One of the important goals of the Conference was to bring together this new information on the electron beam machines, at the same time bring up-to-date our knowledge of cobalt and cesium sources.

A second goal of the Conference was to present the newer concepts for measuring the dose of radiation delivered to the material being sterilized. The information on the sources of radiation and dosimetry are applicable in the sterilization of many materials: drugs, tissues and devices. In the session on the effects on the materials being subjected to ionizing radiation, emphasis has been placed on basic radiation chemistry and on the materials of which medical devices are constituted or packaged. That the effects on drugs and tissues entered the discussion was inevitable.

Important papers in the Conference covered dose rate effects and, of equal importance with the technology, the future prospects of radiation sterilization as viewed by the experts in attendance.

The United States has lagged behind the rest of the world in the application of ionizing radiation to the sterilization of medical products. Johnson & Johnson, however, through one of its companies, Ethicon, Inc., pioneered both the use of the electron beam and gamma radiation in the sterilization of sutures. Historically, Johnson & Johnson was founded on the premise of promoting Lister's principles of antiseptic surgery in the United States and of providing the medical profession with antiseptic dressings. Later the company played a major role in the transition from antiseptic to aseptic surgery. Soft, pliable dressings of cotton and gauze were introduced. And, in the belief that the dressings should be as ready for surgery as a surgeon himself, they were prepared in aseptic areas by operators garbed in sterile attire and packaged in containers designed for both sterilization and maintenance of sterility to the ends of the earth. Sterilization was carried out in America's, if not the world's, first two-door commercial steam autoclave, which handled large wheeled carts on tracks and operated on steam under pressure at 240°F. This was 1890, just three years after von Bergmann sterilized some surgical dressings

in a small Wiesnegg laboratory digester, which we now know as an autoclave.

During the period of transition from antiseptis to asepsis, Johnson & Johnson expounded this philosophy intramurally and outside the company anonymously through privately printed publications. The classic paper presenting this philosophy and understanding in the manufacture of surgical dressings was presented by Dr. Frederick B. Kilmer, Johnson & Johnson's first Research Director and father of Joyce Kilmer, in the January 1897 number of the American Journal of Pharmacy. The understanding of environmental control, sterilization and biological indicators are so advanced beyond their time, that they may well be read to advantage today.

So too, Johnson & Johnson has pioneered in the development of ethylene oxide sterilization and, as noted earlier, radiation sterilization. The publication of the proceedings of the present Conference is considered part of our responsibility in sharing this wealth of information with both the rest of the industry and the medical profession. The editors have found it difficult to select this small group of notable contributors from the many excellent scientists throughout the world. It is regrettable that the contingencies of time and space would not allow the inclusion of microbiological and regulatory considerations. We hope that these topics may be discussed at future conferences.

New Brunswick

New Jersey

E. R. L. Gaughran

A. J. Goudie

CONTENTS

Copyright

Preface

INTRODUCTORY SESSION

Opening Remarks. *R. A. Fuller*

Welcome by President of Conference. *J. C. Kelsey*

Application of Ionizing Radiation to Sterilization. *L. B. Sztanyik*

FIRST SESSION

Introduction to Ionizing Radiation Equipment. *N. W. Holm*

ELIT Type Pulse Electron Accelerators Based on a Tesla Transformer. *S. B. Vasserman*

Developments in Transformer Accelerators and the Technology of Pulsed Electron Sterilization at Ultra-High Dose Rates. *S. V. Nablo*

Advances in Electron Beam Linear Accelerator Technology. *J. Haimson*

High-Voltage Electron Accelerators with Local Biological Shield. *A. S. Ivanov*

DC Accelerators. *W. J. Ramler*

Commercial Units for Radiation Sterilizing Medical Products. *V. B. Osipov, S. V. Mamiconyan, G. D. Stepanov, Yu. S. Gorbounov, A. A. Koudryavtsev, B. M. Terentyev, I. I. Sarapkin, Yu. I. Saphonov, N. G. Concov, B. M. Vanyushkin, S. Yu. Crylov, E. S. Corzhenevsky, V. M. Levin, V. A. Gloukhikh, B. I. Mountyan*

Cobalt-60 Irradiator Designs. *A. Brynjolfsson*

The Prospects of Using Cesium for Radiosterilization. *R. Eymery*

Panel — Questions and Answers

General Discussion

SECOND SESSION

Introduction to the Dosimetry Session — Dosimetry in the Megarad Range. *S. C. Ellis*

Solid-Phase Chemical Dosimetry. *W. L. McLaughlin*

Liquid Chemical Dosimeters. *I. Draganič*

Problems of Dosimetry at High Dose Rate. *B. D. Michael*

Dosimetry Techniques for Commissioning a Process. *K. H. Chadwick*

Some Dose Rate Considerations in Radiation Chemistry and Radiobiology. *G. E. Adams and P.*

Wardman

Single user license provided by AAMI. Further copying, networking, and distribution prohibited.

Panel — Questions and Answers

General Discussion

THIRD SESSION

Aspects of the Radiation Chemistry of Small Organic Molecules. *D. Schulte-Frohlinde*

Physical and Chemical Effects of Ionizing Radiations on Polymeric Systems. *A. Chapiro*

Physical and Chemical Effects of Ionizing Radiation on Plastic Films, Laminates and Packaging Materials. *D. W. Plester*

Physical and Chemical Effects of Ionizing Irradiation on Cellulosic Material. *W. C. Bradbury*

Panel — Questions and Answers

General Discussion

FOURTH SESSION

Present Status and Future Prospects for Radiation Sterilization. *R. S. M. Frohnsdorff*

General Discussion

Participants

INTRODUCTORY SESSION

Conference President

J. C. Kelsey

Opening Remarks

by R. A. Fuller

I am very happy, on behalf of Johnson & Johnson and its worldwide family of companies, to welcome you to Vienna and to this Conference on the technical developments and prospects for sterilization by ionizing radiation.

Our company, which had its beginning in the production of so called "surgically clean" dressings, following the teachings of Lister, has been a pioneer in the provision of sterile dressings and devices for health care, and in the use of ionizing radiation for this purpose. We presently use radiation to sterilize products in ten countries and these products are then provided to many other countries as well. Our newest facility, which began operation only last week in the United States, will be used to sterilize products which, only a relatively few years ago, were considered to be incapable of undergoing irradiation because of destruction of the materials from which they are constructed. The progress that has been made in removing the barriers to radiation sterilization is exciting. As a result of this and our increasing needs we share your intense interest in this field and are, therefore, pleased to be able to sponsor this Conference.

It is my sincere hope that you will enjoy your stay in Vienna and that you will find the meeting stimulating, not only from the point of view of the formal presentations and discussions, but for the opportunity it affords for informal discussion and exchange of ideas with your scientific colleagues from around the world. We are delighted that so many of the recognized leaders in this field are present and that among the approximately 130 participants, we have representation from 27 different countries. This is graphic testimony to the growing worldwide interest in, and importance of, sterilization by ionizing radiation.

It is now my pleasure to introduce to you Dr. J. C. Kelsey, whom we are privileged to have as President of your Conference. Dr. Kelsey was born in England and educated at Clare College, Cambridge and the London Hospital where he qualified in medicine in 1951 and specialized in microbiology. He is a fellow of the Royal Society of Pathologists and it was through his practice of pathology that he first became interested in the field of sterilization. As a result of a post mortem which he conducted many years ago, it was determined that a pregnant woman had died as a result of a tetanus infection caused by the use of a non-sterile needle to aspirate her chest. This needless and tragic occurrence directed his interests to the problems of sterilization and disinfection. Another interest of his has been the provision of adequate laboratories in developing countries sparked by his experiences as a young man in India.

Dr. Kelsey has published extensively, and been a member of numerous local, national, and international committees. He was a member of the United Kingdom Panel and a consultant for the World Health Organisation. After a period of teaching, and various academic and hospital appointments, he became the deputy director of the Public Health Laboratory Service for England and

Wales, a post he presently holds. Although he modestly says that he is out of his field as a microbiologist, in a conference directed toward the more physical aspects of sterilization, (and therefore he has asked me to request that no questions on physics be asked of him), I know that you will find him to be a most capable President of our Conference.

It is an honor to introduce Dr. Kelsey.

Welcome by President of Conference

J.C. Kelsey

This Conference is like a ship, ready to set out on a voyage. The first thing that is seen is the figurehead, which is designed to look beautiful and to bring good luck. I am the figurehead on this occasion. I am not beautiful, but at least, I hope to bring good luck.

Behind every ship setting out on a voyage, there are more important figures than the figurehead. These are the owners who decide to build and equip the ship for its voyage. This Conference was conceived by Johnson & Johnson and we are grateful to all their staff for making it possible.

A ship needs on the bridge, skilled officers of the watch to guide it safely on its course. We are lucky to have a group of skilled chairmen and moderators who will guide our proceedings.

No ship can sail without a crew, alert, attentive to its duty, experienced and well fed. We are a multinational crew, clearly alert, and attentive as can be seen from my position at the rostrum. I know us to be experienced and, if last night's reception can be taken as a guide, we will be well fed and thus contented.

The traditional figurehead is necessarily dumb, but modern technology has warned me to do double duty as a public address system and I will now proceed to give out the practical notices about the conduct of this Conference. (Notices given).

Our ship is now ready to set out on its voyage across the oceans of talk. We will need to beware of rocks; intractable problems that may appear on our course; of storms of disagreement; of monsters that may threaten us, such as global shortage of plastics; of seductive sirens, like those who attempted to beguile Ulysses away from his set course into unprofitable channels.

However, we have our ship, well built and equipped, with skilled officers and an experienced crew. Indeed we have a figurehead as well. I am confident that we will reach our harbour and be able to unload our precious cargo of medical devices, well suited for their purpose, of a high probability of sterility and at a cost that the user can afford. Let us now set sail, with our course, set by our pilot, Dr. Sztanyik of the IAEA.

Application of Ionizing Radiation to Sterilization

L. B. Sztanyik

Division of Life Sciences, International Atomic Energy Agency, Vienna, Austria

Ionizing radiation has been employed for sterilization of medical equipment and supplies for more than 15 years. Since the early 1960's, this technology has grown rather fast and steadily to the point where there are now approximately 50 commercial or semi-commercial gamma-sterilization plants and numerous other plants using accelerated electrons for sterilization of medical products all over the world.

Radiation offers several advantages as a sterilization method that makes it attractive in a growing number of situations. The assortment of the major articles sterilized by radiation to date includes a large variety of disposable medical products, sutures and implants, pharmaceuticals and cosmetics, biological tissues and preparations of biological origin, and many other articles.

Among the factors affecting progress in this regard, the results of radiation chemistry and radiation microbiology research, system of public health and medical care of population, developments in chemical industry, advances in radiation technology, economy aspects, environmental considerations, legislation and regulatory requirements are mentioned and to some extent analysed in the paper. The activity of the International Atomic Energy Agency executed in this field during the past 10 years is also outlined and its contribution to the developments evaluated.

Introduction

It is one of the statutory tasks of the International Atomic Energy Agency (IAEA) “to accelerate and enlarge the contribution of atomic energy to peace, health and prosperity throughout the world”.

In keeping with these objectives the Agency's radiation biology program has been designed to promote the practical applications of known radiobiological effects in the fields of medicine, public health, agriculture and food production, and in certain areas of industry¹.

The microbicidal activity of ionizing radiation is one of the radiobiological effects that is of considerable interest in medicine and public health. It has already been employed for sterilizing medical equipment and supplies, medicaments and pharmaceutical starting materials, cosmetics, biological tissues and other bio-preparations.

For more than 10 years, the IAEA has actively contributed to the development of this new technology by (a) supporting research, (b) organizing scientific meetings and training courses, (c) providing technical assistance to developing Member States in the form of expert services and fellowships, (d) issuing scientific publications (including a manual and several panel and symposium proceedings), and (e) in particular, assisting with the preparation of an international “Code of Practice”. The Agency publications in this field are frequently referred to by speakers of meetings and authors of articles on radiation sterilization. My present paper is also essentially compiled from these Agency publications (see Table I).

Table I. — Scientific meetings organized by the IAEA with regard to radiation sterilization

*Application of Large Radiation Sources in Industry and Especially to Chemical Processes [C]	8-12 September, 1959 Warsaw	1960
*Application of Large Radiation Sources in Industry [C]	27-31 May, 1963 Salzburg	1963
Radiosterilization of Medical Products, Pharmaceuticals and Bioproducts [P]	17-19 January, 1966 Vienna	1967
Code of Practice for the Radiosterilization of Medical Products [P]	5-9 December, 1966 Vienna	1967
Radiosterilization of Medical Products [S]	5-9 June, 1967 Budapest	1967
Radiation Sterilization of Biological Tissues for Transplantation [P]	16-20 June, 1969 Budapest	1970
*Utilization of Large Radiation Sources and Accelerators in Industrial Processing [S]	18-22 August, 1969 Munich	1969
Revision of the IAEA Recommended Code of Practice for the Radiation Sterilization of Medical Products [W]	5-9 June, 1972 Risö	1974
Radiation Sterilization of Medical Products, Pharmaceuticals and Biological Tissues [R]	22-23 November, 1971 Risö	—
Radiation Sterilization of Medical Products, Pharmaceuticals and Biological Tissues [R]	14-16 February, 1973 Budapest	—

Notes: [C] = Conference; [P] = Panel meeting; [R] = Research co-ordination meeting; [S] = Symposium; [W] = Working group meeting.

*Meetings partly related to radiation sterilization.

Advantages of the radiation sterilization technique

In a broad sense of the term, *sterilization* is defined as complete destruction or removal of all forms of contaminating microorganisms from the material or product processed. Accordingly, radiation sterilization involves the application of sufficient ionizing energy in the forms of X-rays, gamma-rays or electron beams, to render an article free of viable micro-organisms^{2,3}.

The capability of ionizing radiation to kill bacteria was widely known in the early 1920's. However, it was only after the Second World War, when large radiation sources became available, that work was initiated on the application of ionizing radiation to sterilization of foodstuffs, and pharmaceutical and medical products. While the problems of eliminating all microbial activity in food products proved too difficult and complicated to be solved, and verification of the wholesomeness of irradiated food necessitated an almost endless series of experiments, the large-scale introduction of radiation for sterilization of medical products held out promises of earlier and easier success from the very beginning⁴. Over the past two decades, radiation sterilization of medical products has increased rapidly and become one of the most successful large-scale applications of atomic energy for peaceful purposes, being second only to power generation⁵.

Radiation, as a sterilizing agent, offers a number of advantages that make it an attractive choice in a number of situations⁶⁻⁸.

(1) Radiation is a suitable means of sterilizing many materials, except for certain plastics, glass and, of course, living cells. At the sterilizing dose usually applied, radiation causes no significant temperature rise, which permits sterilization of heat-sensitive drugs and articles made of low melting-point plastics. It is certainly the best, and often the only method of sterilizing biological tissues and preparations of biological origin.

(2) Due to its high penetrating ability, gamma-radiation reaches all parts of the object to be sterilized. The items can be pre-packed in hermetically sealed, durable packages, impermeable to microorganisms. The shelf-life of these pre-packed and radiation sterilized items is practically indefinite. The convenience of packing and boxing prior to sterilization eliminates the need for aseptic areas and procedures. It also adds an intangible psychological asset to the product in that it is not touched after the sterilization procedure.

(3) The chemical reactivity of radiation is relatively low compared with the often highly reactive gases. Hence, the possibility of inducing a chemical reaction that may lead to disadvantageous changes in the products is minimal. For the same reason, radiation offers a greater freedom than heat or gas sterilization in the selection of suitable packaging materials. Many thermoplastics can be used and the permeability factors associated with the steam and gas processes are not relevant either. Although some plastic materials can be affected by radiation (polypropylene, PVC, etc), radioresistant grades of these polymers are already available.

(4) Since there is no problem similar to convection of heat or diffusion of gas, the effect of radiation is instantaneous and simultaneous in the whole of the target. This also permits of stopping the effect of radiation at the desired moment, or adding to any dose already delivered a precisely defined additional dose-value, if necessary, to achieve sterility.

(5) Radiation can be easily adapted for continuous processing, as compared with the batch operation currently in use with gas sterilization. Continuous operation requires, in general, less labour, but also presupposes large-scale production to be practical and economical.

(6) The process is the most reliable of all competing sterilization methods due to the absolute certainty that the radiation source emits radiation of known energy and power. Therefore, time is the only variable that requires monitoring once the process parameters have been established. The normal decay of the radioisotope can be corrected for by adjusting the irradiation time or the conveyor speed. All the other methods of sterilization depend on simultaneous control of many factors, such as temperature, pressure, concentration, humidity, and others (see Table II).

Table II. — Factors to be controlled in a reliable sterilization process⁸

Factor	Autoclaving	Gamma radiation	Ethylene oxide gas
Time	Yes	Yes	Yes
Temperature	Yes	No	Yes
Pressure	Yes	No	Yes
Vacuum	Yes	No	Yes
Concentration (diffusion)	(Yes)	No	Yes
Wrapping	Yes	No	Yes
Humidity	No	No	Yes

Present status in radiation sterilization of medical products

Radiation sterilization plants

Nowadays, radiation sterilization of medical products can be effected either on a small scale, using experimental irradiation facilities, or on a large scale, in various industrial radiation sterilization centres. In both cases, electron accelerators and gamma installations can be applied as radiation sources.

Hundreds of general purpose gamma irradiators for research are currently operating throughout the world. They are used to carry out preparatory studies or pilot-scale projects for industrial sterilization of medical products. Research facilities are also employed to sterilize items that are not mass produced, such as pieces of equipment used in operating theatres, and that cannot be subjected to heat or chemical treatment. In addition, there is a steadily increasing requirement for radiation sterilization of implants, biological tissues for transplantation surgery, and other preparations of biological origin.

For the sterilization of such items, versatile irradiation facilities are needed that permit a wide range of sample sizes and broad spectrum of materials to be treated. This small-scale radiation sterilization is usually accomplished at irradiators of research institutes, universities or hospitals.

Large-scale sterilization is performed in a commercial or semi-commercial production plant operating as a part of the manufacturing system. It usually processes the products of one firm only. There is, of course, the possibility of combining treatment of the house products with contract work for a number of other manufacturers. In the extreme case, multipurpose units are set up entirely for contract work, executing service irradiation for the chemical, food and medical industries⁹⁻¹⁰.

At the present time, there are nearly 50 commercial and semi-commercial gamma radiation sterilization plants all over the world, having a total capacity of 35 to 40 million curies of cobalt-60. The actual load of these gamma irradiators might be about 25 to 35% of the total capacity (Table III).

The number of gamma sterilization plants installed has increased steadily between 1960 and 1974, the yearly average being just over three (3.2), and about 2.3 MCi in capacity (Figure 1). All but one gamma sterilization plants have a cobalt-60 source, the exception is a demonstration facility in France, using caesium-137.

The geographical distribution of these sterilization plants is rather unbalanced. In this respect, Europe is far ahead of the other continents of the world, possessing 62.5% of all sterilization plants. After Europe come North and South America with 16.7%; Asia with 10.4%; Australia and New Zealand with 8.3%; and finally Africa with only 2% (Figure 2).

At the very beginning, radiation sterilization of single-use and pre-packed medical products was introduced only into the industrial practice of technologically developed countries. Recently, however, a growing interest in this technology has been ascertained on the part of developing countries, too. Some of these countries have already installed sterilization plants, while others are planning to do so in the near future. In addition to the 17 developed and 6 developing countries that already have gamma-sterilization plants, an additional four or five developing countries are known to be interested in an early introduction of industrial radiation sterilization technology, among these are the Arab Republic of Egypt, Hungary, South Korea and the Sudan.

Table III. — Commercial and semi-commercial gamma-irradiators for sterilization of medical products

Location	Operator	Designer	Capacity, (MCi) actual maximal		Date of commissioning
<i>ARGENTINA</i>					
Ezeiza nr. Buenos Aires	C.N.E.A.	C.N.E.A.	0.225	1.000	1970
<i>AUSTRALIA</i>					
Dandenong nr. Melbourne	Gamma Sterilization Pty. Ltd.	AERE, Harwell, U.K.	0.800	2.000	1960
Dandenong nr.	Tasman Vaccine Laboratory (Australia)	A.E.C.L.	0.200	1.000	1971

Melbourne	Pty. Ltd.				
Sydney	Johnson & Johnson Pty. Ltd.	A.E.C.L.		1.000	1972
<i>BRAZIL</i>					
São Paulo	Ibras-CBO Industries	A.E.C.L.		0.500	1972
<i>CANADA</i>					
Peterborough, Ontario	Ethicon Sutures Ltd.	A.E.C.L.	0.030	0.125	1964
Mont St. Hilaire, Quebec	Isomedix Ltd.	A.E.C.L.		0.500	1971
Markham, Ontario	Toronto Sterilized Products	A.E.C.L.	0.250	1.000	1973
<i>CZECHOSLOVAKIA</i>					
Brno	State Textile Res. Inst.	A.E.C.L.		1.000	1972
<i>DENMARK</i>					
Roskilde	Nunc A/S	A.E.C.L.		1.000	1969
<i>FRANCE</i>					
Dagneux nr. Lyon	Conservatome C.L.A.A.	Conservatome	0.850	1.000	1960
Dagneux nr. Lyon	Conservatome	Conservatome	0.180	0.300	1968
Saclay	Conservatome I.R.M.A.	Conservatome	0.170	0.500	1965
Dagneux nr. Lyon	Conservatome	Conservatome	0.850	1.500	1973
<i>DR/GERMANY</i>					
Rosendorf nr. Dresden	Zentralinst. für Kernforschung	own design	0.155	0.500	1967 (reconstr.)
<i>FR/GERMANY</i>					
Hamburg	Ethicon G.m.b.H.	H.S. Marsh NE Ltd.	0.060	0.750	1966
Melsungen	B. Braun Co.	Sulzer Brothers Ltd.		0.600	1966
Rommelshausen	Firma Willy Rüsçh	A.E.C.L.	0.225	1.500	1968
<i>GREECE</i>					
Inofyta nr. Athens	Lefkippos S.A.	A.E.C.L.	0.065	0.500	1973
<i>INDIA</i>					
Trombay nr. Bombay	Isomed	H.S. Marsh NE Ltd.	0.100	1.000	1974
<i>ISRAEL</i>					
Yavne nr. Rehovot	Sor-Van Irradiation Ltd.	A.E.C.L.	0.035	1.000	1972
<i>ITALY</i>					
Bologna	ICO S.p.A.	H.S. Marsh NE Ltd.		0.500	1967
Rome	Ethicon S.p.A.	A.E.C.L.	0.100	0.100	1968
Minerbio	Gammarad Italia	H.S. Marsh NE Ltd.		1.000	1971
<i>JAPAN</i>					
Tochigi	Japan RI Irrad. Service Corp.	?	0.224		1970
Takasaki	Irrad. Development Assoc.	J.A.E.R.I.	0.500		1971
Takasaki	RADIE Industries Co. Ltd.	J.A.E.R.I.	0.200	0.600	1973
<i>NETHERLANDS</i>					

Ede nr. Utrecht	Gammaster Coop. Apoth. Ver.	A.E.C.L.	0.240	1.000	1970
<i>NEW ZEALAND</i>					
Upper Hutt	Tasman Vaccine Laborat. Ltd.	A.E.C.L.	0.215	1.000	1966
<i>NORWAY</i>					
Kjeller nr. Oslo	Institutt for Atomenergi	own design	0.030	0.120	1970
<i>SOUTH AFRICA</i>					
Pelindaba	South African AE Board	A.E.C.L.	0.050	1.000	1971
<i>SPAIN</i>					
Barcelona	Laboratorio Aragón	JEN, Madrid	0.025	0.330	1971
<i>SWEDEN</i>					
Skärhamn nr. Göteborg	Radona Irradiation AB	H.M.Marsh NE Ltd.	0.215	1.000	1968
Rotebro nr. Stockholm	Johnson & Johnson AB	A.E.C.L.		1.000	1971
<i>SWITZERLAND</i>					
Neuhausen	SSC Steril-Catgut Ges.	Sulzer Brothers Ltd.		0.050	1972
<i>UNITED KINGDOM</i>					
Wantage (PIP I)	Irradiated Products Ltd.	Rubery Owen Ltd.		0.700	1960*
Slough	Johnson's Ethical Plastics	H. S. Marsh NE Ltd.		0.750	1962
Edinburgh	Ethicon Ltd.	Nuclear Chemical Plant Ltd.		0.250	1963
Reading	Gillette Industries Ltd.	H. S. Marsh NE Ltd.	0.650	0.750	1964
Wantage (PIP II)	Irradiated Products Ltd.	UKAEA		0.700	1965**
Sheffield	Swann-Morton Ltd.	Vickers Ltd.		0.075	1966
Reading	Gamma Radiation Services Ltd.	H.S. Marsh NE Ltd.		1.000	1970
Shoreham	Eschmann Bros & Walsh Ltd.	Vickers Ltd.		0.200	1971
Swindon	Irradiated Products Ltd.	IPL		1.000	1971
Swindon	Irradiated Products Ltd.	IPL		1.000	1973
<i>UNITED STATES OF AMERICA</i>					
Somerville, N.J.	Ethicon Inc.	A.E.C.L.		2.250	1964
San Angelo, Tex.	Ethicon Inc.	A.E.C.L.		2.250	1964
North Canaan, Conn.	Becton, Dickinson & Co.	A.E.C.L.		1.000	1970
Sherman, Tex.	Johnson & Johnson	A.E.C.L.		3.000	1974
Morton Grove, Ill.	Isomedix Inc.	A.E.C.L.		0.500	1974
<i>U.S.S.R.</i>					
Leningrad	Min. Med. Prom.	VNIIRT	0.600 — 0.800		1974 (constr.)

*closed down since 1971

**closed down since 1972

Table IV. — Accelerator plants for radiosterilization of medical products in Europe

Location	Operator	Type of accelerator	Maximum energy of electrons	Power output	Date of commissioning
<i>DENMARK</i>					
Risø	Research Establishment DAEC	LINAC (Varian Ass.)	10 MeV	5 kW	1960
Glostrup nr. Copenhagen	Radest A/S	LINAC (Varian Ass.)	10 MeV	10-15 kW	1967

FRANCE

Corbeville nr. Saclay SRTI/CARIC LINAC CIRCE 10 6-10 MeV 7-10 kW 1967

FR/GERMANY

Köln Leybold's Hochvakuum Anlagen Van de Graaff 3 MeV 6 kW 1957

POLAND

Warsaw Inst. Nucl. Res. AEC LUE 13-9 13 MeV 9-13 kW 1972

UNITED KINGDOM

Birmingham Smith & Nephew Plastics Ltd. Van de Graaff 4 MeV ? 1963

U.S.S.R.

Kurgan Min. Med. Prom. LUE 8-5B 8-10 MeV 5 kW 1974

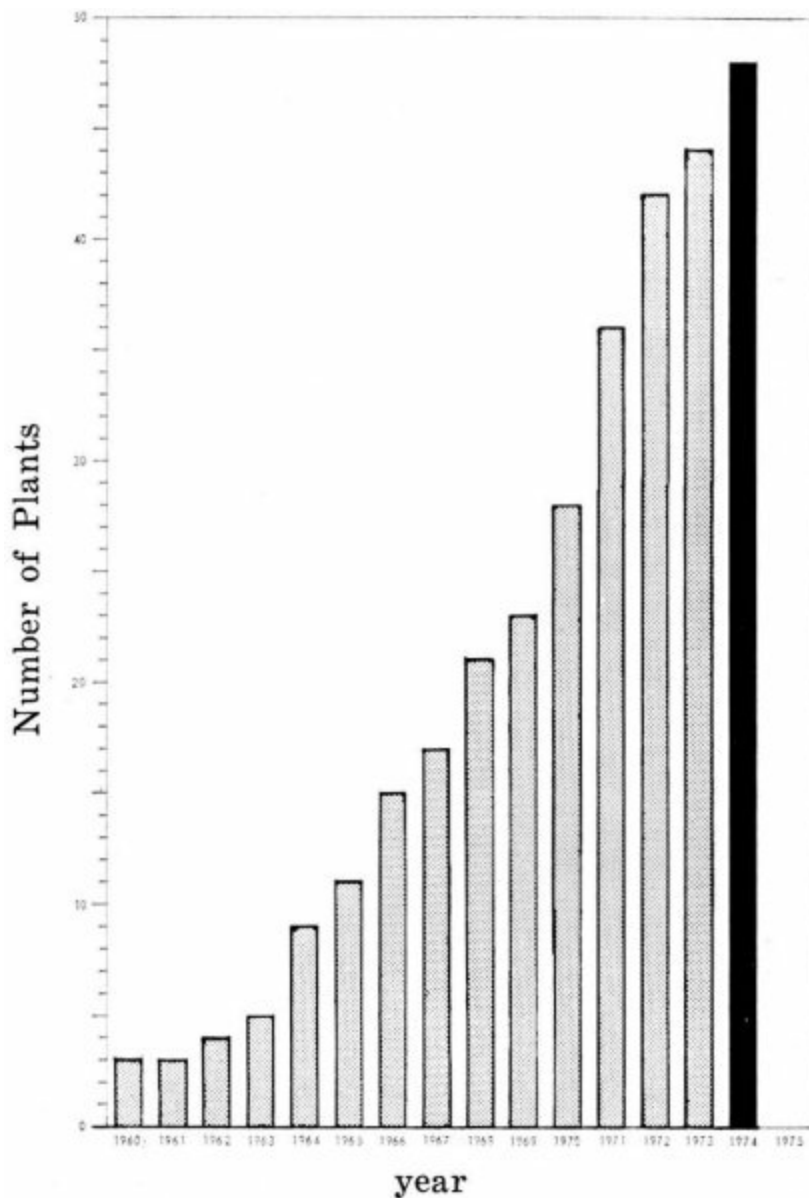

Figure 1. Increase in the number of commercial and semi-commercial gamma sterilization plants in the period of 1960 to 1974.

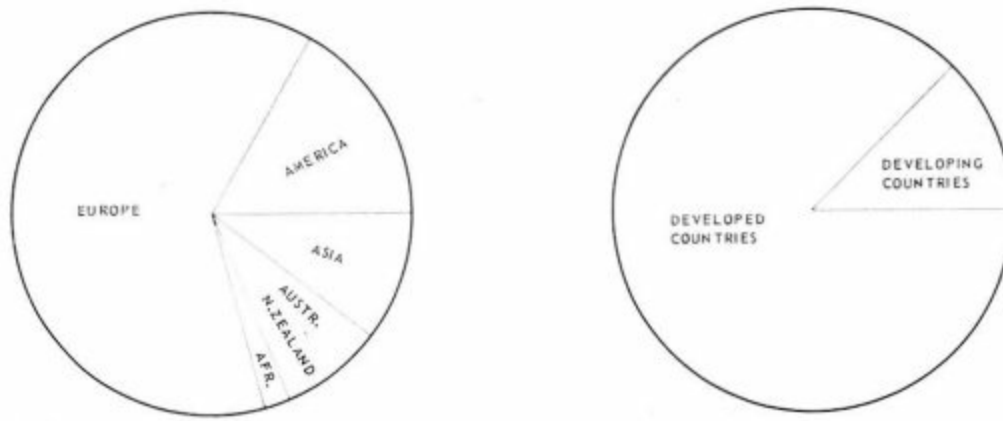

Figure 2. Distribution of industrial gamma sterilization plants among the five continents (left graph), and between developed and developing countries (right graph).

Sterilization plants operating electron accelerators are much less numerous than those having isotope sources. Two types of accelerators can be used for sterilization: electrostatic machines, of which the best known is the Van de Graaff, and linear accelerators.

In Europe, seven such plants are known, of which five operate linear accelerators producing a maximum energy of electrons between 6 and 13 MeV, and power outputs of 5 to 15 kW. The other two plants operate Van de Graaff machines producing electrons of 3 to 4 MeV energy and have power outputs of some 6 to 8 kW (Table IV). Accelerator based, service radiation sterilization plants are believed to provide a significant portion of the total radiation sterilization activity in the USA.

Assortment of major articles sterilized by radiation

Over the last two decades, the variety of radiosterilized articles has increased so enormously that it is now impossible to present anything approaching a complete list of these articles. The assortment includes disposable surgical and medical instruments and devices, laboratory equipment, sutures and other temporary and permanent implants, medicaments and pharmaceutical starting materials, food for pathogen-free diets, biological tissues for transplantation and other biological preparations.

a) Disposable medical products

The widespread industrial use of radiation sterilization has been closely correlated with the rapid development of disposable medical products. Development of a modern, large-scale production of these articles would have been unimaginable parallel to an old, handicraft type of sterilization practice. Moreover, the majority of plastics and other materials commonly used in the manufacture of disposable medical items are rather sensitive to the high temperature and moisture involved in sterilization by dry or moist heat, the two generally accepted and most reliable conventional methods of sterilization. The majority of plastics, however, are not significantly affected in either their physical, chemical or mechanical properties on irradiation with doses sufficient for sterilization (see Table V)^{7,11,12}

Table V. — Summary of the plastics commonly used in devices showing their behaviour when exposed to a sterilizing process

Material	Reported medical use	Dry heat	Autoclave	Boiling water	Radiation	Gas	Liquid
VINYLS							
Unplasticized PVC (rigid)	Anaesthetic airways, endotracheal tubes, tracheostomy tubes, M-to-M double airways, mounts and adaptors, containers	—	—	—	+	*	+
Plasticated PVC (flexible)	Tubings, catheters, cannulae, infant feeding tubes, blood giving and taking sets, blood and plasma bags, aprons and other sheeting	—	*	+	+	*	+
OLEFINES							
Polyethylene, low density (LD)	Implants, ossicles, artificial tearducts, tubing, utensils and containers, film, especially bags for containing sterile articles, film laminates	—	—	—	+	+	+
high density (HD)		—	—	+	+	+	+
Poly (methyl pentene)	Uses under development include syringes, connectors, dishes, trays and laboratory ware	+	+	+	+	+	+
Polypropylene	Bowls and containers, syringes, rigid tubing, moulded connectors, heart valves and film	*	+	+	*	+	+
Ethylene/vinyl acetate (EVA)	Tubing, disposable teats, syringe plungers	*	*	*	+	+	+
STYRENE							
Polystyrene	Hypodermic syringes, sponges, Petri dishes, phials	*	*	*	+	+	+
ACRYLICS							
Polymethyl methacrylate	Dentures, teeth, dental fillings and linings, artificial eye-balls, ophthalmic implants, contact lenses, oxygenators, dialysers, facial prostheses, hypodermic syringes	—	—	±	*	+	+
POLYAMIDES							
Nylons (6, 66, 610, 11)	Sutures, gauze filters, intravenous tubing and cannulae, ureteric and angiography catheters, connectors, adaptors, surgeon's nailbrushes, film for packaging (autoclavable film)	*	+	+	+	+	*
FLUOROCARBON POLYMERS							
Polytetrafluoroethylene (PTFE)	Transfusion set chambers and filters, implants, specialized cannulae, woven yarn fabric for aortic valves and arterial grafts, non-stick coatings	+	+	+	—	+	+
Polytrifluorochloroethylene (PTFCE)		+	+	+	+	+	+
Fluorinated ethylene/propylene resins (FEP)		+	+	+	+	+	+
POLYESTERS							
Polyester resins	Glass-fibre reinforced laminates and in non-reinforced form for potting or encapsulation of electrical components	—	—	*	+	+	+
Polyethylene terephthalate	Film and film laminates	—	+	+	+	+	+
Epoxide resins	Electrical insulation such as for cardiac pacemakers	—	*	*	+	+	+
Silicone rubbers	Electrical insulation, tubing, implants, hydrocephalous valves, arterio-venous shunts	+	+	+	+	+	*
ACETALS							
Polycarbonate	Bowls, containers and utensils, oxygenators, babies' feeding bottles, Petri dishes, syringe components	—	*	+	+	+	*
Acetal homopolymers and copolymers	Needles for blood-transfusion sets	—	+	+	—	+	*
THERMOSETTING MATERIALS							
Phenol formaldehyde resins (PF)	Bottle caps, closures, toilet seats (the same)	+	+	+	+	+	*
Urea formaldehyde resins (UF)		—	+	+	+	+	*
Melamine formaldehyde resins (MF)	Tableware	—	+	+	+	+	*

Key: + = suitable, — = unsuitable * = borderline, suitable in some circumstances, not in others.

The list of different disposable articles that have already found acceptance in medical and health services is limited only by the imagination of designers. In a recent publication entitled "Disposable Products for Health and Social Services" some 900 kinds of such products are listed as being available

in the United Kingdom. Some of these articles, says the introduction to the list, could be cleaned and sterilized for further use, and some could be used more than once by a particular patient. Most, however, are obviously of the “single-use” type¹³.

In the United States of America, there are at present more than 400 different single-use items available for the average hospital. Health expenditures for “disposables” have risen from less than US\$ 20 million in 1955 to more than US\$ 300 million in 1971, and have been estimated as reaching almost US\$ 900 million by 1978, representing 10.5% of the total sales of all medical supplies and equipment¹⁴.

An analytical review of sterile item usage at the 600-bed Stanford University Hospital was published recently by Gonda et al. (1973). Their operational definition of a sterile item is an object or group of objects that remains enclosed in a single packaging envelope once it is sterilized. Accordingly, the average monthly number of sterile *items* used by the hospital is less than the total number of sterile pieces consumed¹⁵.

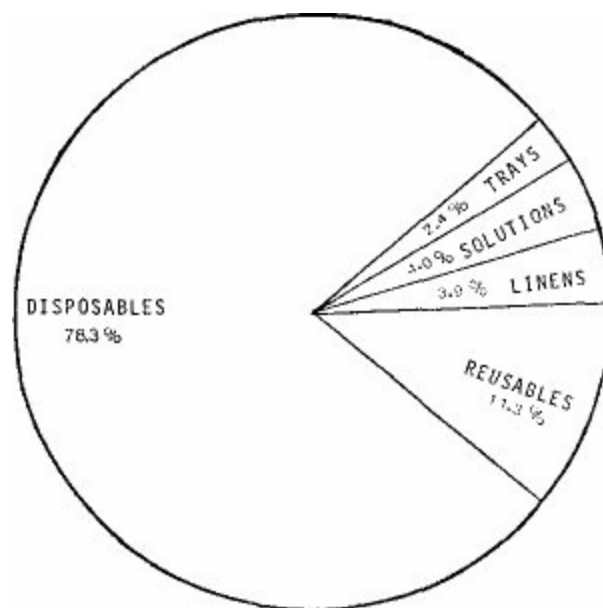

Figure 3. Utilization of different sterile items at the Stanford University Hospital and Medical Center in relationship to the total volume of all sterile item types used.

The following “pie” graph analyses the total population of sterile items by item type: disposables, reusables, linens, solutions, or trays (Figure 3).

Disposables constitute almost 80% of all the sterile items used. It is interesting to note that somewhat more than 80% of the total volume is obtained by the hospital as pre-sterile items, and less than 20% is sterilized in the hospital by means of steam or gas. The major consumer units of these sterile articles are: the nursing units (33.5%) and the operating rooms (27.1%).

The major groups of disposable medical products presently available sterilized by ionizing radiation are listed in the following table (Table VI).

Of all single-use medical products, *hypodermic syringes and needles* constitute the largest volume of items. Within less than 10 years, the use of glass syringes has almost completely disappeared except for operating rooms and special cases. In the United States of America approximately 500 million injections are being given annually with disposable plastic syringes and needles. The world wide figure should amount to about 1500 million¹⁶.

Disposable plastic *gloves*, latex examination gloves and surgical gloves, are probably the second largest product in volume. In the USA alone several hundred millions of these gloves are used annually.

Table VI. — List of disposable medical products successfully sterilized by ionizing radiation commercially or in research programs

	Items used in direct contact with the interior of the patient
I.	<ol style="list-style-type: none">1. <i>Metallic surgical and medical instruments:</i> blood-lancets, clips, needles, preparation razors, scalpels and scalpel-blades, stapes, surgical and dental drills;2. <i>Devices of diagnosis and delivery of medical treatment made of plastics:</i> canullae, catheters, drains, forceps, gloves and finger-stalls, hypodermic syringes and needles, oxygenators, tubes of various types, inhalation therapy equipment, haemodialysis membranes and envelopes, blood collecting sets, infusion and transfusion sets, emergency kits;3. <i>Surgical dressing:</i> absorbent cotton swabs, adhesive tapes, bandages, common and fenestrated surgical drapes, cotton-gauze sponges, eye-pads, paraffin gauze and bandages.
	Items used not in direct contact with the patient's interior
II.	<ol style="list-style-type: none">1. <i>Surgical and patient-care linen:</i> face-masks, hand towels, sanitary pads, surgical gowns;2. <i>Patient-care items made of plastics:</i> aprons, baby-feed bottles, beakers, booties, caps, coats, colostomy and urine bags, diapers, dosing spoons, drapes, eye-droppers, hand brushes, incontinent pads, oxygen masks, patient gowns, recording devices including oral and rectal thermometers, shoe coverings, smocks, splints, towels, trays;3. <i>Laboratory equipment:</i> containers and container closures, culture tubes and media, funnels, laboratory coats and caps, medicine cups, Petri dishes, stirrers, test tubes, etc.

b) *Sutures*

Sutures, made of natural and synthetic polymers, were the first large-volume products to be sterilized by radiation commercially. Radiation sterilization of sutures is superior to heat sterilization in that the sutures can be processed with minimal damage, sterilization is achieved in the final container, more convenient packaging can be used, and the process lends itself for continuous operation. The usual tensile strength of sutures treated with a sterilizing dose of radiation is reduced only by 4-8%. The radiation sterilized catgut is approximately 10% stronger than the heat sterilized material, and causes no more tissue reaction than the heat sterilized product. In addition, the radiation sterilized sutures remain pliable and easier for the surgeon to handle⁴.

According to Artandi (1973), in the USA alone about 15 million surgical operations are performed annually, and in the majority of these radiosterilized absorbable and non-absorbable sutures are used. The total world-wide experience of Johnson & Johnson exceeds one thousand million radiosterilized sutures of all types, which is an impressive figure indeed¹⁷.

c) *Implants*

For materials to be used as permanent or temporary implants, or in contact with circulating blood, technical requirements are more stringent and cost considerations are less important than for common disposable articles. The two most reliable methods of sterilization, which can be used for a wide range of implants, are autoclaving and irradiation, depending on applicability and convenience. For complex devices, where saturation with steam may create problems, radiation is given preference to autoclaving if the material and components of the equipment can withstand irradiation¹⁸.

Of the many plastic materials that are now available, only a few are suitable for permanent implantation, such as medical grades of silicone, PTFE, polyethylene, polypropylene, epoxyresins, methacrylate, and some oxidation-resistant polymers.

The majority of experience with radiation sterilization of plastic implants was obtained with artificial arteries and heart valves. Little change occurs in Teflon™ heart valves when sterilized at 2.5 Mrad and prepacking of the products allowed for keeping an adequate stock for size selection during surgery.

Plastic and irreversible hydrocolloidal materials are commonly used in the following procedures: cranioplasty, tympanoplasty, oculoplasty, contact lens fitting, skin grafting, splinting, fitting cleft palate prostheses and others. There is no evidence in the literature on radiation sterilization of these materials, although they might be appropriate candidates.

For such uses as nails, screws and plates to fix fractures, or joint replacement, certain grades of steel and some cobalt-chromium-molybdenum alloys have been found to be adequate. For replacement of areas in the skull, titanium has been used. For wires inserted in the body and for electrical circuits and electrodes, alloys of platinum with rhodium or iridium have been used. None of these metals are affected by radiation, but they can also be adequately handled by autoclaving¹⁹.

d) *Pharmaceuticals*

Because of its great medical importance and industrial promise, radiation sterilization of pharmaceuticals has been extensively studied. Bacterial contamination of these products constitutes a potential danger not only through inoculating the recipient with infective germs, but also through the ineffective or even toxic by-products resulting from the degradation of the original preparation due to the microorganisms present, albeit not necessarily of a pathogenic species.

The eye-ointments in individual gelatine capsules manufactured by the Upjohn Company in the USA were the first commercially radiosterilized pharmaceutical products. The application of this method to other pharmaceuticals, however, has developed unexpectedly slowly. The principal problem is that the reactive components (mainly free radicals) induced by ionizing radiation in liquid systems, such as injectables and other solutions, can have a profound effect on the essential components of the pharmaceutical preparations; the nature of which is difficult to predict. Indeed, drugs are considerably more stable in the dry solid state than in any other form of molecular aggregation²⁰.

Substantial development in radiation sterilization of medicaments and pharmaceutical starting materials can only be expected from an intense, thorough-going and internationally co-ordinated research effort. This would have, firstly, to clarify such important questions as:

- radiochemical effects of ionizing radiation in sterilizing doses on the active ingredients, adjuvants and excipients of the individual preparations;
- interactions between the radiolysis products themselves and between these products and the components and vehicles of the preparation;
- possible protecting or sensitizing effect of the pharmaceuticals against radiation.

e) *Biological tissues and other biological preparations*

Biological tissues which are notoriously difficult to sterilize by conventional techniques provide the most unique application for radiation sterilization. Ionizing radiation is clearly the best and often the

only way to sterilize these materials. Tissue transplants given by a donor to a recipient may include heart valves, blood-vessels, peripheral nerves, cornea, bone and bone-fragments, cartilage, fascia lata and dura mater, tendons and skin. The most promising applications are the transplantation of aortic valves and bones²¹⁻²⁴.

The relatively low volume of these materials, however, can only justify the use of small hospital irradiators in the proximity of the donors.

Blood and blood derivatives constitute another exciting group of potential candidates for radiation sterilization. The need for safe blood preparations is obvious, especially with the increasing occurrence of viral hepatitis (both infectious and serum) which is a constant danger to recipients of blood and blood components. The causative agent(s) of this disease is estimated to be present in about 2% of the population. Blood derivatives made from pooled blood are making the danger even greater¹⁰.

Some efforts to sterilize blood preparations by radiation have been made. Sterilization of whole blood is not practicable, due to the profuse haemolysis caused. Blood components, like plasma and plasma proteins, fibrinogen and immunoglobulin-G have been reported to withstand sterilization by radiation virtually unchanged, particularly if lyophilized.

Although, irradiated blood derivatives would probably constitute good candidates for radiation sterilization in major volumes by pharmaceutical companies, the question of whether hepatitis-free blood preparations can be obtained following radiation has not yet been answered unambiguously.

Factors affecting developments in radiation sterilization

Introduction of the radiation sterilization technique and general acceptance of radiosterilized medical products are influenced by several factors, such as:

- radiation chemistry and radiation microbiology research;
- the health system and medical care of the population;
- developments in the chemical industry;
- advances in radiation technology;
- economical aspects;
- environmental considerations;
- legislation and regulatory requirements.

Many of these factors, in particular the advances in radiation technology, the economics of radiation sterilization, and the knowledge of the physical and chemical effects of ionizing radiation, will be considered in detail by several lecturers of this Conference. Therefore, I will restrict my presentation to a brief discussion of the other factors.

Results of radiation microbiology research

It has already been mentioned, that the ability of ionizing radiation to kill bacteria was widely known in the first quarter of this century. However, a number of details important to the application of radiation in sterilization practice, such as the quantitative relationship between the dose delivered and the microbicidal effect observed, the relative radiosensitivity of different microorganisms, the influence of environmental conditions prevailing during and after irradiation, the quality of radiation, were only clarified in a series of experiments in the 1950's²⁵.

a) Dose-effect relationship in bacterial killing

By irradiating a suspension of microorganisms with varying doses of radiation and determining, in each case, the fraction of cells that retain the ability to form colonies after exposure, a dose-survival curve can be constructed. For convenience, it is usual to plot the logarithm of the surviving fraction of cells against the radiation dose. This semi-logarithmic plotting has shown up three types of survival curves first described by Gunter and Kohn in 1956: exponential, sigmoidal and composite (Figure 4)^{26,27}.

A dose-survival curve can be characterized by two numbers: one giving the slope of the straight line and the other the size of the "shoulder". Of these two parameters the most frequently used single value is the slope of the linear part of the curve, and this is usually expressed in experimental radiation biology as the D_0 (or D_{37}), i.e. the dose needed to reduce the surviving cell number from 100 to 37. In other words, D_0 is the dose needed to deliver on average one lethal event per cell, or, more accurately, the final lethal event per cell, when survival curves have "shoulders"²⁸.

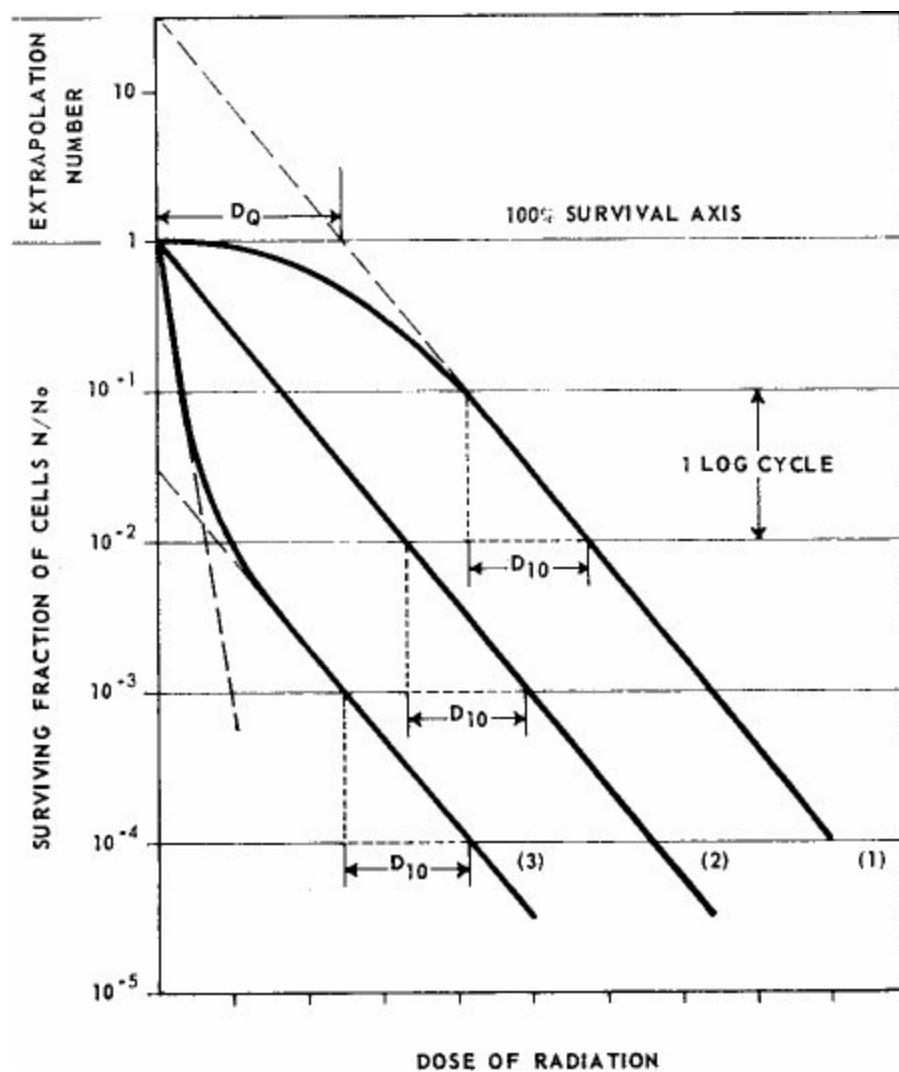

Figure 4. Hypothetical survival curves of irradiated bacteria: Curve (1) sigmoidal, curve (2) exponential, and curve (3) composite.

For many practical applications of radiation effects, like sterilization of medical equipment, food and feed products, radiation pasteurization, inhibition of sprouting in stored root crops etc., another dose value is used in preference: D_{10} or the "decimal reduction dose", which is the dose required to reduce the population by a factor of 10.

Clostridium novyi	Paper discs	220
Clostridium sporogenes	Paper discs	220 — 270
Clostridium welchii	Paper discs	270
Clostridium tetani	Paper discs	220 — 330
Clostridium botulinum	Phosphate buffer	130 — 340

Not only is there an obvious difference in inherent resistance between bacterial species, but even between different strains of the same species. In addition, there are a number of factors concerned with the physiological state of the organisms themselves, with the environmental conditions under which the organisms are irradiated, and with the characteristics of the irradiation itself, which can markedly influence the radiation sensitivity of the micro-organisms (Table VIII)^{33,34}.

Table VIII. — Factors other than genotype of bacteria influencing radiosensitivity

Factors affecting D ₁₀	Effects
I. <i>Physiological state of bacteria at the time of irradiation</i>	
Growth-phase	Higher resistance in the stationary phase
II. <i>Environmental conditions during irradiation</i>	
Oxygenation	Oxygen enhancement ratio (OER) for vegetative bacteria: 2.5 - 4.5 and for bacterial spores: 2-3
Water content	Increased resistance when vegetative bacteria are dried, but fully hydrated bacterial spores were found more resistant than very dry spores
Chemicals present	Protective agents decrease, sensitizing agents increase radiosensitivity
Temperature	Low temperature increases resistance of vegetative bacteria, but has little effect on spores; high temperature is synergistic with radiation for both vegetative bacteria and spores
III. <i>Environmental conditions after irradiation</i>	
Growth media	Conflicting data with regard to the effect of post-irradiation growth conditions on vegetative bacteria; no demonstrable effect on spores
Temperature	Temperature below optimal for growth seems to promote recovery of vegetative bacteria; spores are sensitized to subsequent heating by irradiation
IV. <i>Factors concerned with the radiation itself</i>	
Quality (LET) of radiation	Only low LET radiation are used, such as X-rays, gamma-rays and accelerated electrons
Dose rate	High dose rate may result in less efficiency if the oxygen is used up faster than it can be replaced (thus accelerated electrons are less efficient than cobalt-60 gamma-rays)
Dose fractionation	Decreased lethal efficiency for repair proficient vegetative cells, e. g. <i>M. radiodurans</i> (hazard of inducing increased radio-resistance!); increased efficiency for very dry vegetative cells and spores; and unchanged efficiency for spores air dried or in non-liquid medium.

The radiation sensitivity of animal *viruses* is believed to be lower than the sensitivity of bacteria or bacterial spores. The fully dry virus is the least sensitive; as hydration proceeds the sensitivity increases. Single-stranded simple viruses are more sensitive than double-stranded complex structures, and their inactivation curves conform to a first-order type of kinetics. For viruses of very simple structure, the inactivation of infectivity increases proportionally with the increasing molecular weight of their nucleic acid³⁶.

Table IX. — Radiosensitivity of some viruses

Virus ³⁸	Approximate ³⁹ size, mμ	Irradiation medium	D ₁₀ , Mrad	Ref.
---------------------	------------------------------------	--------------------	------------------------	------

coxsackie	10 — 30	Eagle's + 2% FBS	0.35 — 0.55	[37]
		water	0.08 — 0.21	[37]
echo		Eagle's + 2% FBS	0.37 — 0.68	[37]
		water	0.11 — 0.21	[37]
polio		Eagle's + 2% FBS	0.38 — 0.65	[37]
		water	0.07 — 0.24	[37]
		lyophilized	0.32*	[34, 40]
		PBS frozen	0.55	[41]
FMDV		Hanks' + 2% BS	0.62	[42]
SLE	40 — 60	PBS frozen	0.55	[41]
VEE		Borate saline frozen	0.40	[43, 44]
WEE		PBS frozen	0.45	[41]
rubella		M-199 frozen	0.44 — 0.67	[45]
Newcastle (NDV)	150	Eagle's + 2% FBS	0.49 — 0.56	[37]
reovirus	70	Eagle's + 2% FBS	0.41 — 0.49	[37]
influenza	80 — 120	Eagle's + 2% FBS	0.43 — 0.56	[37]
		water	0.06 — 0.25	[37]
		lyophilized	0.15*	[34]
		saline	0.05	[46]
DEOXYVIRALES				
polioma	40	Eagle's + 2% FBS	0.36 — 0.51	[37]
		Eagle's + 10% HS frozen	5.30	[37]
		PBS + 1% CS room temp.	0.07	[47]
adenovirus	72	Eagle's + 2% FBS	0.38 — 0.61	[37]
herpes simplex	180 — 200	Eagle's + 2% FBS	0.39 — 0.47	[37]
vaccinia	220 — 280	lyophilized	0.09*	[34]
		PBS frozen	0.28	[41]
		10% BS frozen	0.16/0.53 (Liphasic curve)	[48, 49]

Gamma-radiation inactivation rate studies were performed by Sullivan et al. (1971) on 30 viruses suspended in Eagle's minimum essential medium (MEM) containing 2% foetal bovine serum. The destruction of virus populations followed a first-order reaction law. The average dose of gamma-radiation necessary to reduce the number of viral PFU/ml by 90% ranged from 0.39 to 0.53 Mrad. These values agree with published D_{10} -values for other viruses in the liquid state. Viruses in the frozen state, however, have been reported to require a greater radiation dose for inactivation and had higher D_{10} -values. The D_{10} -values were also significantly affected by the suspending media. At least a threefold difference was noted when D_{10} -values of the same viruses suspended in distilled water and in Eagle's

MEM were compared (Table IX)³⁷.

Yeasts and *molds* appear to be about as sensitive to radiation as non-sporeforming bacteria. There is a substantial variation in sensitivity, depending on the species. Dose survival curves of asexual spores of species of important genera of fungi show large differences in resistance to radiation. It is noteworthy, however, that no fungus spore studied so far equals the resistance of the most important spore forming bacteria, such as *Cl. botulinum*, *B. subtilis*, or of the *M. radiodurans*. Accordingly, a radiation treatment sufficient to inactivate bacterial contamination will normally eliminate fungal contamination, too (Table X).

Table X. — Radiosensitivity of some fungi²⁵

Organism	D_1 , krep*
YEASTS AND YEAST-LIKE FUNGI	
<i>Saccharomyces ellipsoideus</i>	700
<i>Saccharomyces cerevisiae</i>	900
<i>Torula cremoris</i>	500
<i>Torula histolytica</i>	1.000
<i>Candida albicans</i>	1.000
<i>Candida krusei</i>	1.150
MOLDS AND MOLD-LIKE FUNGI	
<i>Aspergillus niger</i> (spores)	320
<i>Aspergillus fumigatus</i> (spores)	220
<i>Penicillium notatum</i>	220
<i>Penicillium camembertii</i>	140

* D_1 = Inactivation dose, the lowest radiation dose at which all the samples irradiated are sterile.

The radiation sensitivity of fungus spores is influenced by genetic factors and also by the number of cells in a spore (effect of multicellularity), the number of nuclei per cell (effect of multi-nuclearity), and the number of sets of chromosomes (effect of ploidy). Heating and oxygenation during irradiation strongly increase the sensitivity of fungus spores. According to data published by Sommer in 1973, the D_{10} -values for fungi fall in the range of 0.015 to 0.100 Mrad. It is very interesting that the unicellular yeast organisms have been found to be more resistant to radiation than the spores of spore-bearing molds⁵⁰.

It appears from a search of the literature that an immense quantity of data has accumulated on the radiosensitivity of a wide variety of micro-organisms since the publication of the first series of papers on this subject in 1956. Unfortunately, many of these data have been obtained under experimental conditions which differ considerably from that of the radiation sterilization practice. Therefore, a systematic study on the radiosensitivity of micro-organisms of interest for public health, carried out under conditions that apply in the radiation sterilization of medical products, is still needed and a critical review of the literature would be of great value.

The exponential nature of the dose-survival relationship involves an important concept — that the inactivation of cells by radiation (and this is also valid for other sterilizing agents) follows a probability law. After exposure to a particular dose, however large, there is always a probability of some cell surviving, although this probability might be extremely small. Realization of this fact leads logically to the conclusion that the effectiveness of a sterilization process can only be described in terms of probability level or degree of sterility, or in terms of probability level or degree of contamination⁵¹. Thus, the calculation of a sterilizing dose (for a given set of environmental conditions) will depend on:

- (i) the final degree of contamination that can be tolerated in a given application;
- (ii) the initial count of viable micro-organisms; and
- (iii) the radiosensitivity of the contaminating organisms under the conditions of the sterilizing process.

At the present time, a *level of sterility* of 0.999999 is commonly used as a basis for the design of a sterilization process for medical devices, drugs and other objects produced by the health industries. This means that the non-sterile rate is expected to be 10^{-6} organism per article. According to this criterion, an industrial operation involving a sterilization process should ensure that not more than one single microorganism survives on one million items sterilized^{52,53,54}.

To achieve this level of sterility, the microbial purity of products and the radiosensitivity of the contaminating micro-organisms have to be taken into account.

Until a few years ago, very little was known about the importance of the *microbial purity of products*. Only the extensive microbiological studies carried out in connection with the use of radiation for sterilization have provided some information concerning the variety and number of micro-organisms found on different disposable items prior to sterilization. In the investigations reported by Tattersall, disposable syringes were tested at monthly intervals over a 12 month period. Nearly 25% of these syringes were contaminated between 0 and 10 organisms, and 70% with less than 100. The greatest count observed was 852 on one syringe. The organism most frequently encountered was *Staphylococcus aureus*, but some aerobic spore-formers were also found⁵⁵.

The level and type of pre-sterilization bacterial contamination on plastic hypodermic syringes, taken from the production lines of three large industrial firms manufacturing disposable medical products in the United Kingdom, were examined over a period of 15 months, and the results reported by Cook and Berry. Among 964 syringes tested, only one contained over 1000 aerobic microorganisms (1133), and 91.4% had less than 100, of which 23.4% were totally sterile before being subjected to the radiation sterilization process. Of 610 syringes assessed for contamination by anaerobic micro-organisms, one contained 4275 organisms, three more had between 100 and 1000 organisms, but 488 (80%) were uncontaminated by anaerobes.

The average number of organisms per contaminated syringe differed among the three manufacturers.

The most common organisms found on the 62 more heavily contaminated syringes were Gram-positive, coagulase negative cocci. Diphtheroids were also commonly found, as were a large number of different organisms of variable morphology. Fungal contamination of syringes appeared to be seasonal, with the highest incidence seen in April and May⁵⁶.

A total of 1678 hypodermic syringes from a single producer were studied by Christensen et al. An average germ number of 3.5 to 10.8 per disposable syringe was found, and only nine syringes had

higher counts than 100, up to a maximum of 294. On 297 donor sets from another producer, the average count varied in the range of 0.3 to 61, the highest count being 840 (ref. 57).

An interesting study has been reported by Artandi on the microbial contamination of sutures prior to sterilization. A total of 5,102 dry sutures of various types were tested and 17,872 colonies were found on 1563 positive tests: 893 had only one colony, 670 had more than one, of which 87 had more than 12 and 10 had over 500. The contaminants were mainly micrococci and gram-positive spore-forming rods with a few molds. The identified contaminants were *Staph. epidermidis*, *Staph. aureus*, *Sarcina*, *Streptococcus*, *B. subtilis* and *B. cereus*⁸.

The ratio of the initial count of viable micro-organisms and the final degree of contamination which can be tolerated is called the *inactivation factor*. The sterilizing dose necessary to reduce the initial count by the estimated inactivation factor equals the D_{10} -value of the contaminating micro-organisms multiplied by the exponent of the inactivation factor, if the survival curve is a simple exponential function. For example, the D_{10} -value of *Staph. aureus* is 18 krad. A radiation dose of 144 krad would be expected to result in a reduction of the presterilization number of these bacteria by a factor of 10^8 .

In the event that the survival curve of the micro-organisms has a shoulder, the quasi-threshold dose should be added to the dose-value calculated in the foregoing way.

In practice, however, the product is rarely contaminated exclusively by a pure culture of micro-organisms. In most cases, a mixture of various organisms has to be inactivated and, as the most resistant organisms nearly always represent a small fraction of the total contamination flora, the inactivation curve will proceed steeply at the beginning and less steeply later on (see the type 3 curve on Fig. 4). If a large inactivation factor is desired, i.e. when only a small risk of having surviving organisms can be tolerated after a sterilization procedure, the number and type of the most resistant organisms will determine the sterilizing dose needed.

As a result of a very thorough investigation, a dose of 2.5 Mrad has been established, and almost universally chosen, as the sterilizing dose for medical products to provide a level of safety equal to that of the conventional sterilizing methods.

This dose value has been derived from experiments in which a large number of organisms were inoculated into a number of items. These were then irradiated at different dose levels and tested for sterility in the usual way. The lowest dose at which no survivors were found, i.e. the *inactivation dose*, was increased by a safety factor to obtain the *practical sterilizing dose*²⁵.

It is gratifying to know that the commonly accepted 2.5 Mrad sterilizing dose, established about 15 years ago and used in the majority of radiation sterilization plants all over the world, except for a limited number of countries, has proved to be satisfactory.

Based upon their own experience of the initial contamination of medical equipment produced for radiation sterilization, and on the extreme radioresistance of some micro-organisms isolated from dust, the Scandinavian public health authorities recommend a minimum dose of radiation of 3.5 Mrad, if the average initial count is below 50 per item. In cases where the average count is between 50 and 500, a dose of 4.5 Mrad, and between 500 and 5000 a dose of 5.0 Mrad, are recommended as minimum sterilizing doses⁵⁸.

In the field of radiation microbiology research having a direct bearing on progress in radiation sterilization practice, some intriguing problems still remain to be studied and answered, such as:

- the significance of naturally occurring bacterial strains with exceptionally high radioresistance (e.g. *Micrococcus radiodurans*, *Micrococcus radiophilus*);
- the possibility of selecting radioresistant lines from a population originally of heterogeneous radiosensitivity;
- the risk of inducing increased radioresistance in microorganisms by repeated irradiation with substerilizing doses.

Other factors influencing development

a) The health system and medical care of the population

During the post-war period a general trend could be noticed in the development of national health systems. This trend is based on the concept that a right to health is universal and total and that it is the State's responsibility to protect, promote and restore the health of its population. In some countries health services are nowadays provided, essentially free of charge, while in other countries a substantial part of the financial burden of health services is born by various types of health insurance⁵⁹. The population-wide medical coverage, of course, has significantly increased the demand not only for professional and technical personnel, but also for equipment, drugs and other items necessary for providing medical care. Obviously, mass production of disposable medical articles, among them lots of pre-sterilized items, plays an important role in meeting the increased aspirations of the community to have high quality health services.

A great demand for large varieties and amounts of sterile, ready-to-use surgical instruments and equipment has resulted from the increased sophistication in surgical and medical practice; for instance, the introduction of haemodialysis, cardiovascular surgery, kidney transplantation and other interventions of the up-to-date medicine⁶⁰.

Progress in modern sterilization techniques has also been aided by the realization that the conventional sterilizing methods, such as dry heat and autoclaving, formerly believed to be absolutely reliable, have frequently been found not to produce an acceptable level of sterility.

The literature dealing with nosocomial infections acquired in hospital is fairly extensive. Particularly high infection rates have been established due to cross-infection resulting from injections and from the use of inhalation therapy equipment. The total annual cost of such infections is not known, but the cost of nosocomial wound infections in the United States of America was estimated at about US\$ 13 thousand million in 1967¹⁹. Cleaning and sterilizing problems raised by reusable articles make perfect protection against pathogenic germ transmission an illusion. Only a generalized introduction of sterile disposable syringes, needles and other items can reduce the risk of nosocomial infections and thereby the length of stay in hospitals.

Last but not least, the alarming shortage of labour and qualified hospital personnel also tends to favour pre-sterilized disposables. The use of nurses and technical staff in the hospital for cleaning, resterilizing and sorting of reusable syringes, needles, catheters, tubes and a great variety of other equipment is becoming an unacceptable luxury. The Action survey in London has disclosed that a substantial amount of nursing time can be saved by the use of disposables. The survey figures suggest savings of approximately 50 hours per year per bed¹⁴.

b) Developments in the chemical industry

Developments in the chemical industry during and, in particular, after the Second World War, have resulted in an explosion in the manufacture of plastics. Plastics production in the United Kingdom, for example, has increased from just over 0.5 kg per head in 1940 to an approximate average of 20 kg per head in 1967. The world total production of plastics was estimated at about 16 million tons for 1966, over 50% greater than the production of aluminium — and it was rising rapidly.

Gerritser, Head of the Economic Technical Section of the Organization for Industrial Research TNO at the Hague, has prepared a table showing the probable production of plastics up to the year 2000, based on the reasonable assumption that the rate of new discoveries and applications will remain at the level of the past 20 to 30 years, and that the population of the world will rise from its approximate present level of 3.5 thousand million to 7 thousand million by 2000, a fairly widely accepted figure. The following table summarizes his prognostications, as quoted by Couzens and Yarsley⁶¹ (Table XI).

Table XI. — Production of plastics extrapolated to 2000

Material	1966		1985		2000	
	million tons	cubic decimetre per person	million tons	cubic decimetre per person	million tons	cubic decimetre per person
Iron.....	464	18	1130	29	2250	41
Aluminium.....	7.7	0.6	55	4	250	13
Total metals including copper and zinc.....	486	19	1204	33	2535	55
Plastics.....	16	4.2	240	41	1700	212
Rubber.....	3.9	1.2	16	3.4	44	6.6
Totals.....	19.9	5.4	256	44.4	1744	218.6

The striking conclusion is that, by 1985, the volume consumption of iron and other metals will be exceeded by that of plastics. By the year 2000, when the world's population is expected to have doubled, the consumption of plastics will be exceeding that of metals by a factor of almost four.

There is no doubt that with the expanded use of various plastics for manufacturing disposable medical equipment and supplies, and for packaging medicaments, cosmetics, surgical dressings, and other items of medical care, the significance of radiation sterilization will grow.

c) *Environmental considerations*

A factor to be considered arises from the growing concern over the problems of environmental pollution caused by the increasing volumes of solid waste — to which hospitals contribute a disproportionate share. In the United States of America, the per capita generation of solid waste rose from about 2 kg to 2.5 kg during the 15 years between 1955 and 1970. During the same period solid wastes from hospitals rose to 5 kg per day per patient and more.

The problem is further complicated because discarded syringes, needles, scalpels and other disposable surgical instruments are potentially hazardous to the sanitation workers handling them. These disposables, together with other contaminated solid wastes generated as a result of patient

treatment, operating and autopsy procedures, laboratory and research activities, medical support services, etc., create a growing problem for hospitals. According to a recent assessment, a rate of 1.5 to 2 kg per day per patient is the best estimate of current infectious solid waste production¹⁹.

Infectious waste is presently incinerated on site by the majority of hospitals. Incineration is an economically attractive and effective method of disposal as long as it is not prohibited because of its contribution to air pollution. An investigation and analysis of hospital disposal practices indicated that, under such circumstances, radiation sterilization of infectious hospital wastes might be a reasonable option. After the process, the once contaminated waste would be safe for further handling, and could be disposed of in a conventional manner.

d) *Legislation and regulatory requirements*

The ultimate objective of legislation in the field of sterilization is to protect the patients from any harm arising from the use of 'sterilized products'. Accordingly, in case of radiation sterilization, legislation seeks to ensure that the irradiated products are sterile, safe and befitting their intended use. Moreover, licensing of the radiation sterilization facility serves to guarantee that the facility is of safe design, is operated by adequately trained personnel, and that clear and safe operational procedures have been established.

Reasonable and well-conceived regulatory requirements can contribute substantially to the acceptance of this relatively new method of sterilization. On the other hand, unreasonably strict and discriminative legislation for radiation sterilization as compared with that for other methods of sterilization can seriously hamper its development.

By the formulation and publication of a Recommended Code of Practice for Radiosterilization of Medical Products (1967), the intention of the International Atomic Energy Agency was to assist Member States in drawing up appropriate national regulations governing radiation sterilization practices. Many countries have recognized the usefulness of this document, and adopted substantial part of it into their national legislations⁶². An overall revision and updating of the Code has been started and will, hopefully, be completed not later than the end of this year (1974).

References

1. Sztanyik, L. B. and Mukherjee, R. N. (1972). The IAEA's programme based on the utilization of radiobiological effects. 9th Annual Meeting of the European Society for Radiation Biology, Rome, Italy, 26-28 September 1972.
2. Bruch, C. W. and Bruch, M. K. (1971). Sterilization. In *Dispensing of Medication*, ed. Martin, E. W., Mack Publ. Co., pp. 592-623.
3. Macek, T. J. (1973). Biological indicators and the effectiveness of sterilization procedures. In *Industrial Sterilization*. Duke University Press, Durham, N.C., USA, pp. 19-34.
4. Jefferson, S., Roberts, R., Ley, F. J. and Rogers, F. (1968). Industrial applications of ionizing radiations. *Advances in Nuclear Science and Technology*, **4**, 335-383.
5. Sztanyik, L. B. (1972). Review of recent progress made in radiosterilization of medical products (in Hungarian). *Izostechnika*, **15**, 110-134.
6. Antoni, F., Kozinets, G. and Koeteles, G. (1966). Present possibilities and prospects of using ionizing radiation for sterilization in medicine. *Atomic Energy Review*, **4**, 39-61.
7. Ballantine, D. S. (1971). Lectures at the Regional Training Course on the Use of Radiation for Sterilization and Treatment of Biomedical Products organized by the IAEA and held in Buenos Aires, Argentina, 10 October-20 November 1971.
8. Artandi, C. (1974). Microbiological control before and after sterilization: Its effect on sterility assurance. In *Experiences in Radiation Sterilization of Medical Products*. IAEA **159**, 3-14.
9. Jefferson, S. (1973.) Facilities required for radiosterilization. In *Manual on Radiation Sterilization of Medical and Biological Materials*. IAEA, pp. 89-94.

10. Jefferson, S. (1973). Organization of industrial and medical centres for radiosterilization. In *Manual on Radiation Sterilization of Medical and Biological Materials*. IAEA, pp. 95-97.
11. Christen, H. (1969). Einsatz von Radioisotopen für Sterilisierungszwecke. Technical Meeting NUCLEX 69. International Nuclear Industries Fair, 6-11 October 1969, Basel, Switzerland, No. 8/3.
12. Plester, D. W. (1970). The effects of sterilising processes on plastics. *Bio-Medical Engineering*, **5**, 443-447.
13. *Disposable Products for Health & Social Services*. King's Fund Centre, London.
14. Fahlberg, W. J. (1973). The hospital (disposable) environment. In *Industrial Sterilization*. Duke University Press, Durham, N.C., USA, pp. 399-412.
15. Gonda, T. A., Harder, T. J., Strom, E. C., Donnelly, M. E. and Carpenter, T. M. Jr. (1973). Ionizing radiation as a hospital sterilizing and disinfecting agent. Stanford University Medical Center, Stanford, Calif., 1973/SU-326P34-002/.
16. Artandi, C. (1973). Plastic and rubber instruments and apparatus. In *Manual on Radiation Sterilization of Medical and Biological Materials*. IAEA, pp. 187-190.
17. Artandi, C. (1973). Sutures, in *Manual on Radiation Sterilization of Medical and Biological Materials*. IAEA, pp. 173-186.
18. Little, K. (1973). Non-biological materials for implantation and for use in contact with circulating blood. In *Manual on Radiation sterilization of Medical and Biological Materials*. IAEA, pp. 199-206.
19. McKee, R. W., Owzarski, P. C., Butcherite, C. D. and Frymier, J. W. (1973). Feasibility of a large gamma irradiator as a hospital sterilization facility. Battelle Pacific Northwest Laboratories, Richland, Washington, /BNWL-1726 UC-23/.
20. Phillips, G. O. (1973). Medicines and pharmaceutical basic materials. In *Manual on Radiation Sterilization of Medical and Biological Materials*. IAEA, pp. 207-228.
21. Dexter, F. (1973). A review of preparing tissue grafts for surgical use with special reference to gamma radiation. In *Manual on Radiation Sterilization of Medical and Biological Materials*. IAEA, pp. 245-256.
22. Campbell, J. B. and Wright, K. A. (1973). The use of electron sterilization with particular reference to bone and nerves. In *Manual on Radiation Sterilization of Medical and Biological Materials*. IAEA, pp. 257-265.
23. Gibbons, J. R. P. (1973). Surgical Aspects. In *Manual on Radiation Sterilization of Medical and Biological Materials*. IAEA, pp. 267-272.
24. Triantafyllou, N. (1973). Observations on the clinical use of freeze-dried, irradiated allografts in bone transplantation. In *Manual on Radiation Sterilization of Medical and Biological Materials*. IAEA, pp. 273-281.
25. Bridges, B. A. (1964). Microbiological aspects of radiation sterilization. *Progress in Industrial Microbiology*, **5**, 283-326.
26. Gunter, S. E. and Kohn, H. I. (1956). The effects of X-rays on the survival of bacteria and yeast. Part I. *J. Bacteriol.* **71**, 422.
27. Gunter, S. E. and Kohn, H. I. (1956). The effects of X-rays on the survival of bacteria and yeast. Part II. *J. Bacteriol.* **72**, 571.
28. Alper, T. (1971). Cell death and its modification: The roles of primary lesions in membranes and DNA. In *Biophysical Aspects of Radiation Quality*. IAEA, pp. 171-183.
29. Alper, T., Gillies, N. E. and Elkind, M. M. (1960). The sigmoid survival curve in radiobiology. *Nature*, **186**, 1062-1063.
30. Koh, W. Y., Morehouse, C. T. and Chandler, V. L. (1956). Relative resistances of microorganisms to cathode rays. I. Nonsporeforming bacteria. *Appl. Microbiol.* **4**, 143-146.
31. Bridges, A. E., Olivo, J. P. and Chandler, V. L. (1956). Relative resistances of microorganisms to cathode rays. II. Yeasts and molds. *Appl. Microbiol.* **4**, 147-149.
32. Pepper, R. E., Buffa, N. T. and Chandler, V. L. (1956). Relative resistances of microorganisms to cathode rays. III. Bacterial spores. *Appl. Microbiol.* **4**, 149-152.
33. Kumta, U. S. and Lewis, N. F. (1974). Microbiological aspects of radiation sterilization. In *Radiation Sterilization of Medical Products*. ISOMED, Bombay, pp. 37-60.
34. Ley, F. J. (1973). The effect of ionizing radiation on bacteria. In *Manual on Radiation Sterilization of Medical and Biological Materials*. IAEA, pp. 37-63.
35. Rowley, D. B., El-Bisi, H. M., Anellis, A. and Snyder, O. P. (1968). Resistance of Clostridium botulinum spores to ionizing radiation as related to radappertization of foods. Proc. 1st US-Japan Conference on Toxic Micro-organisms, pp. 459-467.
36. Pollard, E. C. (1973). The effect of ionizing radiation on viruses. In *Manual on Radiation Sterilization of Medical and Biological Materials*. IAEA, pp. 65-71.
37. Sullivan, R., Fassolitis, A. C., Larkin, E. P., Read, R. B. Jr. and Peeler, J. T. (1971). Inactivation of thirty viruses by gamma radiation. *Appl. Microbiol.* **22**, 61-65.
38. Lwoff, A. and Tournier, P. (1966). The classification of viruses. *Ann. Rev. Microbiol.* **20**, 45-74.
39. Joklik, W. K. and Zweerink, H. J. (1971). The morphogenesis of animal viruses. *Ann. Rev. Genetics*, **5**, 297-360.
40. Benyesh, M., Pollard, E. C., Opton, E. M., Black, F. L., Bellamy, W. D. and Melnick, J. L. (1958). Size and structure of Echo, poliomyelitis, and measles viruses determined by ionizing radiation and ultrafiltration. *Virology*, **5**, 256-274.
41. Jordan, R. T. and Kempe, L. L. (1956). Inactivation of some animal viruses with gamma radiation from cobalt-60. *Proc. Soc. Exp. Biol. Med.*, **91**, 212-215.
42. Polatnick, J. and Bachrach, H. L. (1968). Ionizing irradiation of Foot-and-Mouth Disease Virus and its ribonucleic acid. *Arch. ges. Virusforschung*, **23**, 96-104.

43. Gruber, J. (1970). Purification, concentration, and inactivation of Venezuelan Equine Encephalitis Virus. *Appl. Microbiol.* **20**, 427-432.
44. Reitman, M. and Tribble, H. R. Jr. (1967). Inactivation of Venezuelan Equine Encephalomyelitis virus by γ -radiation. *Appl. Microbiol.* **15**, 1456-1459.
45. Kenny, M. T., Albright, K. L., Emery, J. B. and Bittle, J. L. (1969). Inactivation of rubella virus by gamma radiation. *J. Virol.* **4**, 807-810.
46. Polley, J. R. (1961). Factors influencing inactivation of infectivity and hemagglutinin of influenza virus by gamma radiation. *Can. J. Microbiol.* **7**, 535-541.
47. Latarjet, R., Cramer, R. and Montagnier, L. (1967). Inactivation by UV-, X-, γ -radiations of the infecting and transforming capacities of polyoma virus. *Virology*, **33**, 104-111.
48. Decker, C., Guir, J. and Kirn, A. (1969). Infectivity and capacity for DNA replication of vaccinia virus irradiated by γ -rays. *J. gen. Virol.* **4**, 221-227.
49. McCrea, J. F. (1960). Ionizing radiation and its effects on animal viruses. *Ann. N.Y. Acad. Sci.*, **83**, 692-705.
50. Sommer, N. F. (1973). The effect of ionizing radiation on fungi. In *Manual on Radiation Sterilization of Medical and Biological Materials*. IAEA, pp. 73-79.
51. Bridges, B. A. and Powell, D. B. (1964). Sterilization of medical equipment and pharmaceutical products. In *Massive Radiation Techniques*, ed Jefferson, S., George Newnes Ltd., London, pp. 61-97.
52. White, J. D. M. (1973). Biological control of industrial gamma radiation sterilization. In *Industrial Sterilization*. Duke University Press, Durham, N.C., USA, pp. 101-116.
53. Bruch, C. W. (1973). Factors determining choice of sterilizing procedures. In *Industrial Sterilization*. Duke University Press, Durham, N.C., USA, pp. 119-123.
54. Pflug, I. J. (1973). Heat Sterilization. In *Industrial Sterilization*. Duke University Press, Durham, N.C., USA, pp. 239-282.
55. Tattersall, K. (1965). Problems of microbial contamination in prepacked preparations. In *Ionising Radiation and the Sterilization of Medical Products*. Taylor and Francis Ltd., London, pp. 15-21.
56. Cook, A. M. and Berry, R. J. (1967). Pre-sterilization bacterial contamination on disposable hypodermic syringes: Necessary information for the rational choice of dose for radiation sterilization. In *Radiosterilization of Medical Products*. IAEA, pp. 295-305.
57. Christensen, E. A., Mukherji, S. and Holm, N. W. (1968). Microbiological control of radiation sterilization of medical supplies. I. Total count on medical products (disposable syringes and donor sets) prior to radiation sterilization. Risö Report No. 122.
58. Christensen, E. A. (1973). Hygienic requirements, sterility criteria and quality and sterility control. In *Manual on Radiation Sterilization of Medical and Biological Materials*. IAEA, pp. 131-152.
59. *Health Systems*. Scientific Publication of PAHO No. 234, Washington, D.C., 1972.
60. Ducel, G., Scheidegger, Cl. and Banderet, G. (1973). Sterilization experience in the University Hospital of Geneva. In *Industrial Sterilization*. Duke University Press, Durham, N.C., USA, pp. 371-397.
61. Couzens, E. G. and Yarsley, V. E. (1968). *Plastics in the Modern World*. Penguin Books Ltd., England, pp. 341-346.
62. Crawford, C. G. (1973). Legal Aspects. In *Manual on Radiation Sterilization of Medical and Biological Materials*. IAEA, pp. 153-161.

FIRST SESSION

Chairmen

N. W. Holm

Z. P. Zagórski

Moderator

S. Nablo

Introduction to Ionizing Radiation Equipment

N. W. Holm

*Danish Atomic Energy Commission,
Reserch Establishment Risø, Denmark.*

It is a great pleasure and indeed a very great honour for me to chair this session on ionizing radiation equipment, a subject to which I have devoted a deep interest and a fair amount of work for more than 15 years.

I am also somewhat proud when I look through the program for today. At a White House dinner for a number of eminent scholars, artists, and scientists, the late President Kennedy made the observation that the participants in the dinner together made up for more brainpower and knowledge than had ever been assembled in the Blue room since President Jefferson dined there alone. I do not know how much President Jefferson knew about radiation equipment, but I do know that the combined knowledge within this field of our speakers today surpasses — by a large margin of safety — what can be found elsewhere, and I am looking forward to the lectures and the ensuing discussions between the speakers and the audience. We happen to have with us a most distinguished audience. I have been told that our 130 participants are representing more than 25 nations. Not only that; they are leaders in a number of sophisticated scientific disciplines such as radiation physics and chemistry, bacteriology, pharmacy, medicine, and radiation technology, to name but a few. The exchange of information, which is going to take place at this meeting will certainly be of great significance in the further development of radiation sterilization.

Radiation sterilization is among the modern technologies available to the medical profession and to society. It is a much beloved dogma that modern technology progresses with something like the speed of light. Communication systems, means of transportation, computers, kitchen utensils, and agents for disinfestation (of weeds, insects and human beings) are being developed and produced with a speed hitherto unheard of; it has been shown, e.g. that 50% of the products sold by the pharmaceutical industry today were not even invented only ten years ago. One gets the impression that the production people keep a constant watch on the research people to make certain that things invented today can be produced tomorrow and sold — at the latest — the day after tomorrow, if the annoying situation does not arise, that a need has first to be created. In the latter case one may have to allow for a full extra day.

Practice can show something different, even with a science based industry like medical sterilization, as I shall now try to demonstrate.

Of the types of ionizing radiation applied for radiation sterilization, electromagnetic radiation was observed already in 1895 by the German scientist W. Röntgen. As he bombarded a block of heavy metal with fast electrons, radiation with a high capability of penetration escaped from the block. This type of radiation is known today as X-rays or röntgen-rays. Already in 1896 a certain Dr. Minch published a paper in a medical journal in Munich informing his colleagues that such rays could be

utilised for killing bacteria.

At this point you may ask what in the world has taken place in the meantime, i.e. up to 1956, when the first industrial applications saw the light of day.

To begin with there was no explicit need in those days for such a sophisticated sterilization method. The therapeutic capability was certainly limited compared to what we can achieve today, and the needs of the hospitals in terms of sterile equipment were modest, if we compare it to the needs of a modern hospital. Today's use of disposable medical equipment is partly a result of the progress in polymer technology and partly an answer to the need for decreasing the risk of infection from one patient to another in the hospitals. This need has been further emphasized by the advances in modern surgery and medicine which allow successful treatment of very sick patients, who earlier could not be helped. Also, economical considerations enter the picture. The high wages earned by skilled personnel prohibit the hospitals from relying solely on resterilization of conventional equipment. Radiation sterilization comes in handy; owing to the penetrating ability of the radiation one can sterilize the end product efficiently in a safe packaging, which can maintain the sterility.

So much for the need. It could not, however, be satisfied by the techniques available to Röntgen; the penetrating ability and the intensity of the radiation was insufficient. Neither would Madame Curie's radium be of much help as it was much too expensive.

The industrial radiation facilities we operate today are based either on manmade radioisotopes, which are produced in nuclear reactors or on electron accelerators. Today's reactor technology, which is derived basically from the accelerated weapon research during and after the second world war allows the production of cobalt-60 at a reasonable, albeit, not insignificant cost.

The microwave electron accelerator, which is the preferred type of accelerator for radiation sterilization of bulky materials, was at the stage of final design already several years before the war; what was needed to carry through with the construction was a powerful high-frequency generator. Even the fundamental knowledge upon which to design such a generator was available, but the incentive to finance it was lacking. Later during the war this knowledge was picked up and utilized for the construction of radar equipment, and the technological progress derived from the wide utilization of such systems during and after the war finally gave the accelerator designers the possibility of carrying their projects through.

Around 1956 a team of daring young men at Ethicon, a daughter company of Johnson & Johnson, started to apply these new monsters for radiation sterilization of sutures. The first industrial electron accelerators were fragile and bug-ridden, as were the first industrial cobalt-60 plants. Cobalt-60, which was earlier a byproduct from nuclear reactors producing plutonium for nuclear weapons, is now being produced in megacurie quantities from certain types of electricity generating nuclear power plants, and electron accelerators based on a variety of accelerating principles are available from a variety of companies in a variety of countries.

I should have liked to go on now and present to you my highbrow ideas on the future development of ionizing radiation equipment, but with due respect to the speakers I shall refrain from doing so. At a certain stage of the second world war, the great statesman Winston Churchill said, "We are not at the end; we are not even at the beginning of the end, but we are perhaps at the end of the beginning". I feel this sentence is very pertinent for radiation sterilization. We are through the tantalizing stage of demonstrating the usefulness of radiation sterilization as a method and radiation equipment as a practical tool. If we continue to maintain high quality standards and guard against slack procedures, I

believe we may expect to witness a fast and continuous growth of the market for radiation sterilized products.

ELIT Type Pulse Electron Accelerators Based on a Tesla Transformer

S. B. Vasserman

Institute of Nuclear Physics, Novosibirsk, U.S.S.R.

In the work reported here, three modifications of accelerators ELIT type are reviewed. They have been developed in the
Abstract: *Institute of Nuclear Physics of the USSR Academy of Sciences, Novosibirsk. These accelerators are designed for various industrial purposes, including sterilization of medical instruments.*

During the last ten years at the Institute of Nuclear Physics of the U.S.S.R. Academy of Sciences in Novosibirsk, the development of particle accelerators for various industrial applications has been carried out in conjunction with its main activity in fundamental research in experimental and theoretical physics.

This activity had developed in several directions and the development of accelerators of the ELIT type is a part of this large program. These accelerators are patented in a number of countries.

The ELIT accelerator is a high voltage pulsed generator with coupled circuits (Tesla transformer) with natural frequencies in the range of tens to hundreds kHz, the high voltage being applied to an accelerating tube.

The first accelerator of this type was manufactured in 1966^{1,2}. After that, a number of installations were made for various organizations in the USSR and abroad within the energy range 0.5-2.5 MeV^{3,4}. These accelerators were mainly designed for research purposes. Their mean power did not exceed 1 kW. Possibilities for creating accelerators at substantially higher mean powers were discussed then but systematic work on obtaining mean power in the beam of about 5-10 kW was practically started only in 1972. This level of power was obtained in continuous operation in 1973 and at the present time the major attention is being focused on the problem of the machine reliability.

The possibility of making use of ELIT type accelerators in medical instruments and material irradiation has been studied on the installations at the Nuclear Physics Institute, Novosibirsk, by many organizations of the USSR and Johnson & Johnson, USA. Some users made irradiation for their own practical needs. As an example, one large clinic in Novosibirsk irradiated materials which were then used in operations involving heart surgery.

Scheme and structure of the ELIT accelerator

A simplified electric circuit of an accelerator is shown in Figure 1. Storage capacitor (4) of the primary circuit is charged by rectifier (1) through the choke (2). The operating cycle in an accelerator starts after switching thyatron switch (3) on.

The form of the high voltage pulse in the secondary winding of the Tesla transformer (6) and the accelerating tube (7) is shown in Figure 2. After the operating voltage halfwave starting point in time

Δt , a positive pulse from the beam current control unit (8) is applied to the control electrode and a current pulse of duration T passed through the tube.

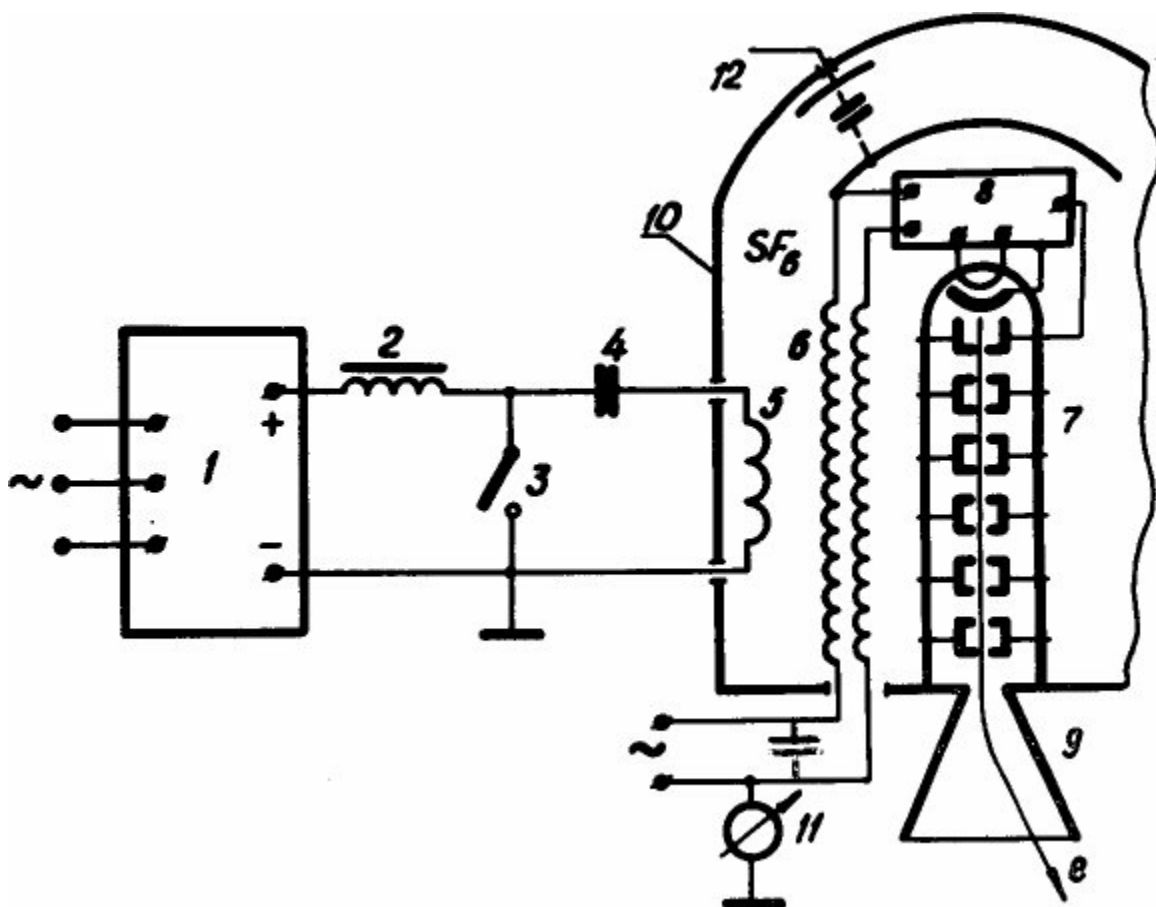

Figure 1. A typical accelerator ELIT circuit: 1. Rectifier; 2. Charging choke; 3. Switch; 4. Storing (primary) capacitor of the Tesla transformer; 5. Transformer primary winding; 6. Transformer secondary winding; 7. Accelerating tube; 8. Beam current control unit; 9. Scanning system; 10. Accelerator tank; 11. Device for a measurement of the mean current value; 12. Capacitive divider for the high voltage measurements.

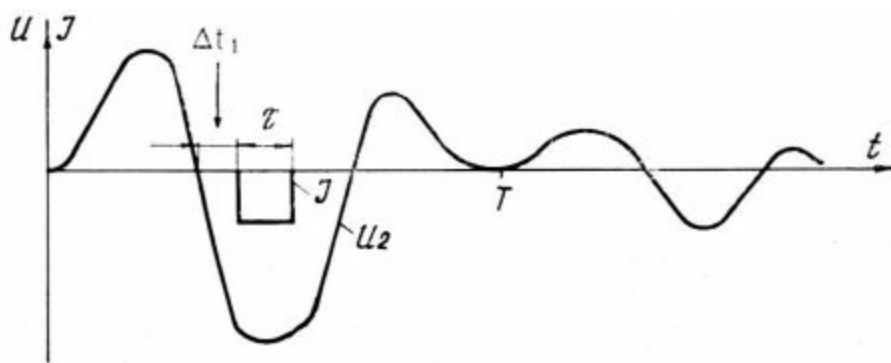

Figure 2. The tube voltage and the beam current forms.

Figure 3 presents the ELIT-2 design. The accelerator is located in tank (1) filled with pressurized gas (SF_6 at 15 atm). In the tank there are the primary winding (2) with ring (6) (as its edge electrode); secondary winding (3) with high voltage electrode (7) and protection screen (5). In the centre of the tank the sectioned accelerating tube with the electron gun control unit (8) are disposed.

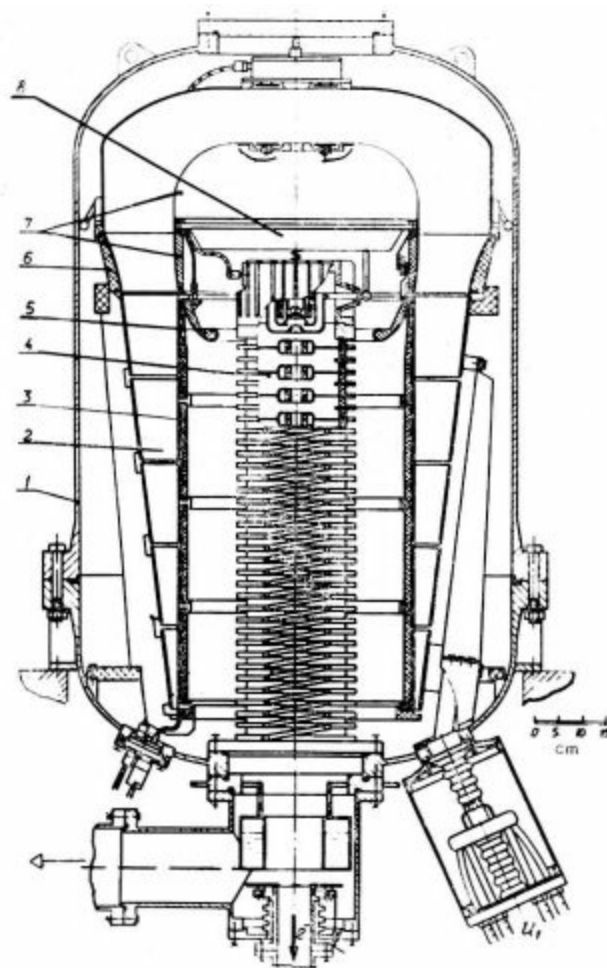

Figure 3. Accelerator ELIT-2 arrangement. 1. Tank; 2. Primary winding; 3. Secondary winding; 4. Accelerating tube; 5. Protecting screen; 6. Edge Electrode of the primary winding; 7. High voltage Electrode; 8. Control unit of the electron gun.

Table 1. — Main Data of Accelerators- Electrical Characteristics

Accelerator type	Rectifier voltage kV	Circuit natural frequencies kHz	Duration of negative halfwave voltage μsec	Duration of beam current pulse μsec	Repetition rate Hz
ELIT - 0.8 A	15	150	3	1	100
ELIT - 1 B	10	65	7	2.5	50*
ELIT - 2	15	55	9	3.5	100

*At the present time tests are started at $f = 100\text{Hz}$.

Vacuum is obtained with a sputter-ion pump with a pumping speed of 200 l/sec with a nitrogen trap. The primary winding is made of copper with five turns in it. It is cooled with water. The secondary winding is made of a single wire covered by polyethylene and put on a frame of organic glass. The secondary winding has 800 turns. This winding has two layers in order to transmit power to the electron gun control unit. Both layers have the same number of turns. The winding terminals facing ground are connected to the voltage source (50 Hz, 750 V), which feeds the systems that are inside the high voltage electrode (see Figure 1).

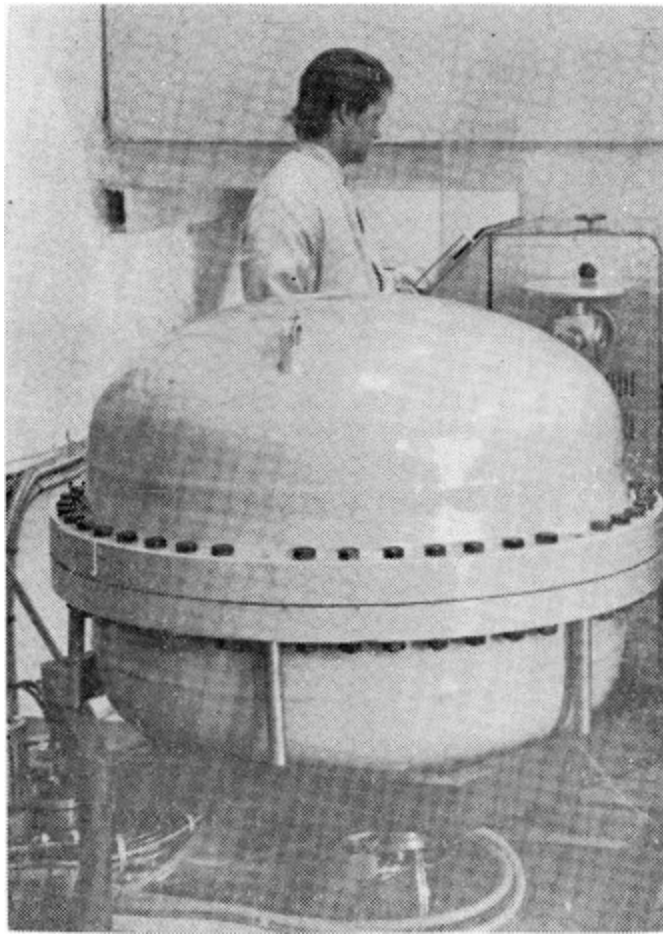

Figure 4. Accelerator ELIT-1B

The high voltage terminal of the secondary winding is connected to the accelerating tube. The electron beam is formed and accelerated in the accelerating tube. The tube is sectional with rubber seals between sections. Insulators are made of an epoxy compound. Metal electrodes are located between insulators. Between adjacent electrodes, resistors are placed outside which allow the charges, intercepted by the electrodes during a pulse, to be leaked to ground in the interval between the pulses. Magnetic lenses are fixed to alternate electrodes. The lenses form the electron optical system of the accelerator. This is a periodical focusing system with permanent magnets.

Accelerators ELIT-0.8A and ELIT-1B are of similar design but with some differences. The accelerating ELIT-0.8A is of welded ceramic and contains no organic materials. Both accelerators have no magnetic focusing of the beam. A view of the accelerator ELIT-1B is shown in Figure 4.

Parameters and experimental data

The main parameters of ELIT type accelerators designed for the industrial use are given in Table 2. The prototype of ELIT 0.8A accelerator was tested in 1972 at the Institute before its delivery to Energy Sciences Inc. in Burlington, Massachusetts, U.S.A. In the U.S.A. this accelerator, with some modification, has undergone continuous tests. At present the improved variant of the accelerator is under production in our Institute.

Table 2. — Main parameters of accelerators

Accelerator type	ELIT - 0.8A	ELIT - 1B	ELIT - 2
------------------	-------------	-----------	----------

Average electron energy in pulse	MeV	0.7	1.1	1.5
Energy spread	%	20	20	20
Average beam current	mA	0.8	2.5	6.5
Mean power	kW	0.5	2.5	10
Pulse current	A	8	20	20
Pulse power	MW	5	20	30
Efficiency	%	60	25	25
Weight of the accelerator itself	kg	150	1000	1300
Tank height	m	0.6	0.9	1.6
Tank diameter	m	0.4	1	1
Electric supply units and its number	m	$0.8 \times 0.8 \times 1.6$	$0.6 \times 0.9 \times 1.8$	$0.6 \times 0.9 \times 1.8$
		1	2	3

Tests of ELIT-1B were carried out in the regime $E = 1.2$ MeV, $P = 2$ kW during 600 hours and in the regime of 1.2 MeV, 2.5-3.0kW with the repetition rate of 50 Hz during 200 hours. At present tests are started with the repetition rate of 100 Hz at 5 kW. The operation period experienced was about 150-200 hours, because of the electron gun. Now the improved variant of an electron gun is prepared for tests. According to experience of these guns operating in other installations the gun has a lifetime of about 500 hours.

Tests of accelerator ELIT-2 were carried out in the regime $E = 1.4 - 1.8$ MeV, $P = 4 - 11$ kW during about 100 hours, that is, the continuous tests are practically only in the beginning stage.

In order to increase the flexibility of the accelerator ELIT-1B for special research applications, we developed a system for beam current control, which can be easily added to the terminal electronics. With this control unit, it is possible to vary the pulse width from 30 nanosec. to 1000 nanosec. from the control console. Rise and fall times of the current pulse are less than 10 nanosec.

Extraction devices of the accelerators have beam scanners which move each pulse along the extraction window, $1/32$ or $1/16$ part of its length. For ELIT-0.8A accelerator, the beam can be distributed as well by an extraction device using a quadropole lens.

Experience obtained during the tests of accelerators mentioned above showed that they are quite simple in operation and in maintenance.

Prospects of the use of ELIT-type accelerators

In spite of the comparatively low mean power of the electron beam in accelerators described above, they have some significant advantages: compactness, small weight of the accelerator, technological simplicity in production and relatively simple maintenance. An important feature of accelerators of ELIT type is its high pulse power. These mentioned features will define the fields of possible industrial use of these accelerators. Medical products irradiation for sterilization purposes may become one of these fields, where these high dose rates can probably be used to advantage.

When we have insured adequate industrial reliability for the ELIT-2 accelerator, at mean power of 10 kW, we will then consider the possibility of an ELIT accelerator design at a higher mean power.

The work on the accelerators described above is carried out by the team of the Nuclear Physics Institute (Novosibirsk) by I. V. Kazarezov, V. F. Kuzenko, V. M. Radchenko, S. B. Vasserman, B. I. Yastreba and others under governing of the Institute's Director-Professor G. I. Budker.

Acknowledgement

The author wishes to thank Dr. S. V. Nablo for his useful discussions concerning this report.

References

1. Abramyan, E. A. and Vasserman, S. B. High current pulse accelerator of electrons, *Atomnaya Energiya*, v. 23, N 7, 1967.
2. Vasserman, S. B. High current pulse electron accelerator at an energy 1 MeV, thesis, 1967.
3. Abramyan, E. A., Vasserman, S. B., Dolgushin, V. M., Egorov, A. A., Kazarezov, I. V., Phillipchenko, A. V. and Yasnov, G. I. Pulse electron accelerator at an energy 3 MeV, report given at the VII Conference on Electron Accelerators, Tomsk, Conference Proceedings, 1970.
4. Abramyan, E. A., Vasserman, S. B., Egorov, A. A., Kazarezov, I. V., Kryuchkov, A. I., Lyubavin, E. P., Radchenko, V. M. and Chertok, I. L. — Report given at the MAGATE Conference on the Use of Powerful Radiation Sources, Munchen, Conference Proceedings, 1970.

Developments in Transformer Accelerators and The Technology of Pulsed Electron Sterilization at Ultra-High Dose Rates

S. V. Nablo

Energy Sciences Inc., 111 Terrace Hall Avenue, Burlington, Massachusetts 01803, U.S.A.

Abstract: *The principles of operation of the transformer accelerator are reviewed. The features of the pulse transformers operating in the “double resonance” mode are presented and compact designs discussed which take advantage of the high insulation strength of materials in the pulsed voltage mode supplied by the transformer. Other approaches to the generation of medium energy pulsed sources are also referenced, covering the dose rate regime from 10^8 to 10^{14} rads/second. Some comparative lethality and degradation studies, conducted over this range, are presented demonstrating the potential advantages of the high sterilization rates offered by this equipment.*

Introduction

The comparative advantages of machine made “ionizing radiation” for industrial processing, including sterilization, have been reviewed at some length in the literature¹. In spite of their oft-cited superiorities as flexible, powerful sources of sterilizing energy, industrial use has been very limited since the pioneering, industrial level studies were reported some four decades ago². Some of the reasons for this lack of acceptance have arisen from the limitations of the available machinery, while others have been associated with in-plant product logistics. I have found that no small degree of confusion exists in the minds of the end-users in selecting the optimum radiation sources for their product needs... there is poor understanding of the physical parameters of all forms of radiation processing, be it ultraviolet, X-ray or microwave; the assessment of the comparative merits and limitations of accelerator vs. radioisotope radiation sources is well beyond the capability of the majority of end-users. Based on the desire to maintain existing product flow patterns many manufacturers prefer to sterilize terminally bulk-packaged goods, (i.e. in shipping cartons) as has been customary with gas sterilization. In these applications gamma irradiators often have an advantage over accelerators because of their greater penetrating power. High energy linacs (> 10 MeV) producing electrons of comparable penetrating power exhibit high capital costs for their throughput capability, which makes them generally uneconomical. Electron beam power is most economical in the range below 2 MeV but machines in this range are not suitable as *general purpose* terminal processors because of penetration limitations (about 1 cm of unit density material at most). As a consequence, the industrial applications of radiation sterilization have been dominated by the radioisotope sources, principally cobalt 60.

On the other hand many, if not most, products can be treated with moderate-energy accelerators at points along the production line where they move as individual items or small aggregates prior to

packing in cartons. Single-pass processing at very high speed is possible, so that only a small quantity of the product need be in the radiation zone at any instant. Thus, the shielded volume can be much smaller than in gamma irradiators having the same throughput. This, together with reduced shield thickness, results in substantially smaller facility size and cost. Indeed facility costs (i.e. building materials and construction labor), which are a larger share of the total investment for gamma irradiators, have been rising more steeply than equipment costs in the U.S., suggesting that accelerators will enjoy an increasing economic advantage.

All of these factors tend to promote the on-line rather than offline, (or terminal), application of electron beam sterilization. It seems clear, however, that these applications will only be realized when it can be shown that significant practical, economic advantages result and suitable equipment is available. For industrial use, "suitable" means compact systems of moderate power output (about 5 kW covers most applications), which offer moderate capital cost and low maintenance. This paper is directed to a review of recent developments in electron machine technology which have particular bearing on their adaptability and compatibility with in-line industrial sterilization.

Some General Design/Application Considerations

Configuration

As with any other energy source for in-line processing, the electron sterilizer represents only one element of a total system and its compatibility with, and cost of integration into, that system must be given careful consideration if satisfactory performance is to be realized. The most critical design parameters are, of course energy (penetration) and power (throughput) while dose rate (current) may be a secondary consideration (see Figure 1).

Figure I. — Electron Sterilization Process Parameters

Penetration	=	Voltage
Treatment Rate	=	Current
Treatment Level	=	Time
Throughput	=	Power

For unilateral treatment, the selection of the appropriate machine energy may be based simply upon readily available depth-dose data³ so that front-surface to back-surface ratios are maintained near unity (Figure 2), or upon more sophisticated electron transport calculations if complex package geometries are involved. The selection of primary operating parameters appropriate to the product range which must be handled, essentially defines the accelerator configuration.

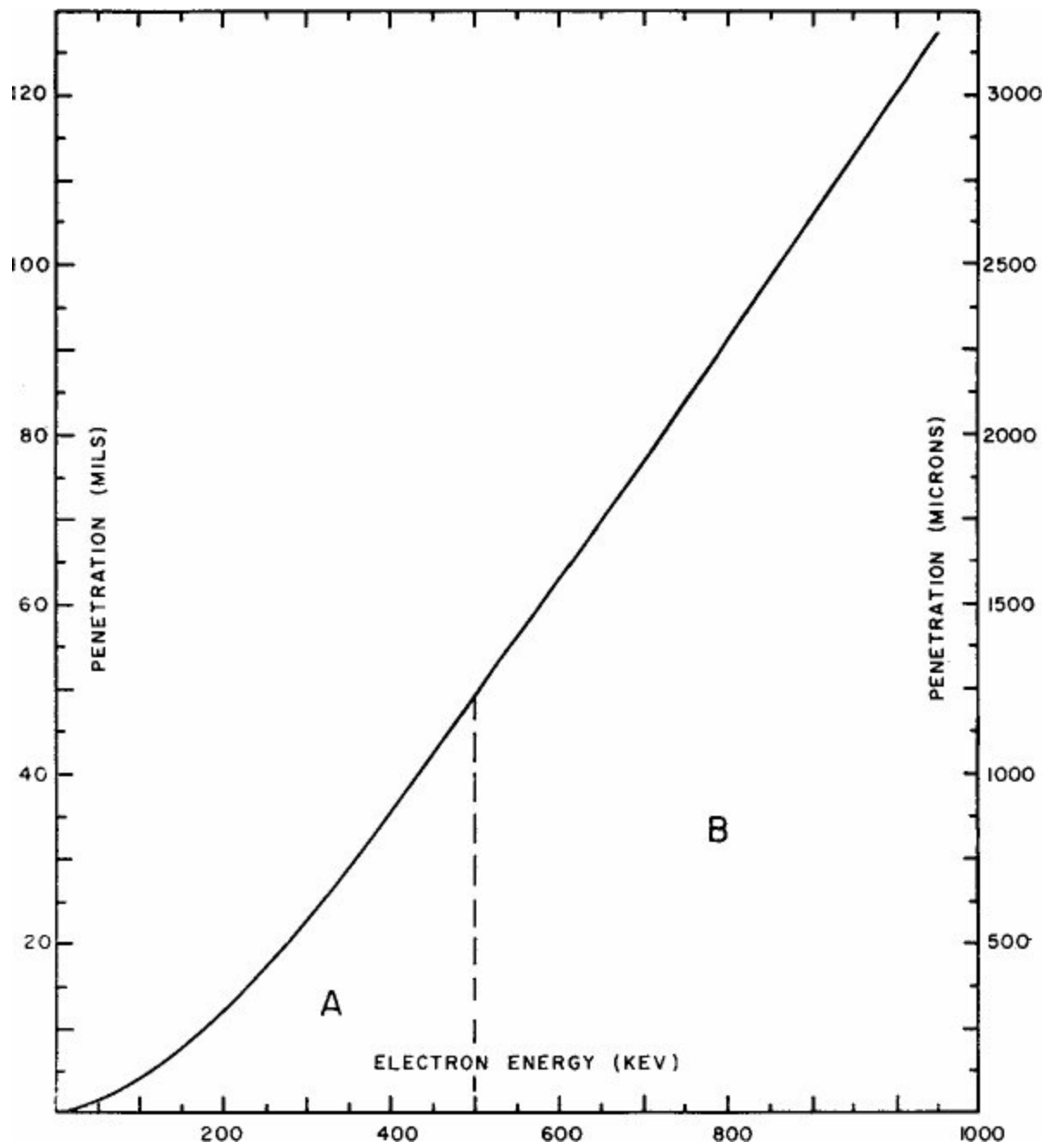

Figure 2. Electron penetration in polystyrene ($\rho = 1.06 \text{ gm/cc}$; front: back dose = 1).

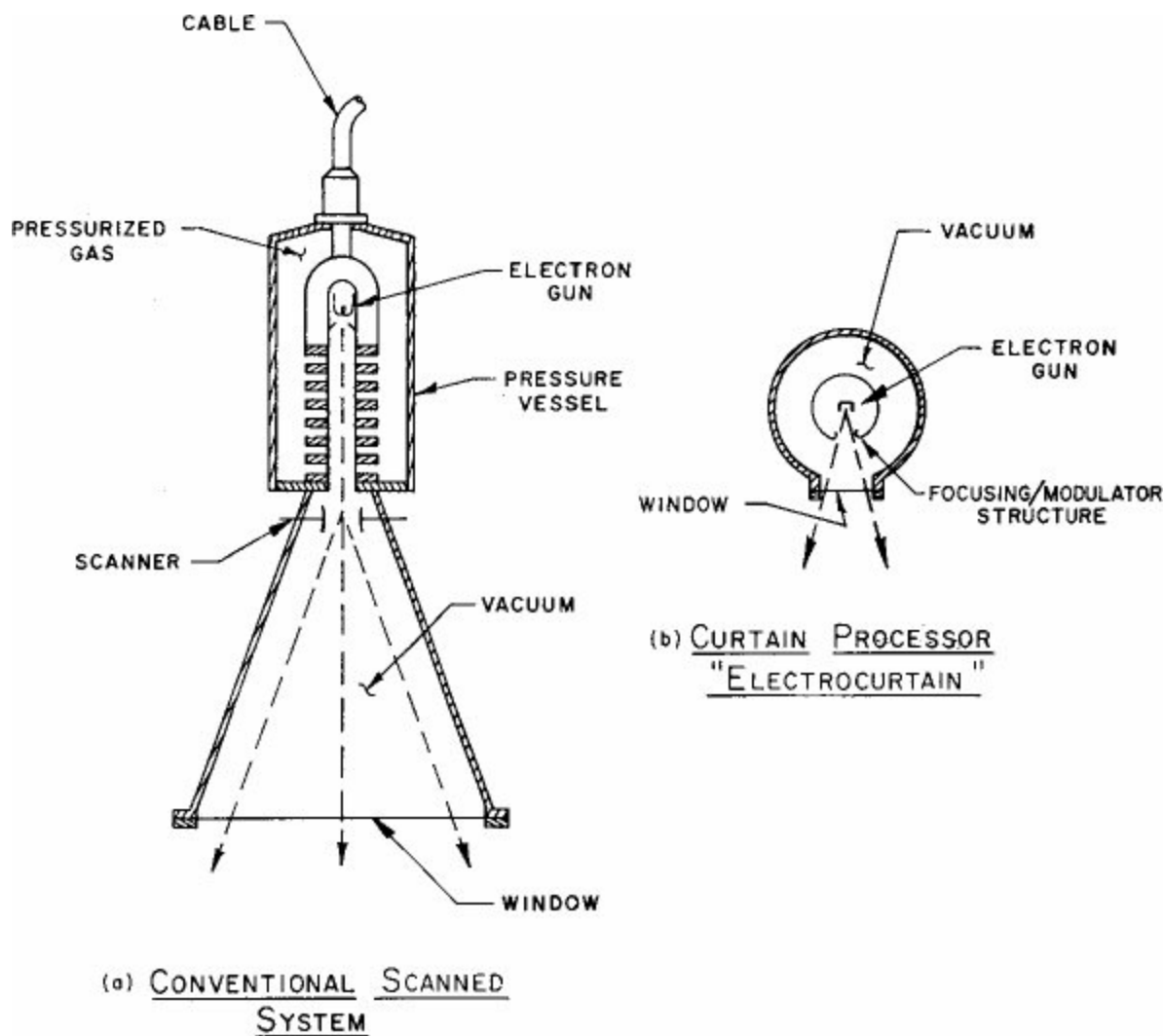

Figure 3. Electron processor geometries.

As one moves up in the penetration required, the configuration may vary markedly as illustrated in Figure 3. Recently developed equipment⁴ of the "tube" or cylindrically symmetric form shown in 3(b), can provide electrons in the energy regime marked A in Figure 2; i.e. up to 500 keV. In this type of machine the electrons are accelerated in a single gap vacuum structure so that relatively compact tube sources (accelerators) result as shown in Figure 4, in this case a 20 cm diameter source which generates strip-type sterilizing fluxes in the 175 keV range. The ease of shielding such a system is obvious.

The limitations of this compact design are dictated by the characteristics of the vacuum dielectric. It is well known that the dc breakdown voltage of single or ungraded gaps above about 1 mm, varies with the square root of the gap... often referred to as the "total voltage effect". Typically for modest sized vacuum insulated systems working in the range of 100-200 kV, gap stresses in the range of 150 kV/cm are achievable⁵; however large derating factors are required to assure uninterrupted (spark-free) operation of large area dc systems. These factors present the practical limitation of 300-500 kilovolts for simple single-gap accelerators of the geometry shown in Figure 3(b). As shown in the range curve of Figure 2, this limits the practical use of these compact units to surface sterilization or the treatment of thin products ($< 100 \text{ mg/cm}^2$).

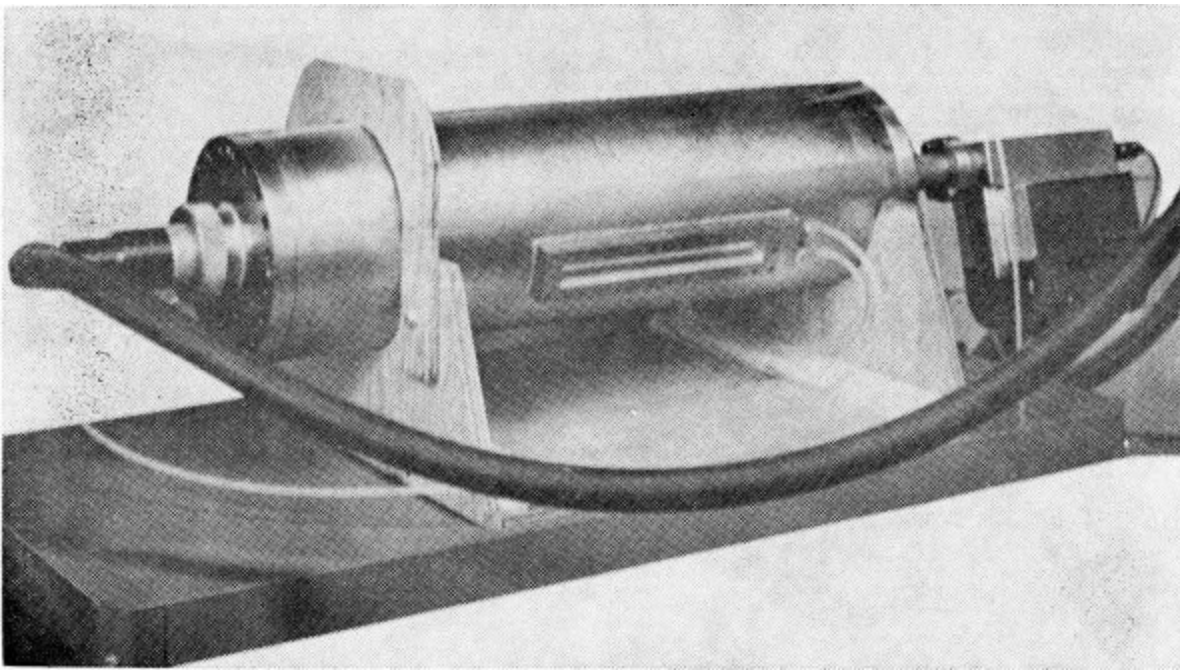

Figure 4. Cable fed Electrocurtain™ (CBS 175).

For the higher energy regime marked B in Figure 2, graded or multi-gap (electrode) acceleration structures must be used as illustrated in Figure 3(a). This geometry in effect takes advantage of the higher insulating strength of the many smaller gaps comprising the multiple-gap acceleration tube — typically rated at 15-20 kV/cm. Since flashover must also be avoided along the exterior of this evacuated tube, it is normally contained in an environment of pressurized gas which provides superior insulating strength. For example, SF₆, at modest pressures (5 atmospheres) will support 150 kV/cm *across large gaps* in the megavolt range⁶.

As shown in Figure 3(a) the geometry is then determined: long cylindrical acceleration tubes with surrounding cylindrical pressure vessels whose volumes will increase roughly as the cube of the operating voltage of the machine. This geometry is further complicated by the need to distribute uniformly the cylindrical electron beam so generated across the product, necessitating the addition of a scanner, either electromagnetic or electrostatic. This further increases the overall machine length since a small angle of incidence must be preserved at the window in order to limit the increased energy loss and scattering of the electrons resulting from the greater “effective” window thickness at the scan edge.

Shielding

When designing an electron sterilization system in region B of Figure 2, the radiation shield can represent a very significant portion of the total cost, (up to 30%). This results from the increased X-ray yield efficiency. The importance of minimizing or tailoring the machine energy to the product penetration requirements has already been stressed — once this is done, the shield cost will vary roughly as the square of the machine dimensions, so that any technique for reduction of the machine size at a given energy can have a very significant effect on the facility cost and its ease of use. In region B, an important choice must be made between local shielding and volume or area shielding; i.e. self-shielding vs. a vault.

In general, the choice is made so as to satisfy industrial environmental standards in the most economical and convenient way. In the U.S., these standards are well defined by OSHA⁷, which

Single user license provided by AAMI. Further copying, networking, and distribution prohibited.

requires that environmental levels of ionizing radiation must be held to under 0.5 mrem/hour for total body exposure, or to under 5 mrem/hour for the extremities. It is usually advantageous to employ local shielding if practical, as the process volume and access to it are minimized, so that greatly improved monitoring control and safety of the process results. On the other hand, access to the accelerator and conveyors is restricted and product handling flexibility is sacrificed. With a low-maintenance accelerator dedicated to on-line sterilization of a particular range of products, these disadvantages are unimportant in comparison with the advantages of greater compactness, *economy* and *safety* offered by the local shield.

Dose Rate

The choice of the rate at which the sterilizing flux of radiation is delivered to the product has not been a significant factor in the design of conventional radioisotope (Co^{60}) irradiators. Their dose rate range is limited by the specific activity of the isotopes available, and for all practical purposes cannot exceed 1000 rads/second. Typical dose rates offered by available electron beam machinery are illustrated in Figure 5, in which the rate of energy absorption in the product is related to the current density (number of electrons/cm²/second) of the accelerated beam.

For example, the machinery of regime A in Figure 2, the dc Electrocurtain™, typically operates at a current density of 10^{-3} amps/cm² or approximately 10^8 rads/second. Many higher energy machines operate in this regime also, with average rates typically about 10^7 rads/second.

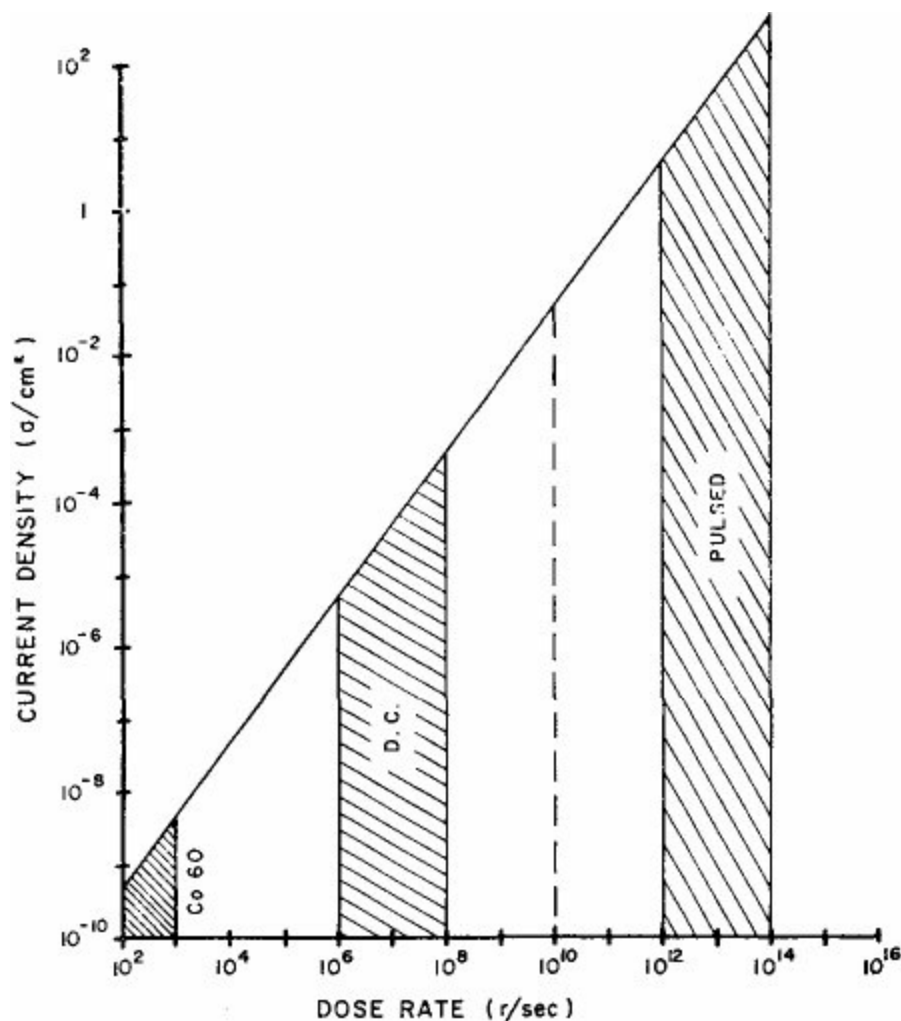

Figure 5. Dose rate vs. electron current density (2 mev.).

This design parameter begins to become important in this range, depending upon the nature of the application. For example, if free-radical initiated polymerization or crosslinking are of concern, a very high dose rate will lead to a low “chemical efficiency” due to radical quenching, thus minimizing changes in product properties. Also, the degradative effects associated with product oxidation are substantially reduced with high rate treatment. Thus, in general the undesirable side effects induced by radiation treatment are greatly reduced at elevated electron dose rates, permitting a wider choice of materials for accelerator sterilized products⁸.

These advantages become even more pronounced at the very high dose rates achieved, as indicated in Figure 5, by pulsed machines... accelerators which deliver relatively high current densities for short periods of time⁹. The engineering of equipment which spans this rate regime, at useful average power levels, is indeed a challenge. The system described in the following section, the double-resonant transformer accelerator¹⁰, provides a good compromise between maximizing average power at elevated dose rates, and minimizing machine size and complexity. These relatively simple high voltage generators/accelerators have been available in various forms for over a decade. Their principles of operation and state of development will now be reviewed within the context of the rate considerations of Figure 5.

The Transformer Accelerator

The voltage generator or power supply used in these accelerators utilizes a transformer to pulse charge one capacitor or energy store, from another. The general schematic is shown in Figure 6. The accelerator tube T and capacitor C_2 form the load to the transformer M, which transforms the energy switched from the primary energy store C_1 .

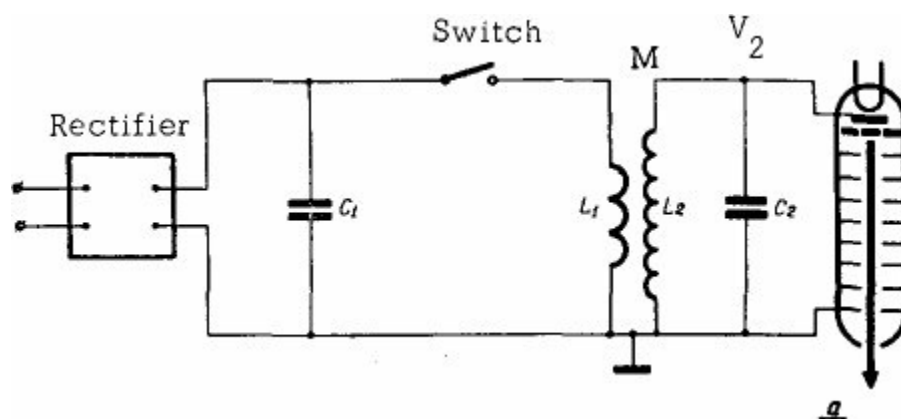

Figure 6. Schematic of transformer driven accelerator.

A detailed analysis of such a circuit¹¹ shows that the inefficiencies normally associated with use of a transformer to pulse charge one capacitor from another, disappear when (see Figure 6),

$$\frac{1}{L_1 C_1} = \frac{1}{L_2 C_2} \quad (1)$$

or, the open circuit resonances of the primary and secondary circuits are identical. Under these conditions, neglecting resistive dissipation in either circuit, there can be total transfer of energy from the primary to the secondary circuits.

Some typical waveforms are shown in Figure 7 for the secondary voltage waveforms under variation of the coupling coefficient (k) of the transformer. This coefficient is a function of the winding geometry and gives a measure of the magnetic coupling of the two circuits. As shown in Figure 7, the value of

$$k = 0.6 \quad (2)$$

is usually chosen since the optimum peak (negative) voltage occurs on the second half cycle of the transient and is typically twice that of the first (positive) transient excursion. Under these conditions (1 and 2), the two normal modes of the circuits have frequencies in the ratio of 2:1, and the term “double resonance principle” has evolved to describe this mode of voltage generator operation.

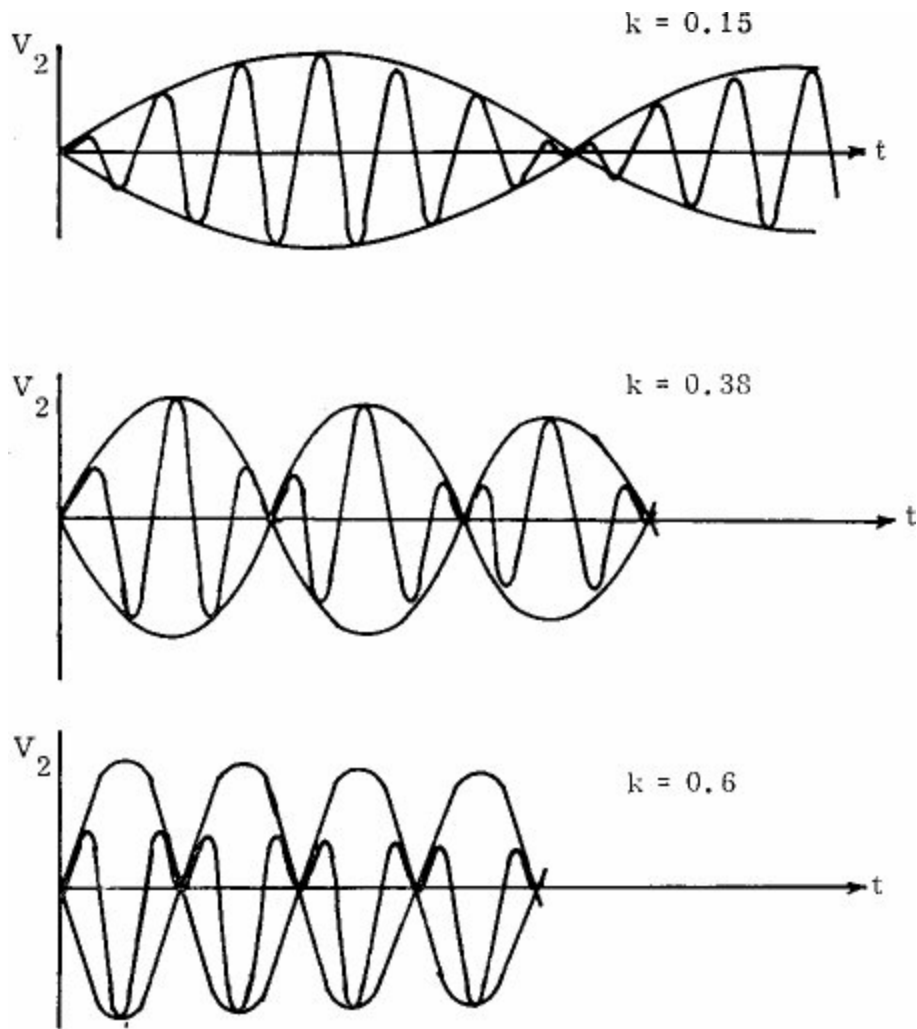

Figure 7. Secondary Voltage for Various Coupling Coefficients.

With such a voltage signature as illustrated in Figure 7 applied to the gun-accelerator structure, the gun is normally biased beyond cut-off until 80-85% of the maximum unloaded peak secondary voltage is achieved. The control grid is then pulsed to a positive value and current accelerated, with pulse widths typically of a few to ten microseconds for circuits whose resonant frequencies are typically in the 50 kHz range. During this loading of the secondary circuit the voltage departs from its sinusoidal waveform so that the emerging electrons can be maintained monoenergetic within limits of $\pm 5\%$. A typical depth-dose profile demonstrating this level of energy control for a transformer accelerator operating at 750 kilovolts, a pulse width of 4 microseconds, a peak current of 15 amperes, and a pulse repetition frequency of 50 pps is shown in Figure 8. The experimental points are shown and give excellent agreement with the profile calculated for a 750 keV beam scattered in the 50μ of Ti (window) and 7 cm of air between the window and sample plane using a Monte-Carlo transport code¹².

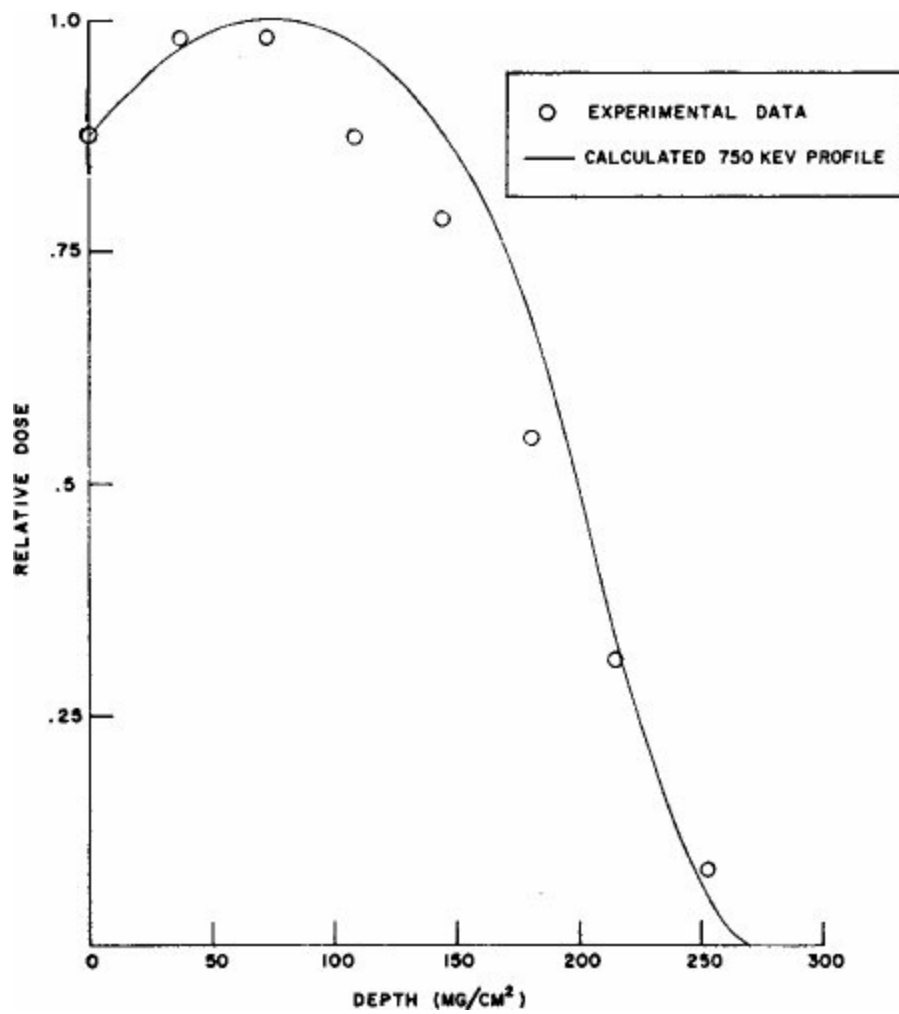

Figure 8. Experimental depth-dose data for the EP 15 transformer accelerator.

The relatively short pulse widths shown in Figure 7, which are characteristic of this type of voltage generator, permit significant economies in insulation design, resulting in decreased machine size. For a given level of voltage performance, the field gradients (gap stresses) used in dc machine design may be greatly exceeded for safe operation in the impulse mode. This is due to the finite time lag required for discharge (or breakdown) initiation and growth.

For example, for short pulses in the microsecond regime, the stress-time relationship in gas dielectrics has the following form¹³:

$$Ft^{1/6} d^{1/10} = \text{constant}$$

where

F is the average field strength (voltage divided by gap spacing) in kV/cm

t is the elapsed time during which the voltage is above 88% of maximum, in microseconds, and

d is the gap in cm

Obviously, the relationship is quite insensitive to gap length and is equally insensitive to electrode area.

Typical values of the constant for SF₆ at 10 atmospheres pressure are in the range of 400. Hence, for a 4 microsecond-pulse typically used, gaps of only 6 cm are required to support a peak or secondary voltage of 1.5 million volts.

The loaded voltage gain for these transformers is in the range of 50-75, so that the drive circuits (Figure 6) used with these machines operate at 10-30 kV. A high power thyratron is used as the

initiating switch. Recuperation techniques are also used which recover and store the energy from the secondary circuit which has not been dissipated or delivered via the electron beam. In this manner, overall energy efficiencies of up to 60% can be realized, depending upon the primary circuit conditions.

Some Typical Designs

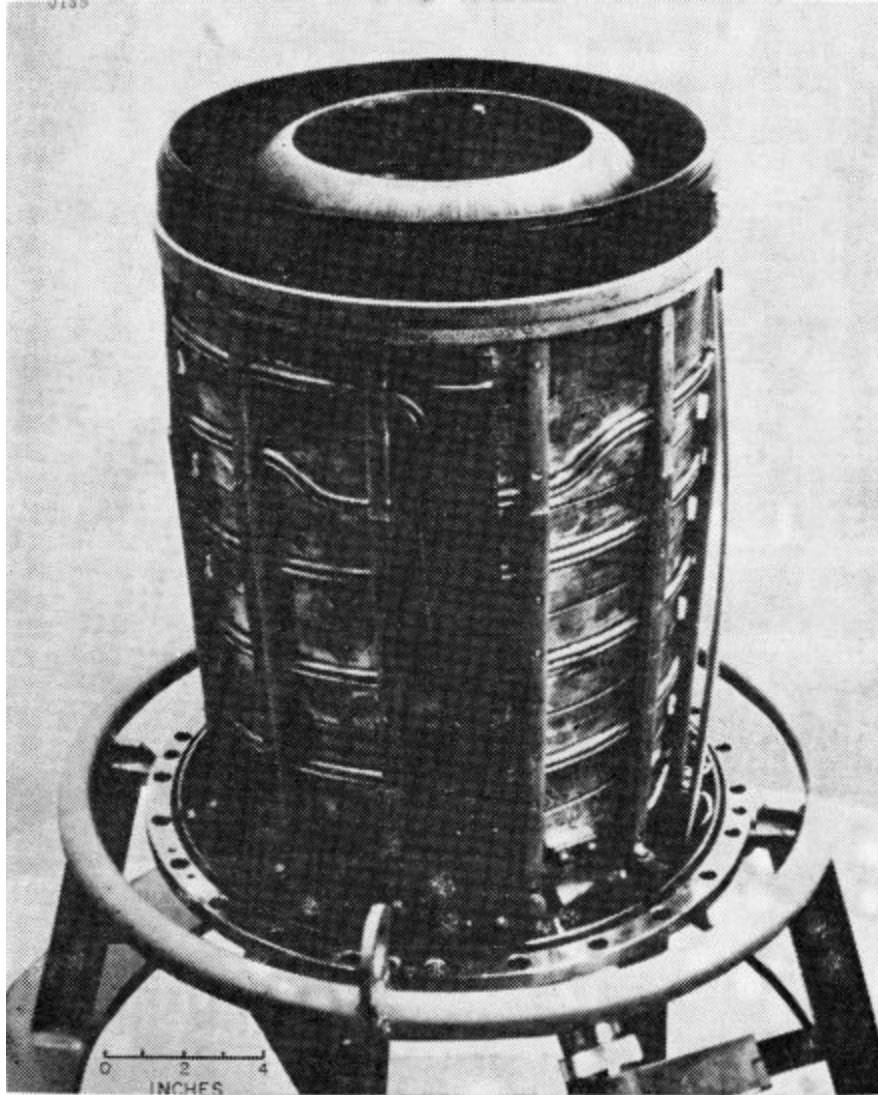

Figure 9(a) Transformer winding geometry.

Because of the high currents flowing in the primary circuit (typically 10 kiloamperes), wide, flat conductors are normally used. Moreover, a spiral winding requires less dielectric volume while providing maximum spacing for insulation of the high voltage terminal while satisfying the required coupling conditions ($k = 0.6$). An example of the transformer for an 800 kilovolt machine developed by the Novosibirsk group is shown in Figure 9(a) with an overall view of this compact 1 kilowatt accelerator shown in Figure 9(b).

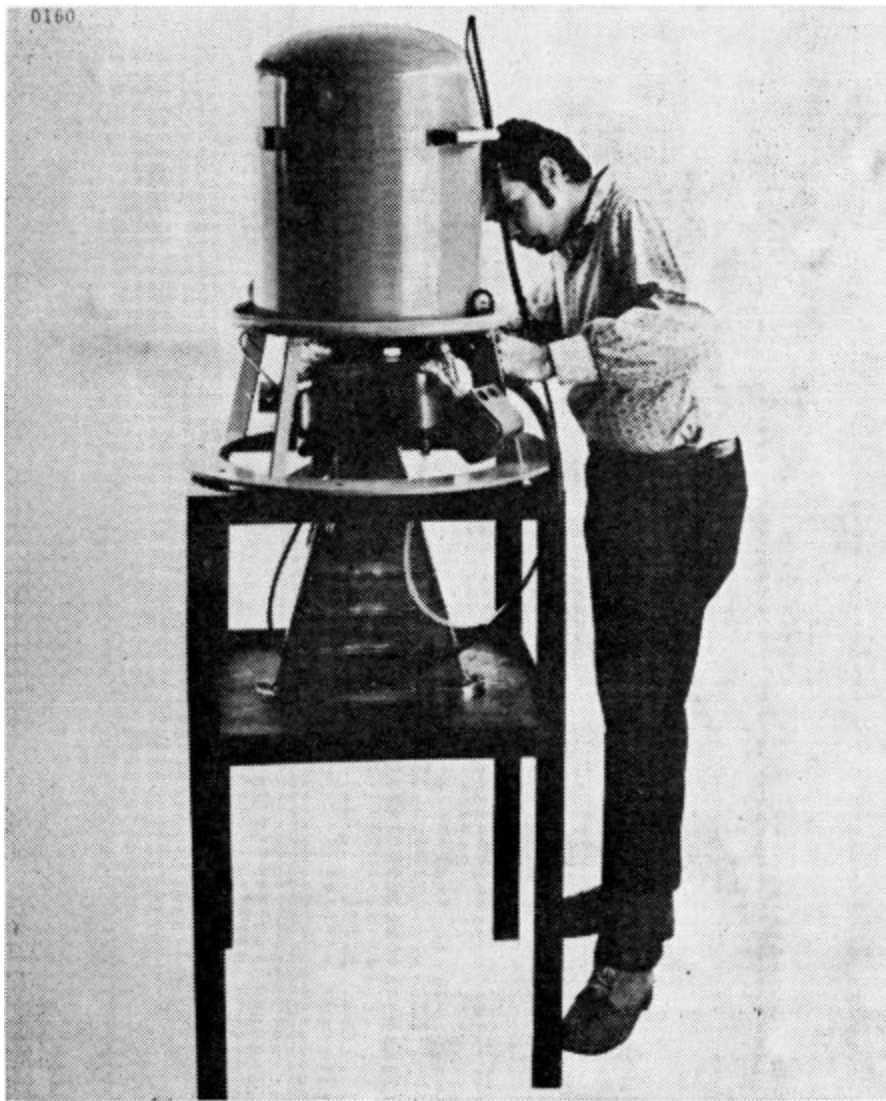

Figure 9(b) The Electropulse™.8, a kilowatt × 800 kilovolt processor.

In these machines the accelerator tube is mounted coaxially with the transformer secondary winding between the high voltage terminal (whose termination is visible in 9(a)) and the ground plane. This compact design provides an excellent voltage distribution along the accelerator tube due to the near-linear voltage distribution of the transformer secondary. As shown in Figure 9(b), the tube pumping in these units is typically handled with an integrally mounted ion pump.

The design of a 1.5 megavolt accelerator designated EP 15 is shown in Figure 10. As shown in the figure, high electric fields are maintained along the acceleration path while shielding the insulating rings of the tube from line of sight interaction with the beam, through the use of dished electrodes.

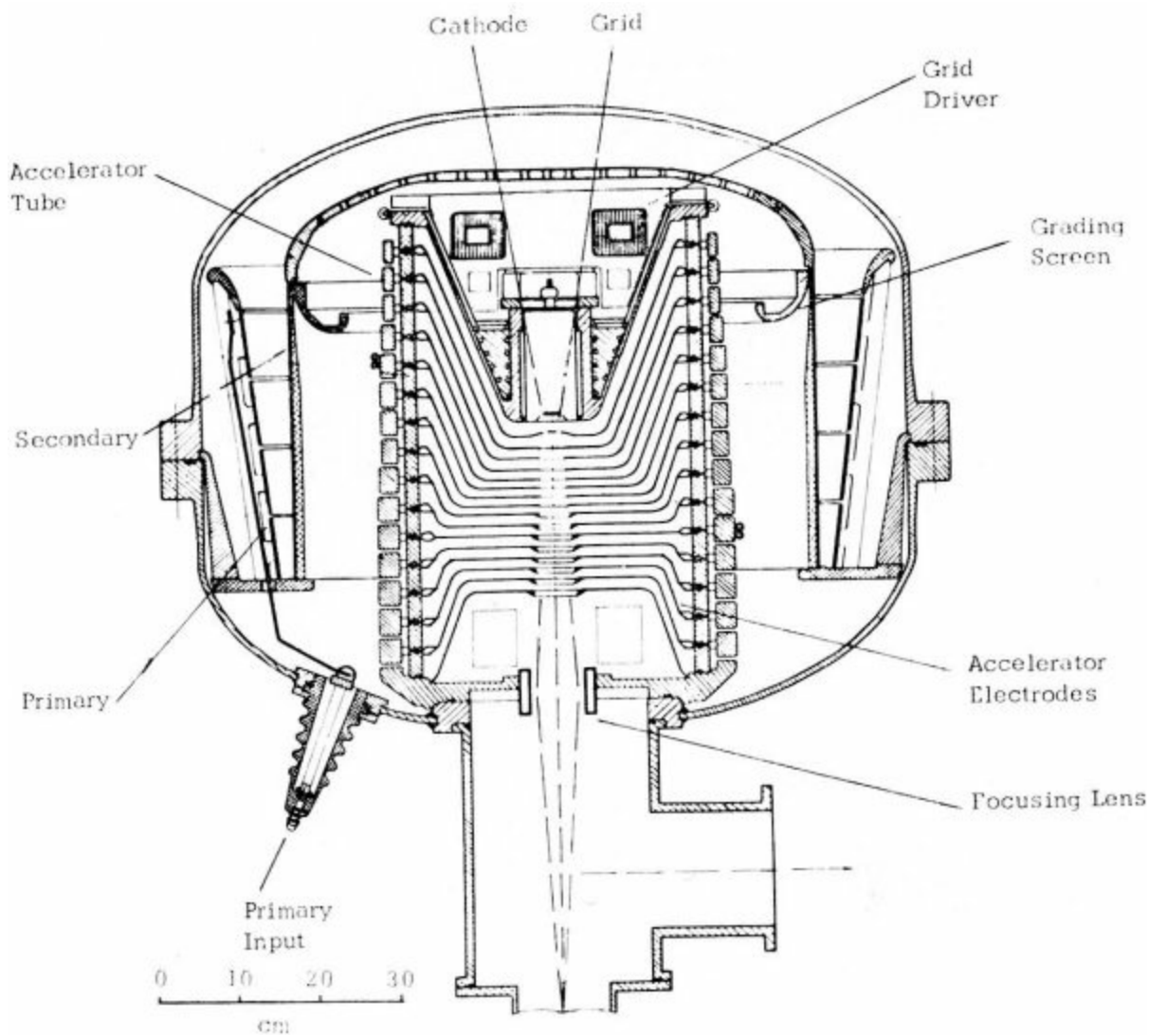

Figure 10. The Electropulse™ 15, a 5 kilowatt × 1500 kilovolt processor.

The external view of this machine is shown in Figure 11. With a vessel diameter of 1.0 meter and a length of 0.8 meter, this compact accelerator will deliver 5 kilowatts at 1.5 MeV. At this level of operation, the accelerator provides 20 ampere pulses (4 amps/cm² or ~ 10¹² rads/second as shown in Figure 5), with a pulse width of 4 microseconds at a pulse repetition frequency of 50 pps.

Other High Dose Rate Machines

As illustrated in Figure 5, the effective instantaneous dose rate from electron sterilizers is limited by the current density available from the gun structure used in the accelerator. These are practically limited to the 1 A/cm² range (10¹² rads/second) for grid controlled systems of the type described in the foregoing section, or of the unscanned transformer excited curtain processors of the configuration shown in Figure 3(b).

Higher current densities and hence delivered dose rates are achievable in accelerators utilizing unconventional cathodes of the “field emission” type⁹. These systems based upon resonant transformer or Marx type supplies, can deliver current densities in the 100 A/cm² range. They utilize a pulse forming network to deliver a well defined voltage pulse to the cold cathode system — now in unmodulated form, and are limited to very narrow pulse-widths (< 100 × 10⁻⁹ seconds). None of these very high performance designs have reached industrial quality but can currently provide reliable,

reproducible sources at these very high dose-rates, at low average power levels.

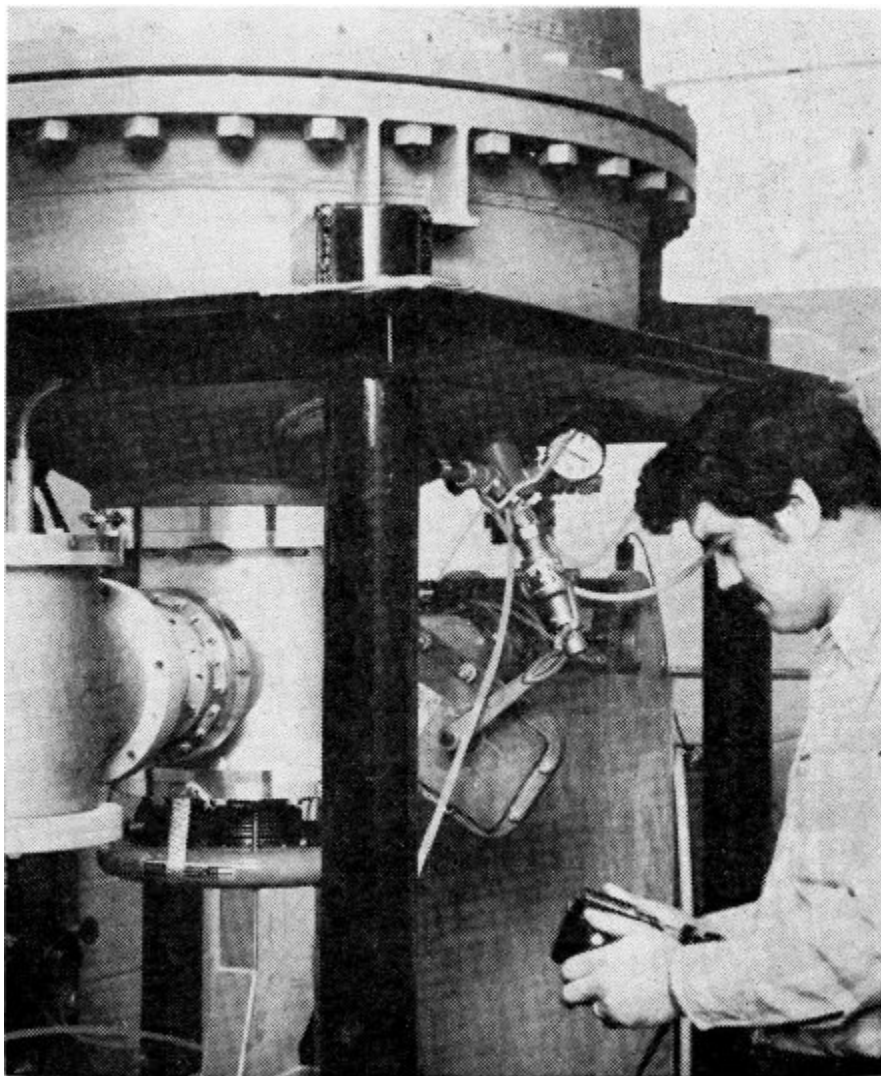

Figure 11. View of high energy accelerator (1.25 MeV) taken during installation.

High Dose Rate Electron Sterilization

Background

There is a well established literature for the ultra-high dose-rate effects with bacteria. The anoxic-like resistance of bacteria irradiated at high rates at low O_2 levels were first demonstrated by Dewey and Boag¹⁴. These results were confirmed and extended by Epp, et al¹⁵ and by Powers, et al¹⁶ and were explained in terms of local oxygen depletion which takes place too rapidly during the irradiation period to permit re-oxygenation via diffusion.

The extension of these ultra-high rate studies, at dose rates of 10^{11} rads/second, to mammalian cells by Berry et al¹⁷, began to suggest a quite different rate dependent mechanism of cell damage. Their interpretation of the reduced efficacy of ultra-high rate radiation was based upon the effects of the high initial radical concentration. It was argued that the radical-radical interactions which occurred would reduce the number available to produce secondary interactions with the biological target in the presence of oxygen. In an anoxic system, where the radicals can decay without cell damage, the effect of initial radical concentration (dose rate) would be expected to be minimal or absent.

There is a more extensive literature on these rate dependent factors determining the “chemical efficiency” or rate constants of ionizing radiation. The early work of Chapiro et al¹⁸, Charlesby et al¹⁹ and others, began to probe the effects of dose-rate on radiation induced polymerization and degradation of polymer-monomer systems, and direct measurements of radical lifetimes were made in these systems. This work proceeded along lines similar to those developed for flash photolysis: if the rate of formation of radicals varies as the radiation intensity, and if the instantaneous radical recombination rate varies quadratically with that radical concentration, one would expect that the radical induced effects for a given dose will be quite different, depending upon whether the radical lifetime is much less than, equal to, or much greater than the exposure time. In other words, radical induced chemical effects in radiation sterilized products will be rate dependent. Since many of the important radical reactions occur in the submicrosecond time regime, there has been good reason to expect a significant change in radical dominated damage mechanisms using radiation sources capable of delivering useful radiation levels in these time periods; i.e. at rates $> 10^{10}$ rads/second²⁰.

In summary then, there has been considerable incentive to probe this high-rate regime in the expectation that for *certain systems*, the bactericidal efficacy of the direct effects of electron (or gamma-ray) irradiation can be utilized while eliminating or minimizing, the deleterious chemical damage associated with indirect (radical induced) phenomena. Recent developments in the machinery of energetic electron generation as outlined in the previous section, have made the dose rate regime up to 10^{14} rads/second (see Figure 5) available with well defined irradiation periods down to the nanosecond (10^{-9} second) time range. Our work in the application of the transformer machines and related pulsed accelerators, has concentrated on these practical aspects of radiation sterilization of commercial products.

In our studies, the comparative lethality of radiation delivered at “high” rates characteristic of Co⁶⁰ facilities (100 rads/second) has been compared, in parallel experiments, with radiation delivered from pulsed electron accelerators in the “ultra-high” rate range from 10^8 - 10^{14} rads/second. A typical set of results for *B. subtilis* spores in nutrient is presented in Figure 12. The systems studied have included aerobic and anaerobic bacteria, virus, molds and enzymes, since the applications of interest embrace both aseptic packaging of materials⁴ as well as surface and bulk treatment of agricultural and medical products. In general, we have concentrated on traditionally “sensitive” products in this work, and some of the results of these rate dependent studies will be reviewed in conclusion.

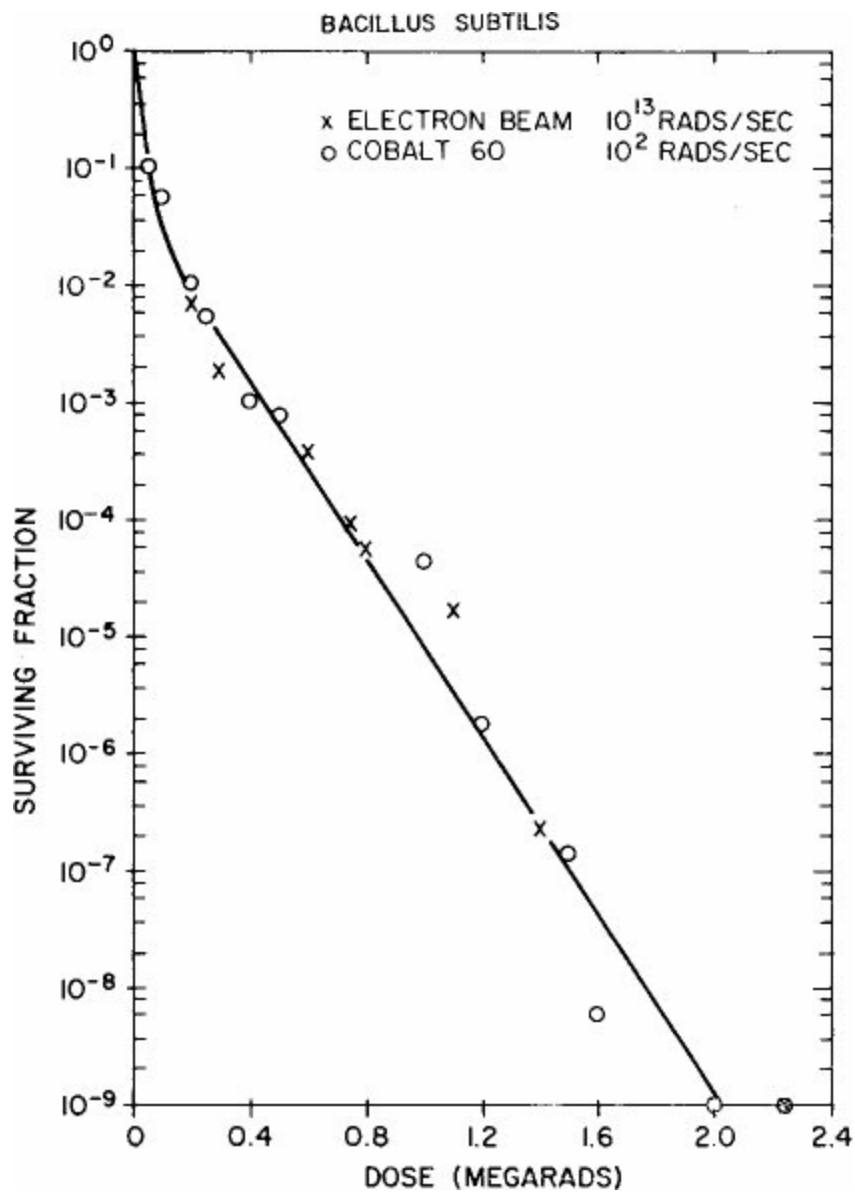

Figure 12. Comparative lethality studies.

Some Rate-Dependent Damage Studies (in Pharmaceuticals)

Some early results on the Co^{60} radiation sterilization of aqueous solutions were reported by Pandula et al²¹. Solutions of atropine (0.1%), morphine (1%) and lidocaine (2%) were studied over the rate regime from $1-10^3$ rads/second at a constant 1 megarad dose: the degradation was found to decrease monotonically with increasing dose rate.

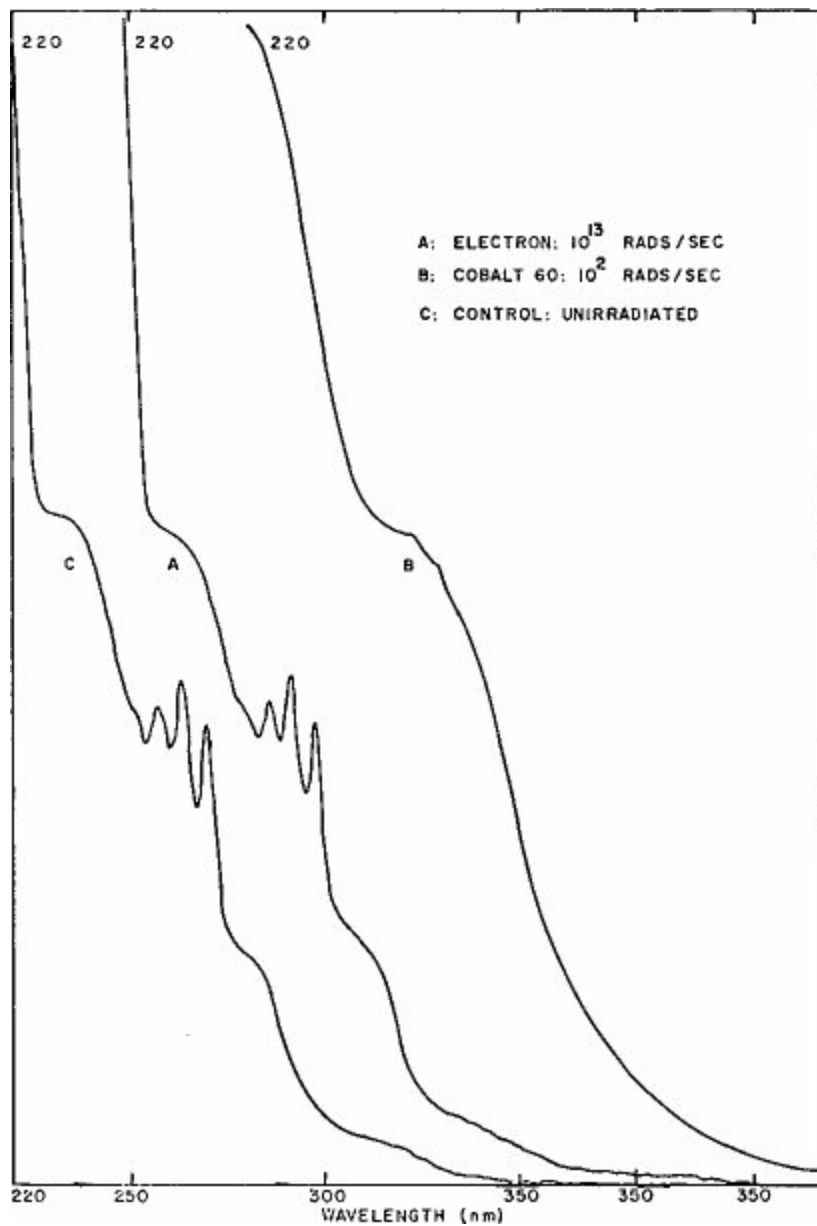

Figure 13. Comparative ultraviolet spectra (alkyldimethylbenzylammonium chloride).

A series of experiments was performed in our laboratory to evaluate the effects of treatment rate on the radiation sterilization of the common disinfectant alkyldimethylbenzalkonium chloride (Zephiran™), at a concentration of 0.3%. In this case, dose rates of 10^{13} rads/second with a pulse duration of 30 nanoseconds (30×10^{-9} seconds) were used in the electron treatment, and compared with samples treated at 10^2 rads/second in a Co^{60} irradiator. Samples were given integrated doses up to 3000 kilorads: calorimetric determinations of dose were used in the accelerator based studies, while Fricke dosimeters were used in determination of the low rate irradiations.

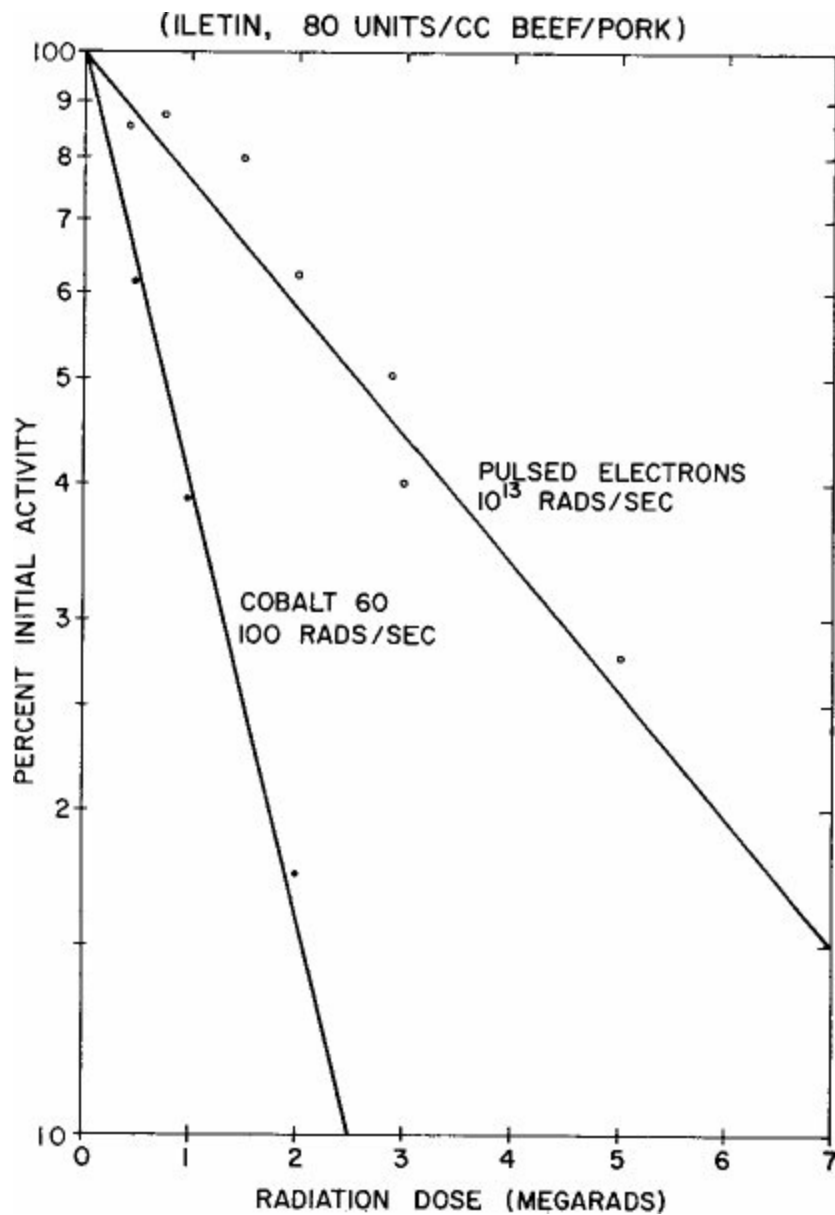

Figure 14. Insulin activity — Radiation induced degradation.

Comparative ultraviolet spectra of two samples irradiated in this manner, and of an unirradiated control, are presented in Figure 13 over the wavelength range from 220-350 nm. It is evident that the structure in the 250-270 nm range has been almost completely destroyed by the Co⁶⁰ irradiation but remains unaffected after the high rate treatment. Although no quantitative degradation measurements will be presented here, zone of inhibition determinations (*S. aureus*) conducted with these samples, treated at high (10^2 rads/second) and ultrahigh (10^{13} rads/second) dose rates, revealed near complete degradation of the sample subjected to the former treatment, with no alteration of biocidal efficacy in the case of the latter. In this and similar quaternary compounds, damage undoubtedly occurs from the radical induced destruction of the alkyl group bonds in these cationic amine compounds. Figure 13 demonstrates the effects of rate on this mechanism.

A similar experiment using a protein based parenteral (beef/pork insulin — 80 units/ml) is illustrated in Figure 14. The conditions of irradiation were identical to those already discussed — since the electron irradiation period was held constant in all cases (30 nanoseconds), the rates varied from 10^{13} - 10^{14} rads/second (750 kilorads — 4 megarads) for the treatment range selected. After room temperature irradiation, the samples were diluted to a concentration of 1 μ unit/ml and a

radioimmunochemical assay performed using the method of Hales and Randle²². Other assays directed at determination of associated chemical degradation of the insulin were not performed. The data of Figure 14 once again illustrate the greatly reduced degradation of the insulin activity at all levels for the ultra-high rate treatment due to the high radical recombination characterizing this regime.

Conclusions

Developments in the technology of high dose rate (pulsed) energetic electron machinery over the past five years have greatly improved the reliability, flexibility and compactness of equipment suitable for on-line industrial sterilization application. The resonant transformer accelerators represent a good compromise of power, energy and dose rate for a broad range of these primary process parameters. At the present, the advantages of high rate sterilization are incompletely understood, with perhaps the exception of the simplest polymer systems. Greater effort should be expended in the evaluation of this process, now practical on a commercial scale at rates above 10^{10} rads/second, with particular emphasis on thermal labile and (Co^{60}) "radiation" labile products.

Acknowledgements

The author has appreciated the assistance of R. N. Cheever in the preparation of this manuscript. The work of G. Simcox (ESI) and the cooperation of the Institute of Nuclear Physics at Novosibirsk under the direction of G. Budker has been essential to our improved understanding of this technology. The continued assistance of both the National Marine Fisheries Laboratory at Gloucester, Massachusetts, and of the Enzyme Laboratory at Tufts University in the pursuit of these studies, is gratefully acknowledged.

References

1. *Large Radiation Sources for Industrial Processes*, Proc. IAEA Symposium, Munich, August 1969; STI/PUB/236, IAEA, Vienna, 1969.
2. Brasch, A. A. *Anschluss therapie* **4**, 505, (1932); U.S. Patent Nos. 2,429,217 (May 1942) and 2,456,909 (Sept. 1946).
3. Spencer, L. V. *Energy Dissipation by Fast Electrons*, National Bureau of Standards Monograph 1, U.S. Gov't. Printing Office, Washington, D.C., Sept. 1959.
4. Hipple, J. and Nablo, S. V. "Low Energy Electron Beams for Surface Sterilization and Aseptic Practice", Proc. Thirteenth ANTEC Conf., Part 2, 824, Soc. Plastics Eng., Inc., Greenwich, Conn. (1972); U.S. Patent 3,780,308, Dec. 18, 1973.
5. Simon, D. J. and Michelier, R., "Experiments in an Electrostatic Separator with Multiple Plates", Proc. Third Symposium on Discharges and Electrical Insulation in Vacuum, Paris (1968).
6. Mulcahy, M. J. *et al.* "Breakdown and Flashover in Electronegative Gas Mixtures — Insulator Evaluation, Time Lag and Impulse Ratio Measurements", Proc. Elect. Ins. Conf. 300, Sept. (1971).
7. *Occupational Safety and Health Act of 1970*. Paragraph 1910.96, 22158-22159, Federal Register, Vol **37**, #202, October (1972).
8. Hansen, P. "Radiation Treatment of Meat Products and Animal By-Products", *Food Irradiation*, 411, Proc. Karlsruhe Conf., June 1966; STI/PUB/127, IAEA, Vienna, 1966.
9. Graybill, S. and Nablo, S. V., "The generation and Diagnosis of Pulsed Relativistic Electron Beams Above 10^{10} Watts", IEEE Trans. Nuc. Sci. NS-14. #3, 782 (1967).
10. Abramyan, E. A. *High Current Transformer Accelerators*, Institute of Nuclear Physics, Novosibirsk (1970).
11. Finkelstein, D., Goldberg, P. and Shuchatowitz, J., "High Voltage Impulse System", Rev. Sci. Inst. **37**, 159, (1966).
12. Berger, M. J. *Methods in Computational Physics*; Vol. **1**, 135, Academic Press, Inc., N.Y. (1963).
13. Denholm, A. S. *Review of Dielectrics and Switching*, Section 4, AFWL-TR-72-88, AFWL, Albuquerque, N.M., February (1973).
14. Dewey, D. L. and Boag, J. W. *Nature* **183**, 1450, (1959).
15. Epp, E. R., Weiss, H. and Fenlon, A. *Radiation Research* **31**, 646, (1967).
16. Tallentire, A. and Powers, E. L. "Modification of Sensitivity to X-Irradiation by Water in *Bacillus magaterium*", Rad. Res. **20**, 270,

(1963).

17. Berry, R. J., *et al.* "Survival of Mammalian Cells Exposed to X-Rays at Ultra-High Dose Rates", *Br. J. Radiol.* **42**, 107, (1969).
18. Chapiro, A. *Radiation Chemistry of Polymeric Systems*, Interscience Publishers, New York (1962).
19. Charlesby, A. *Atomic Radiation and Polymers*, Pergamon Press, London (1960).
20. Schwarz, H. A. "Intensity Effects, Pulsed-Beam Effects and the Current Status of Diffusion Kinetics", *Rad. Res. Supp.* **4**, 89 (1964).
21. Pandula, E. L., Farkas, E. and Pacq, I. "Effects of Radiosterilization of Sealed Aqueous Solutions", *Proc. Symp. Radioster. Med. Prod.* **83**, STI/PUB/157, IAEA, Vienna (1967).
22. Hales, C. N. and Randle, P. J. "Immunoassay of Insulin with Insulin-Antibody Precipitate", *Biochem. J.* **88**, 137 (1963).

Advances in Electron Beam Linear Accelerator Technology

J. Haimson

Haimson Research Corporation, Burlington, Massachusetts, USA.

An introductory section describes how the microwave electron linear accelerator differs fundamentally from other forms of particle accelerators. A brief review of the early history and development of linear accelerators indicates that progress in this field was severely curtailed until, as a direct result of World War II radar development, suitable high power RF tubes became available. Progress in linear accelerator technology since then has been rapid and extensive, with more than 600 machines being placed into service in a wide variety of research, medical and commercial applications.

The simplified theory and operational characteristics of linear accelerators are presented; and it is shown that RF to electron beam power conversion efficiencies of 85 to 90% are attainable with microwave accelerating structures. Typical

Abstract: *performance figures in the range of 3 to 7 MeV with beam power levels up to 36 kW are listed.*

Twenty year trend curves and component lifetime data reveal that technological advances have resulted in a dramatic improvement in the reliability of high power linear accelerators. An outstanding advantage, unique to the microwave linear accelerator, is that the high voltage accelerating column is a short, all-metal waveguide structure. These structures, together with advanced design, all-brazed, metal and ceramic electron gun assemblies, which are highly resistant to radiation damage, are illustrated and discussed in some detail.

Limitations and advantages of the linear accelerator are discussed in a concluding section; and the concept of an economic, high power, future machine using cw RF power and beam recirculation is presented in an Appendix.

Introduction

The purpose of a linear accelerator (similar to that of other types of accelerators) is to cause a charged particle beam of low initial energy, usually in the kilovolt range, to be accelerated rapidly to energy levels in the megavolt or gigavolt range. The microwave linear accelerator differs fundamentally, however, from other accelerator types in that,

- (a) The accelerating tube is an all metal structure, the entire outside surface of which remains at dc ground potential.
- (b) Electromagnetic energy is transferred directly to the electron beam from microwave fields which are maintained in the accelerating tube.
- (c) The beam energy gain per unit length of the accelerating structure can be very high, depending on the microwave input power level. For example, in the majority of commercial applications, linear accelerators operate routinely with gradients in the range of 60 to 120 kilovolts per centimeter, i.e., 6 to 12 MeV per meter length of accelerating tube; whereas in laboratory machines, typical operating gradients are in the range of 10 to 20 MeV per meter.
- (d) The system operates normally in the pulsed regime, thus enabling a given integrated dose to be delivered with extremely high instantaneous levels of radiation intensity.

The microwave linear accelerator has two basic forms, the travelling wave type in which the radio-frequency (RF) fields are arranged to propagate along the entire structure so that energy is transferred

continuously to the beam, and the standing wave type which comprises a series of individual microwave cavities specifically phased and positioned along the flight path of the beam so that the electrons gain energy by successive discrete interactions with the RF accelerating fields in the cavities.

Although the concept of accelerating charged particles by repetitive impulses of energy appears to have been proposed initially in 1924¹, and the first successful experiments were conducted in the late 1920's and early 1930's^{2,3,4}, progress in this field was severely curtailed by the lack of suitable high power RF generators.

With the successful operation of the klystron RF amplifier⁵, and, in particular, because of the availability of high power magnetron RF oscillators and associated microwave devices, which were developed during World War II for high power radar applications, the immediate post war years saw the first successful operation of microwave linear accelerators^{6,7,8}. These early machines produced pulsed electron beams of low duty factor at megavolt energies by using multi-megawatt peak power RF generators which operated at a frequency of approximately 3000 MHz (S-band). Progress in linear accelerator technology since then has been rapid and extensive with the installation worldwide of more than 600 machines in a wide variety of applications including high, medium, and low energy nuclear physics research, megavoltage radiotherapy, industrial radiography, radiochemistry, industrial processing, sterilization of medical supplies, the study of intense radiation effects, etc.

Principle of Operation

The basic objective of all forms of linear accelerators is to establish suitably phased components of electric field along the beam centerline in such a manner that the electron energy steadily increases. A cylindrically shaped microwave cavity excited in the TM_{010} mode^{9,10} is ideally suited for this purpose. This fundamental mode exhibits a longitudinal electric E field, having a maximum intensity in the axial region of the cavity, and an azimuthal H field as illustrated in Figure 1(a). These spatially orthogonal fields reverse direction each half cycle, oscillating in time quadrature and with a sinusoidal amplitude dependency. Thus, at that instant in time when the longitudinal E field has built up to its peak intensity, the H field has reduced to zero, and vice versa.

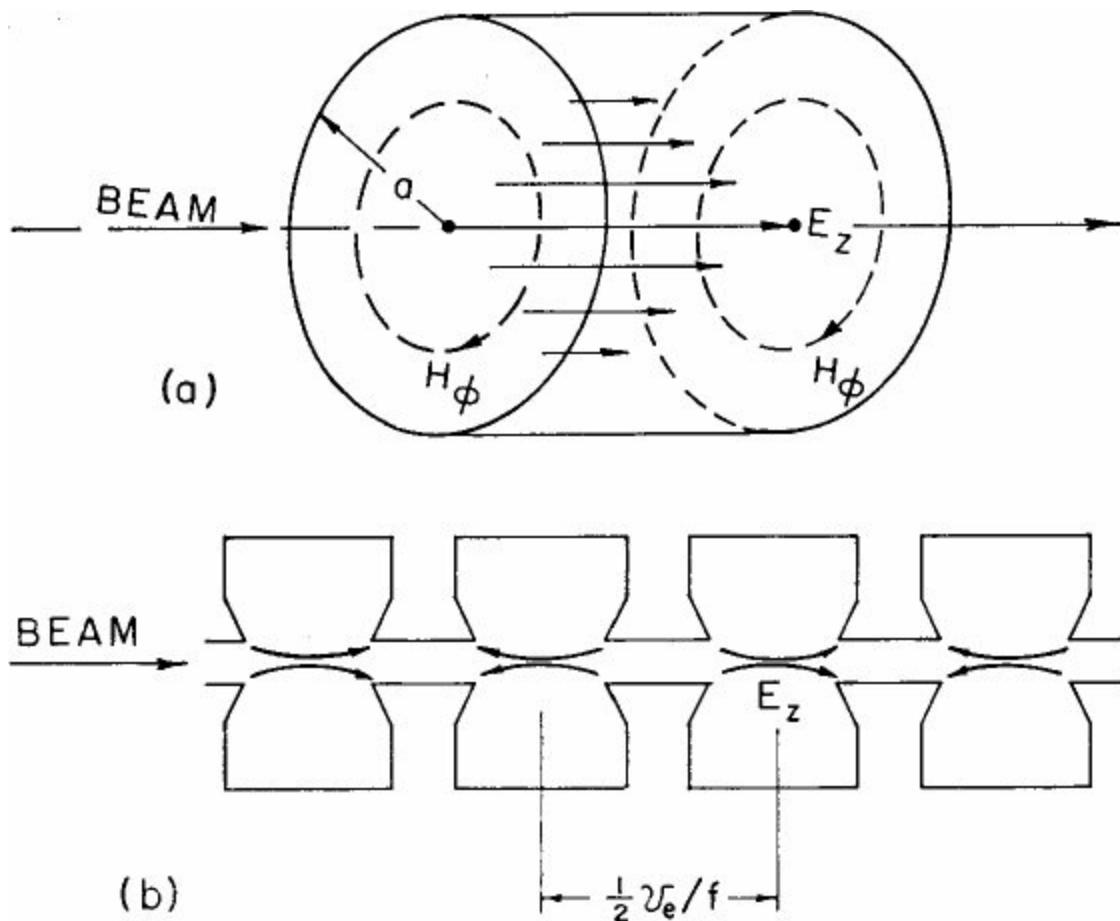

Figure 1. (a) Circular Cylindrical Cavity — TM_{010} Mode.

(b) Array of Standing Wave TM_{010} Cavities.

In the case of the standing wave linear accelerator, we can consider an axially aligned array of microwave cavities oscillating at the same frequency and in the TM_{010} mode, but with a 180° phase shift between neighboring cavities, as illustrated in Figure 1(b).

By injecting a relatively low-energy electron beam into the first cavity at a time when the longitudinal electric field is beginning to build up in the direction to cause acceleration, and by arranging the separation between successive cavities to equal the distance travelled by the electron during a half cycle of the microwave frequency, it is clear, that the electron beam energy will increase incrementally through each successive cavity.

For both the standing wave and the travelling wave accelerator, the gain in energy (V) of the electron is explicitly defined by the phase and amplitude of the E field along the centerline of the structure, i. e., $V = \int_0^L E(z, t) dz$; and for a given geometry, the field strength is dependent only on the level of RF power dissipated in the walls of the structure and the quality factor Q . (Q is defined as the ratio of the energy stored in the electromagnetic fields to the energy dissipated per radian of the RF cycle.)

In the travelling wave linear accelerator, an electromagnetic field pattern having a longitudinal electric field vector is arranged to propagate through a circular cross-section waveguide (accelerator tube) in synchronism with the electron beam and at a specific phase relationship which ensures that energy is transferred continuously from the RF fields to the beam.

As an illustration, Figure 2(a) shows the TM_{01} mode pattern of a sinusoidal E field wave travelling through a circular waveguide of uniform cross-section. In this simple configuration, the uniform

waveguide cannot be employed for particle acceleration because the phase velocity of the travelling E field is always greater than the velocity of light. In practice, this problem is avoided by periodically loading the waveguide with a series of annular shaped discs. RF power coupled into a loaded waveguide of this description can be conveyed along the structure in a variety of modes; and, by suitably shaping and locating the annular discs, the amplitude and velocity of the longitudinal E field can be very accurately controlled.

Figure 2(b) shows the instantaneous travelling wave electric field pattern for a three disc per wavelength loading of an accelerator waveguide, i.e., a 120° phase shift per cavity — a design which is commonly used in present day linear accelerators.

One form of waveguide design arranges for the RF phase velocity in the initial portion of the waveguide to match the velocity of electrons which are injected into the structure from a relatively low potential electron gun. Through an initial sorting and then bunching process, electrons become trapped by the electric fields and bound to the RF wave, the velocity of which is then arranged to increase up to the velocity of light, thereby rapidly accelerating these bound electrons to relativistic energies. At this stage (several MeV), the electron beam is considered “stiff”, and to ensure synchronization, the RF phase velocity is maintained at the speed of light throughout the remainder of the waveguide. The electrons continue to gain energy from the RF wave, and this is manifest largely by a continual increase in mass rather than velocity. The first portion of such an accelerator waveguide is referred to as the buncher section.

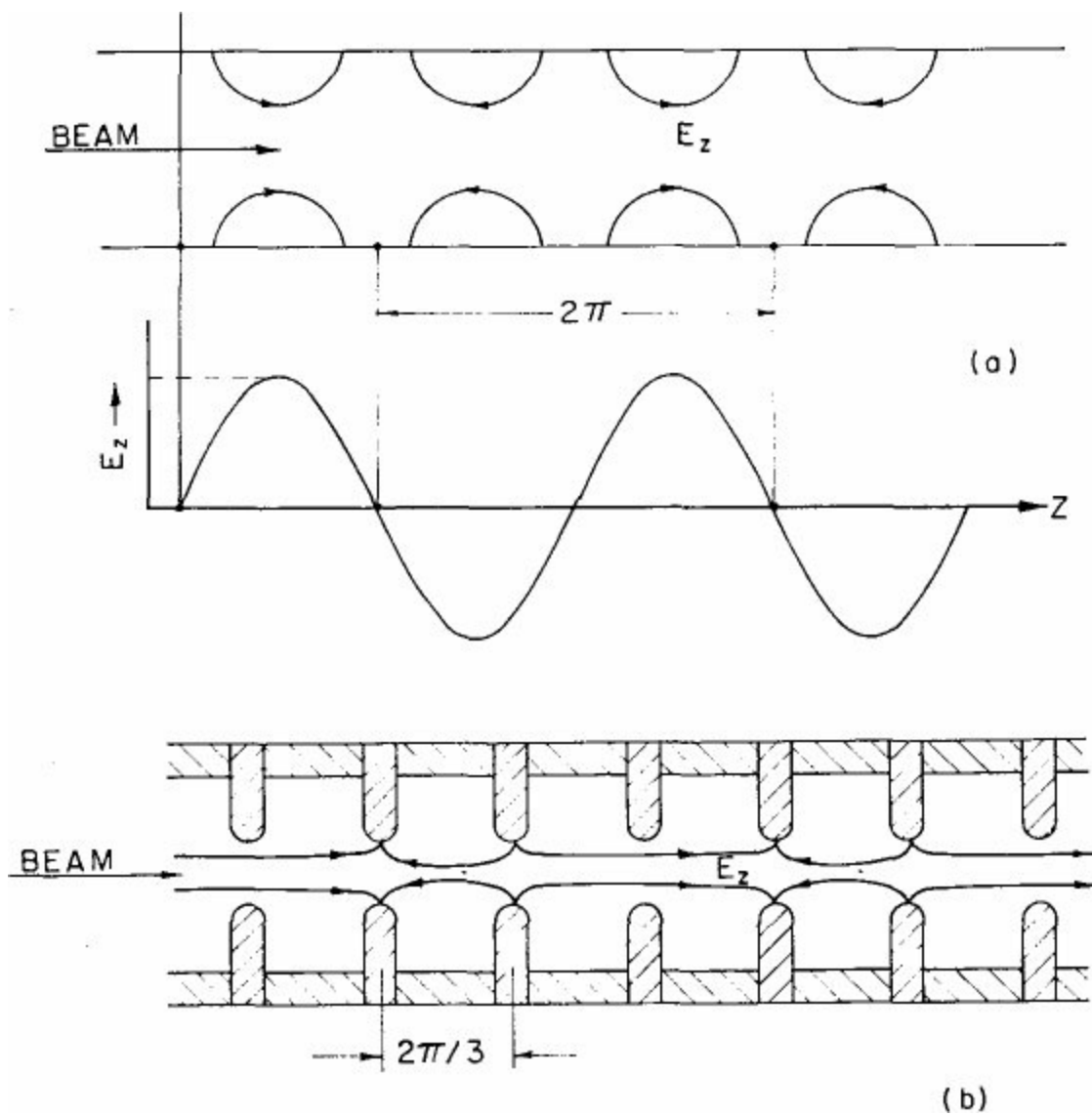

Figure 2. (a) TM_{01} Unloading Cylindrical Waveguide Mode Pattern and Travelling Wave Longitudinal Electric Field Amplitude.
 (b) Instantaneous Travelling Wave Electric Field Pattern in a Loaded Waveguide Having a Phase Shift per Cavity of $2\pi/3$.

For a given buncher configuration, there is a definite time interval with respect to each successive cycle of the RF wave in which the injected electrons will be trapped and accelerated to some asymptotic phase stable position upon the travelling wave. Electrons which are injected early in phase, or electrons which are too energetic or have “over-oscillated”, will be in too forward a position on the wave, and they will enter an environment of decreasing acceleration the further they advance. These electrons will slow down and fall back with respect to the wave. Similarly, electrons that have slipped back with respect to the synchronous phase, will experience increasing electric fields; and these electrons will move forward upon the wave. This process tends to trap and then bunch the electrons at a particular phase stable position upon the RF wave¹¹.

Another form of travelling wave accelerator dispenses with the variable phase velocity buncher and utilizes, throughout the entire length of the structure, a uniform phase velocity equal to the velocity of light. In such a system, relatively high electric field strengths and/or injection potentials are required in order that electrons, which are injected into the guide during the acceptance phase interval of each RF cycle, will become trapped, bunched, and ultimately located at the crest of the RF wave.

To obtain the highest possible energy gain with a given length of accelerator waveguide and to achieve a sharp energy spectrum, it is necessary to produce narrow bunches of electrons which are

located at the crest of the travelling RF wave in the shortest possible distance after injection, and which are then maintained synchronously at this position throughout the length of the accelerator waveguide. Thus, considerable improvement in accelerator performance may be gained by chopping and/or prebunching the electron beam prior to injection into the accelerator waveguide.

A sectioned portion of a typical S-band high gradient travelling wave accelerator tube and an array of S-band standing wave cavities are shown in Figure 3. Waveguide structures of this type are constructed with high conductivity copper components which are brazed together in a high temperature furnace to form integral assemblies that seldom require replacement or maintenance.

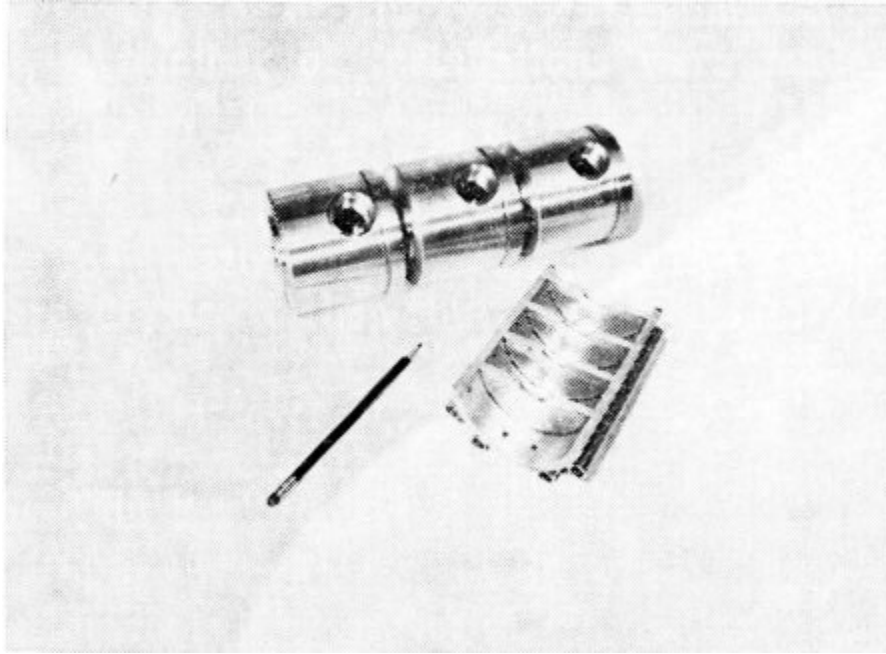

Figure 3. Sectioned View of an S-Band Travelling Wave Accelerator Tube and an Array of S-Band Standing Wave Cavities.

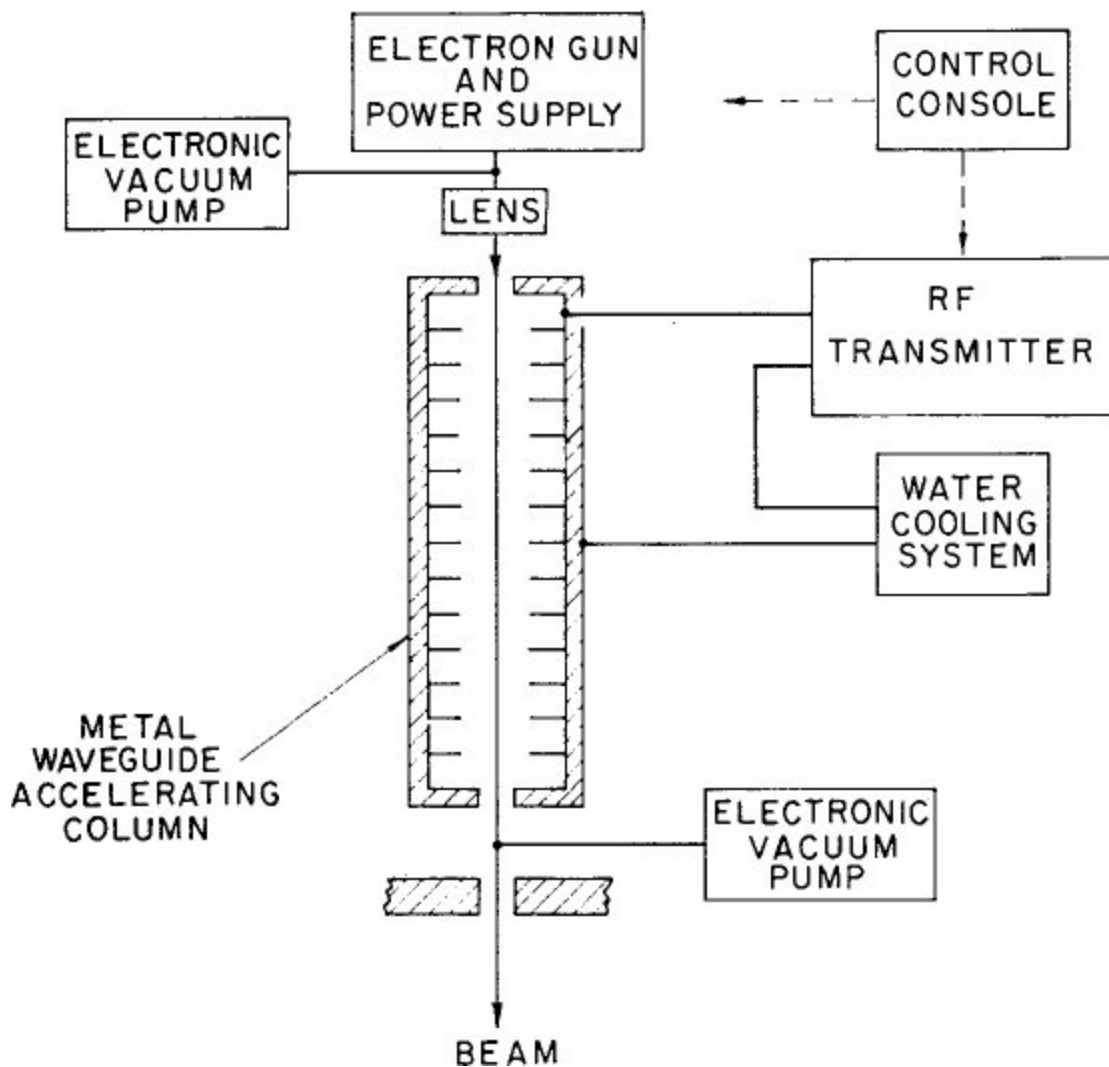

Figure 4. Block Diagram of a Typical Linear Accelerator System.

Description of Overall System

In addition to a low energy injected electron beam and a source of input RF power, and in common with other particle accelerators, the linear accelerator requires vacuum pumping, water cooling, and a control and safety interlock system. The major components of a typical linear accelerator system are identified in the Figure 4 block diagram.

Pulsed operation of the accelerator, using established techniques and equipment not unlike those developed for radar applications, allows RF peak power levels in the megawatt range to be obtained from relatively small components. Typically, the transmitter provides pulsed RF power to the accelerator waveguide at a specific duty factor with pulse lengths of several microseconds duration and at repetition rates of several hundred pulses per second. (The term “duty factor” as related to the electron beam, is the ratio of average to peak current. Thus, an accelerator having a beam duty factor of, say, 1%, e.g., 20 microsecond pulse length and 500 pulses per second, would deliver an average current of 5 mA when operating at a peak current of 500 mA.)

In general, the transmitter’s RF output tube, which is typically either a klystron or a magnetron, is connected directly to the accelerator tube by a short section of rectangular waveguide which operates in the TE_{01} mode. This mode is transformed automatically to the desired TM_{01} mode, and the RF wave is

launched along the accelerator tube, by an RF input coupler which is an integral part of the all-metal waveguide structure.

The electron gun and the accelerator waveguide form a contiguous chamber which, in modern machines, is pumped electronically with sputter-ion vacuum pumps. Thus, the vacuum system is free of organic materials and can, if desired, be “baked-out” to provide an ultra-high vacuum condition. Depending on the choice of design, the electron gun may be either pulsed as a diode at the full operating potential, or maintained at a constant negative dc potential and operated as a triode by applying low voltage pulses to a beam extraction electrode.

After acceleration, the high energy electron beam may be either focused onto a water-cooled target to produce X-rays, or extracted through a thin metal window and applied directly to the product.

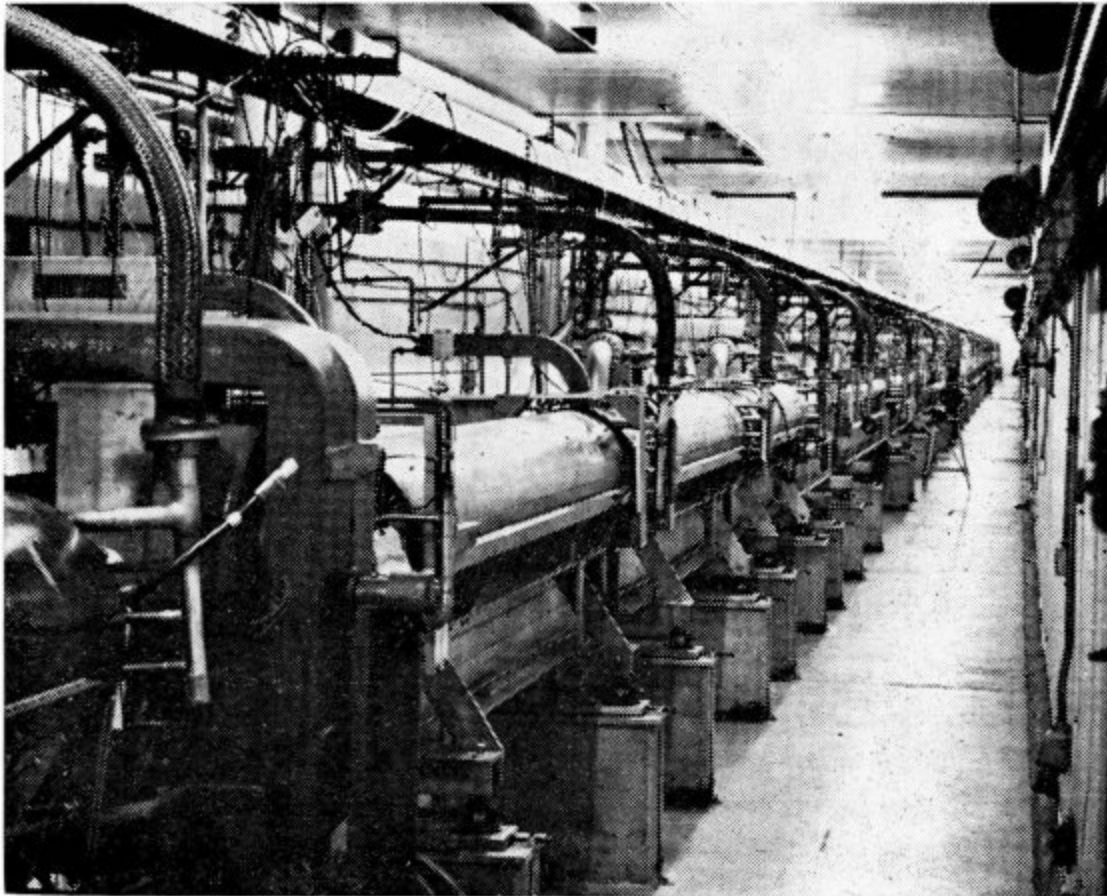

Figure 5. Beam Centerline View of the 400MeV High Duty Factor Electron Linear Accelerator at the Massachusetts Institute of Technology.

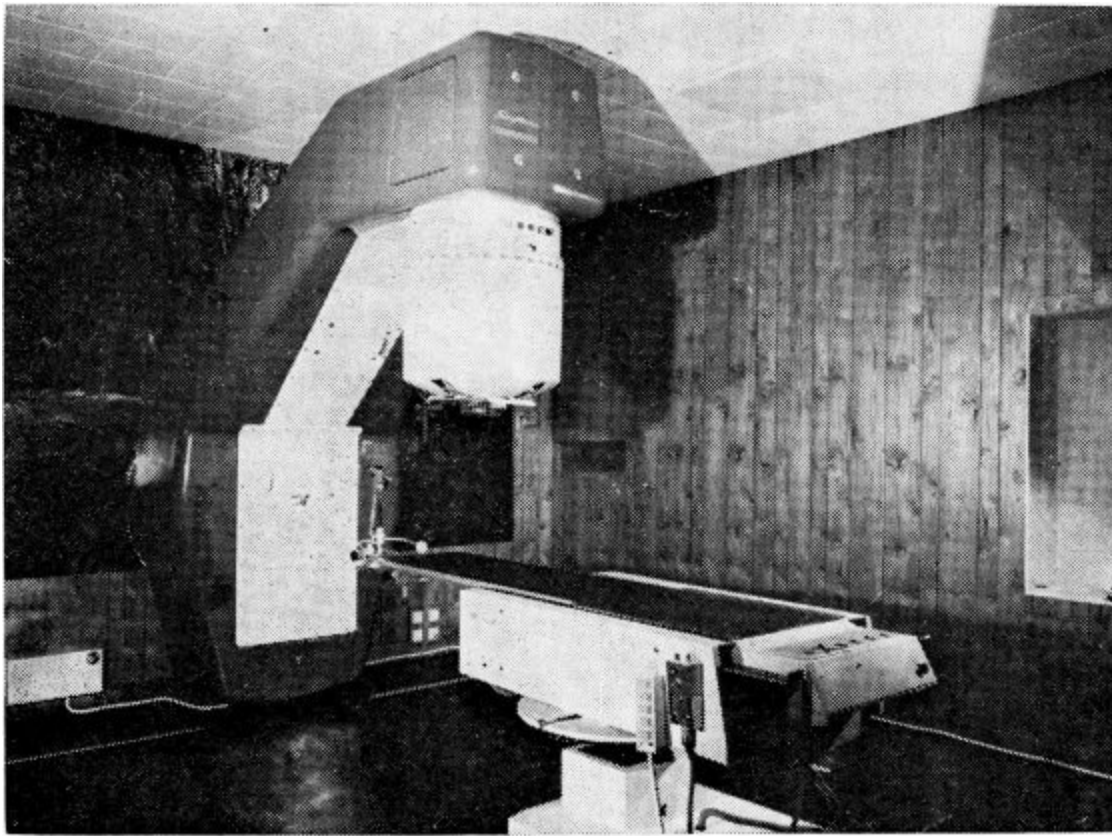

Figure 6. A 7 to 40 MeV Radiotherapy Linear Accelerator Constructed by Thomson-CSF.

Typical Linear Accelerator Applications

Because of the wide range of electron beam applications and the large number of linear accelerator facilities in operation, it is not possible in this short paper to present a fully representative picture of the various manufacturers' machines, or even those specialized linear accelerators which have been built and recently brought into operation by "in-house" activities within government funded institutions.

Linear accelerators range from compact, low energy radiotherapy units to large high power nuclear physics research machines which employ very sophisticated beam optic techniques to achieve extreme stability, resolution, and reproducibility of the output beam. As an example of this latter class of machine, Figure 5 shows a beam centerline view of the 400 MeV high duty factor machine recently commissioned at the Massachusetts Institute of Technology. This S-band travelling wave linear accelerator incorporates a 7 MeV buncher waveguide followed by a series of 15 MeV and 21 MeV accelerating structures.

Figures 6, 7 and 8 illustrate typical radiotherapy linear accelerator installations. Figure 6 shows a Thomson-CSF machine which is rated at 7 to 40 MeV for electron therapy and 10 to 25 MeV for photon therapy; Figure 7 illustrates a Varian Associates 18 MeV accelerator, shown positioned under the patient support assembly to provide an upward directed beam; and Figure 8 shows an ARCO 6 MeV installation. Radiotherapy linear accelerators of the above type are, in general, designed for dual modality applications (treatments using both electron and X-ray beams), and may be maneuvered around the patient to satisfy the requirements of multiple port therapy.

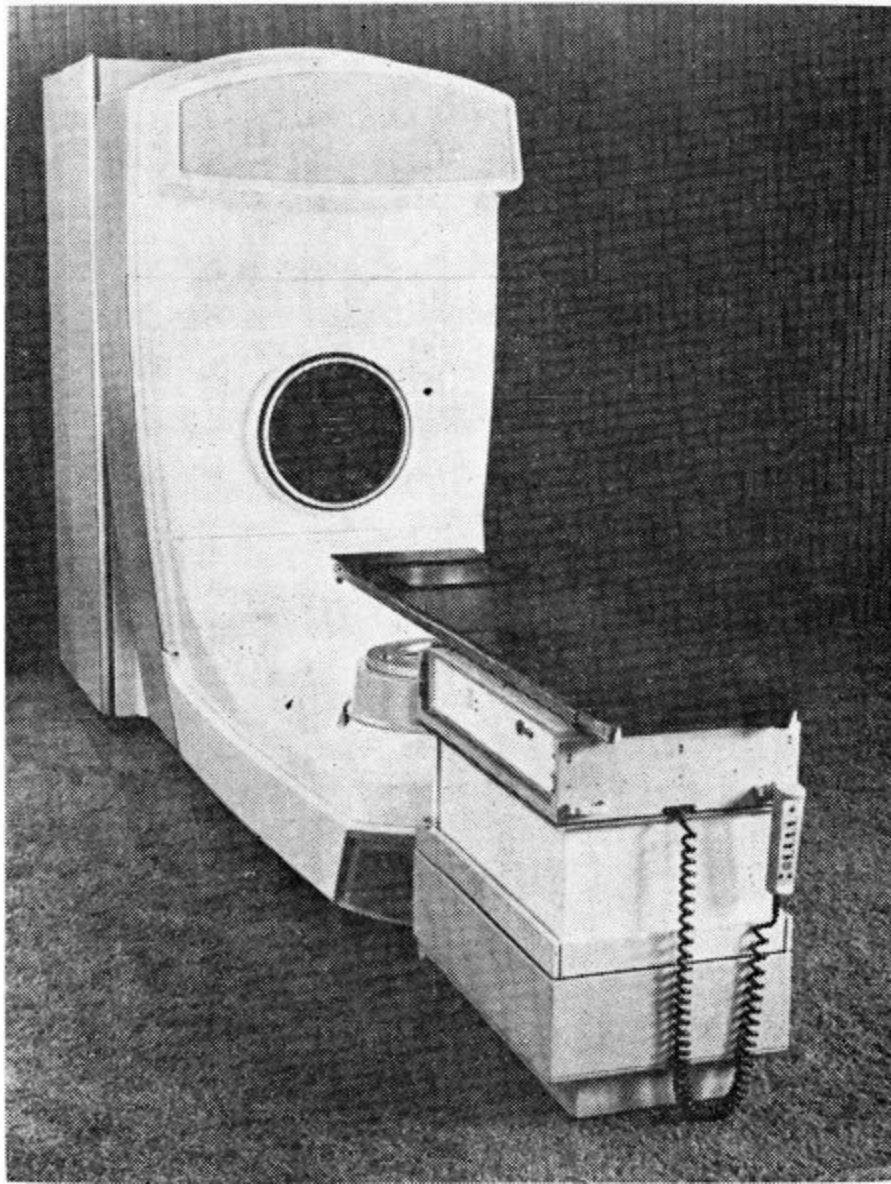

Figure 7. A Varian Associates 18 MeV Radiotherapy Linear Accelerator Shown Rotated Beneath the Patient Support Assembly to Provide an Upward Directed Beam.

Figure 9 shows a bridge crane mounted linear accelerator being used for the radiographic inspection of a large turbine housing. This Thomson-CSF 6 MeV machine is energized by a 2 MW peak, 2 kW average RF power S-band magnetron.

A view of the 5 to 30 MeV linear accelerator at the US army Natick Laboratories is shown in Figure 10. This radiation processing machine, one of the earliest high power accelerators, has been operating for over 12 years in a variety of applications associated with the radiation preservation of food. A transmission dosimetry system is used to measure the amount of radiation penetrating the product, and this has proven to be of great practical value in continuously monitoring the overall irradiation process as the products are conveyed past the electron beam scanner. If the level of residual radiation fails to satisfy given pre-set limits, (as may be caused, for example, by a packaged product which is too thick), then the package is squirted automatically with a dye, and the operator is alerted with an audible and visual alarm. The dosimetry system, which is cross-checked against PVC film located behind the product carrier, also provides a feedback signal which can automatically adjust the speed of the conveyer to satisfy the requirements of a given integrated dose.

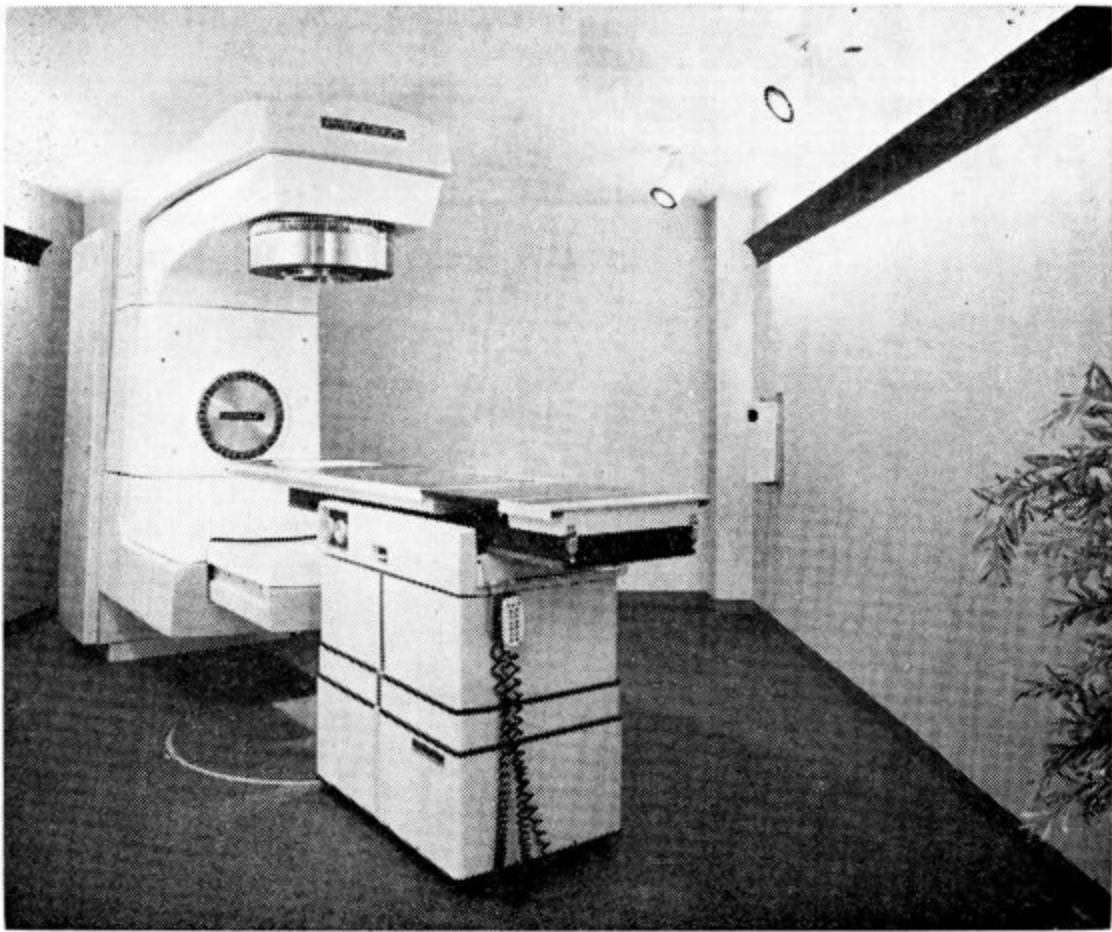

Figure 8. An ARCO 6MeV Radiotherapy Linear Accelerator System.

In the field of radiation sterilization, the work conducted at the Danish government atomic research center in Risø is well known and needs little further elaboration. This facility, commissioned in the early 1960's, comprises a two section S-band 10 MeV electron linear accelerator, and a 90° bending magnet which directs the beam vertically downward through a beam scanner to a simple single-pass conveyor system. Another facility involved in radiation sterilization processing, RADEST A/S (a commercial service group in Denmark), has accumulated more than 10,000 hours of plant operation using a 10 MeV, 10 kW S-band electron linear accelerator of more recent design.

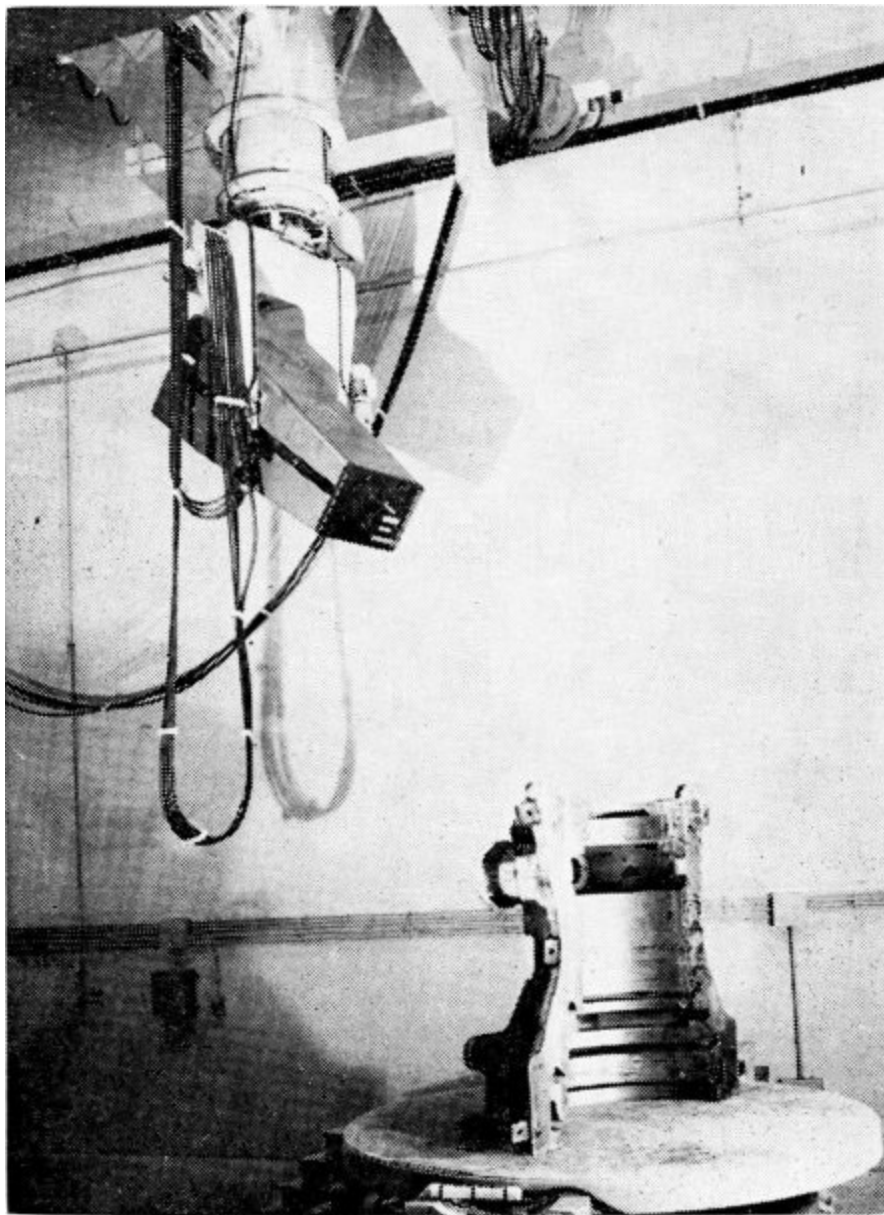

Figure 9. A Thomson-CSF 6MeV Industrial Radiographic Linear Accelerator.

Discussion of Theory and Beam Performance

It is intended that only a brief discussion of the theory of travelling wave linear accelerators be presented in this paper. For a detailed review of linear accelerator theory, the reader is referred to reference 12.

A most important initial requirement in the evaluation of an accelerator design is the accurate prediction of the beam performance as determined from chosen RF parameters. Since the gain in energy of the electron beam is determined by the distribution of longitudinal E field within the accelerator waveguide, it is necessary to determine the relationship between this field and the microwave parameters of the waveguide.

Under synchronous conditions, the energy imparted to an electron in a travelling wave linear accelerator may be written:

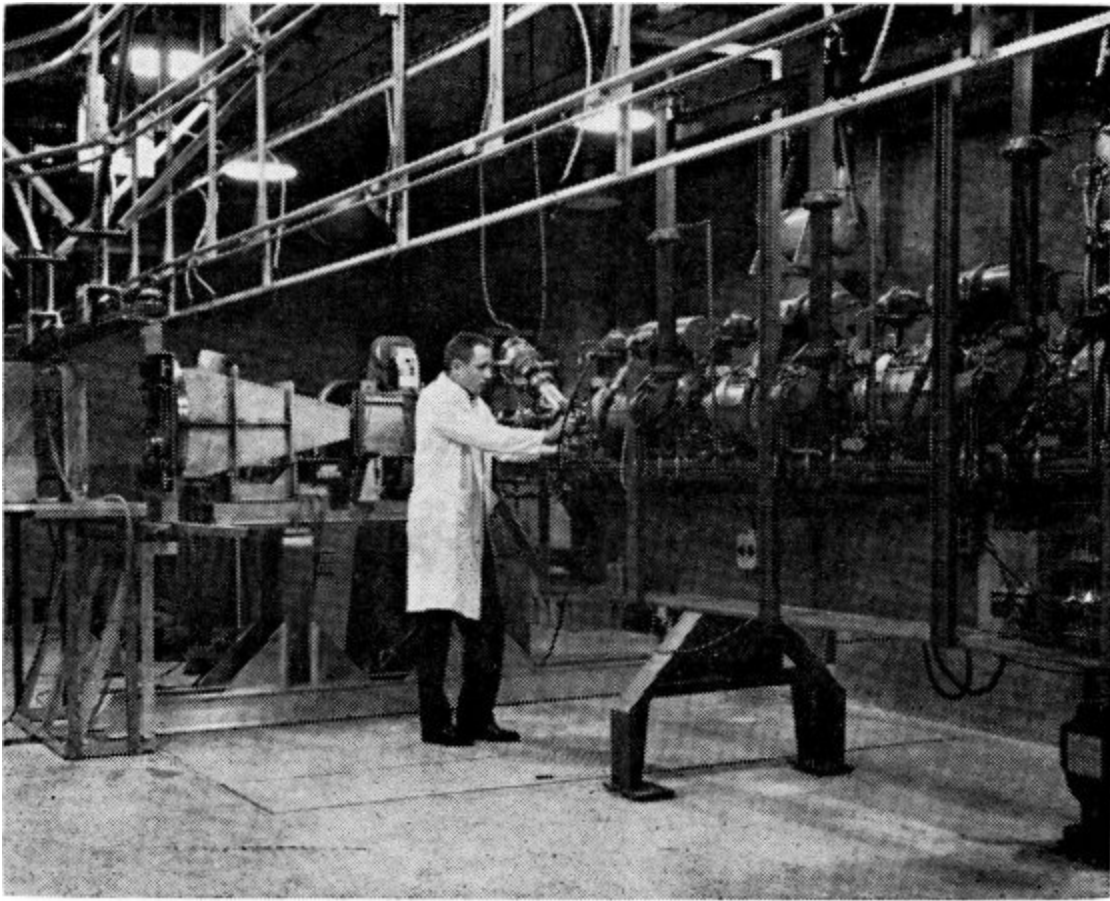

Figure 10. View of the US Army Natick Laboratory's 25MeV Electron Linear Accelerator Used for the Radiation Preservation of Food.

$$V = \int_0^L E_z dz \tag{1}$$

where E_z is the resultant of two superimposed field components:

- (a) the value, at the position of the electron, of the longitudinal electric field, the Fourier component of which is synchronous with the electron, and
- (b) the electric field in phase, and associated with the electron bunch, i.e., the beam loading component.

Defining α as the voltage attenuation per unit length of the accelerator structure, then for a waveguide of constant geometry (uniform impedance), the resultant longitudinal electric field may be written:

$$E_z = E_0 e^{-\alpha z} \cos \theta - ir(1 - e^{-\alpha z}) \tag{2}$$

where E_0 is the axial electric field at the beginning of the accelerator waveguide, θ the phase displacement of the electron from the position of peak accelerating field, i the peak beam current, and r the shunt impedance per unit length of the accelerator waveguide.

The shunt impedance r is a very important parameter in accelerator waveguide design since it determines the effectiveness of a microwave structure to accelerate charged particles. It is defined as the ratio of the square of the longitudinal electric field to the RF dissipated per unit length of waveguide structure.

Integrating Equation (2) over the length L of the waveguide, and letting $\alpha L = \tau$, gives the electron

Single user license provided by AAMI. Further copying, networking, and distribution prohibited.

energy gain as

$$V = E_o L K \cos \theta - irL(1 - K) \quad (3)$$

where $K = [1 - \exp(-\tau)]/\tau$.

Since the power attenuation may be written as

$$P_z = P_o \exp(-2\alpha z), \quad (4)$$

then from the definition of shunt impedance we can write

$$E_o^2 = 2\alpha r P_o \quad (5)$$

This enables the energy gain to be expressed in terms of the peak input RF power as

$$V = L[(2\alpha r P_o)^{1/2} K \cos \theta - ir(1 - K)] \quad (6)$$

$$\text{or } V = V_o - irL(1 - K) \quad (7)$$

where V_o is the maximum available beam energy, sometimes referred to as the “zero beam loaded” energy. More rigorous theoretical methods take into account variations of cavity geometry along the waveguide, small energy losses due to bunching in the initial portion of the structure, and departures in phase between the electron bunches and the travelling wave due to waveguide temperature or frequency changes. Instead of using a uniform structure as discussed above, an improvement in accelerator performance can be obtained by reducing successively the iris diameters along the waveguide. With this technique, it is possible to establish a constant accelerating gradient along the full length of the waveguide. With a constant gradient (zero loading) structure, the energy gain is given by

$$V = V_o - \frac{1}{2} irL \{ 1 - [2\tau \exp(-2\tau)] / [1 - \exp(-2\tau)] \} \quad (8)$$

where the unloaded beam energy is

$$V_o = \{ rLP_o [1 - \exp(-2\tau)] \}^{1/2} \quad (9)$$

For both types of structure, the energy gain Equations (7) and (8) indicate that the linear accelerator has a straight line loading characteristic, and that a specific electron beam current and/or energy may be obtained with different combinations of guide length L , peak RF input power P_o , shunt impedance r , and total attenuation τ . For a given guide configuration and operating frequency, the unit length shunt impedance r is a slowly varying function and, to first order, may be considered constant.

In practice, the final selection of parameters, particularly the waveguide length and the RF power level, depends greatly upon available space, operational economics and experience. Choice of the RF power source is clearly restricted to available tube types with a preference toward selecting the lowest possible peak power in order to minimize power supply ratings and replacement costs. Furthermore, since most linear accelerator manufacturers have established circuitry, assembly layouts, and operational experience with a range of particular RF tube types, the tendency is to select a specific peak power

rating in this range as close to the desired value as possible, for example, 2, 4, 10, or 20 megawatts, and then optimize the remaining parameters to provide the required electron beam characteristics.

Electron Beam Performance

The microwave design parameters of an accelerator waveguide can be chosen specifically to ensure an optimum performance for a particular application, viz., the attainment of a maximum X-ray output at a given beam energy and input RF power, the demonstration of a very high conversion efficiency from RF to electron beam power, the reduction of energy spread due to microwave frequency variations, etc. For example, in designing a linear accelerator to produce a high power electron beam for sterilization purposes, since relatively low energies are desired, say, in the range 3 to 10 MeV, emphasis should not be placed on achieving the maximum energy gain per unit length of the accelerator waveguide. A far more appropriate design for this application is one that enables operating costs to be minimized by demonstrating a very high efficiency of conversion from RF to accelerated electron beam power. In this regard, the choice of τ , the total attenuation of the waveguide, greatly influences the performance of the linear accelerator.

The maximum conversion efficiency η_m from RF to beam power can be expressed¹³ in terms of the waveguide total attenuation τ for both the uniform and constant gradient structures, as indicated by Equations (10) and (11), respectively.

$$\eta_m = i_m V_m / P_o = \frac{1}{2} [1 - \exp(-\tau)]^2 / \{ \tau - [1 - \exp(-\tau)] \} \quad (10)$$

and $\eta_m = i_m V_m / P_o$

$$= \frac{1}{2} [1 - \exp(-2\tau)]^2 / \{ [1 - \exp(-2\tau)] - [2\tau \exp(-2\tau)] \} \quad (11)$$

where i_m , the peak current that results in maximum conversion efficiency, is such that the electron energy is reduced to one-half of the no load value, i.e., $V_m = \frac{1}{2} V_o$.

This maximum beam power characteristic is typical of modern high current linear accelerators; and is illustrated by the straight line loading and beam power graphs shown as solid lines in Figure 11.

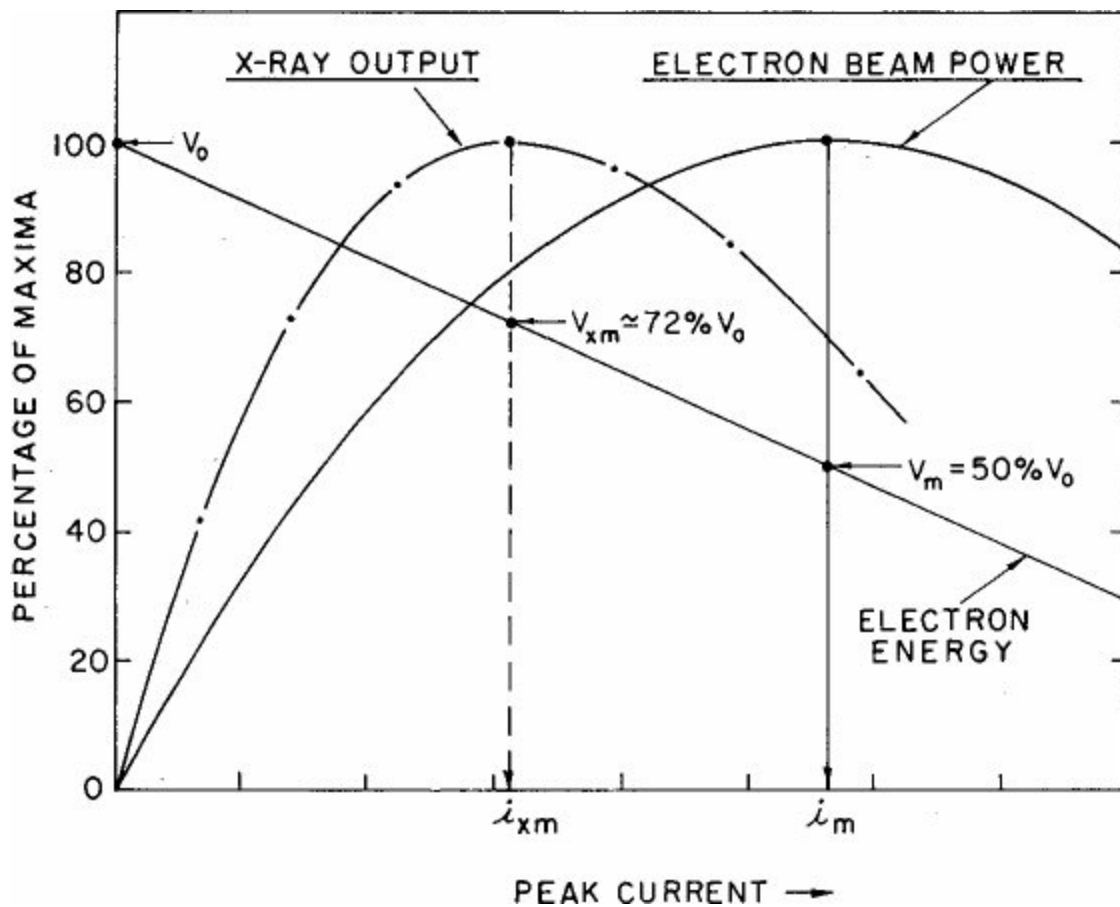

Figure 11. Linear Accelerator X-ray and Electron Beam Loading Characteristics.

It is of interest to note that Equations (10) and (11) both indicate that the maximum conversion efficiency approaches 100% as the waveguide attenuation tends to zero. These equations, shown plotted in Figure 12, indicate that for practical values of τ , say, between 0.3 and 0.1 neper, maximum conversion efficiencies of between 80 and 90% may be expected. Verification of this high efficiency characteristic was first reported more than 10 years ago¹⁴ with the demonstration of greater than 85% conversion with a 10 MeV high current linear accelerator. Progress continues to be made in this area, and it is predicted that by the end of this year a conversion efficiency in excess of 90% at a beam energy of 5.5 MeV will be demonstrated with an advanced design high power linear accelerator presently in construction.

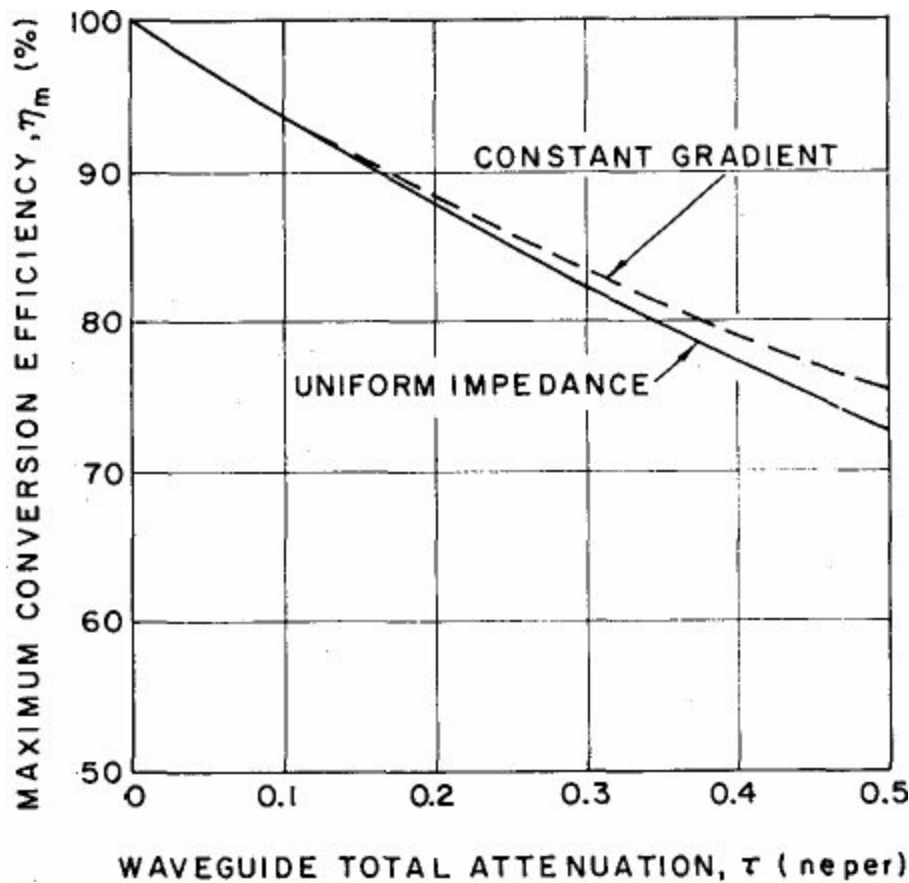

Figure 12. Conversion Efficiency of Input RF to Output Beam Power Versus Accelerator Waveguide Attenuation.

To avoid any misunderstanding, the reader should note that the overall efficiency of the accelerator depends also on the conversion of ac power to RF power as discussed in a later section.

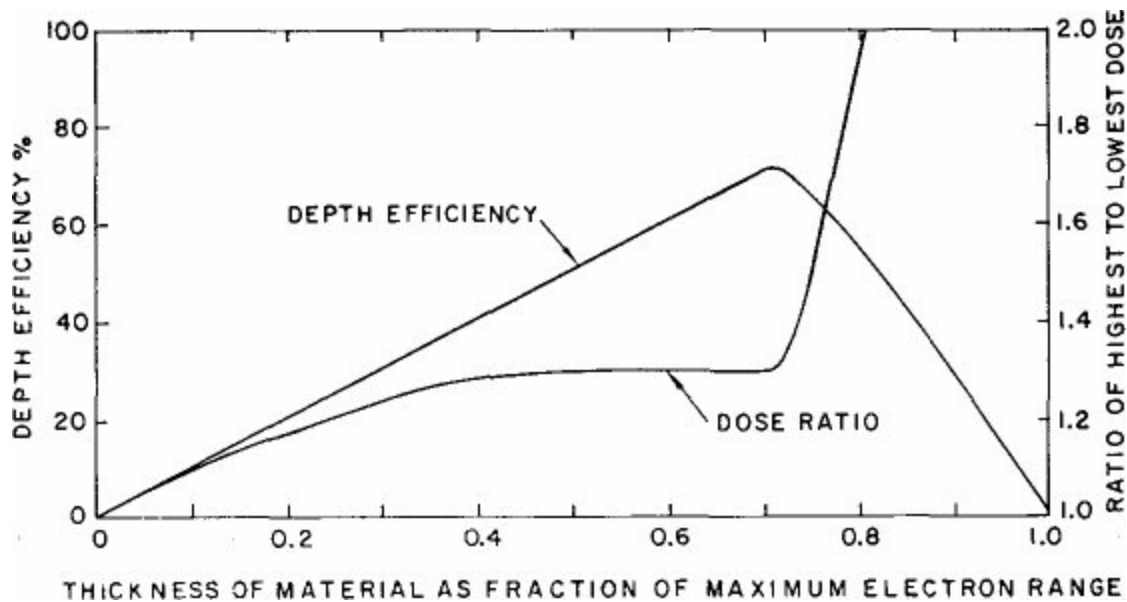

Figure 13. Electron Depth Dose Efficiency Characteristics — Radiation Incident on One Side Only.

In selecting a machine to irradiate a range of products which may vary in thickness and/or density, and especially when planning for possible future products, serious consideration must be given not only to the choice of an appropriate nominal energy but also to the selection of a system which can, with convenience, provide a relatively wide range of energies on either side of the nominal value. The importance of selecting a beam of adequate energy can best be illustrated by examining the sensitive

dependence of the depth dose efficiency on the thickness of irradiated material. As an illustration, the relationship of depth dose efficiency to material thickness plotted as a fraction of the maximum electron range is shown in Figure 13. Also shown is the accompanying dose variation through the material plotted as a ratio of highest to lowest dose. (These particular data were plotted from depth dose curves obtained using an extrapolation chamber with added polystyrene absorbers at an electron energy of 6 MeV — radiation incident on one surface only.) For this condition of a single incident surface, the maximum depth efficiency occurs when the thickness of the irradiated material is approximately 70% of the electron range.

As an example, with a 1 cm thick product of unit density material, an incident electron energy of 2.9 MeV is required to achieve maximum depth efficiency; and to maintain this efficiency when the product thickness is increased by only 3 mm, the electron energy must be increased to 3.8 MeV. In providing this type of operational flexibility, it is clearly desirable that the available beam power should remain relatively constant over the range of energy settings. An examination of the Figure 11 operating characteristics reveals that the linear accelerator is ideally suited to provide this type of flexibility.

The capability of the linear accelerator to operate over a range on either side of its nominal rating without substantial loss in beam power may best be illustrated with a numerical example as follows. Choosing an input RF peak power level of 2 MW and a beam duty factor of 2% at an operational frequency of 2856 MHz, allows the use of presently available transmitter components. For a constant gradient travelling wave structure of 1.3 meter length having an attenuation parameter $T = 0.2$ neper and a shunt impedance of 54 megohm/meter, from Equation (9), the unloaded beam energy is 6.8 MeV; and the beam performance as obtained from Equation (8) is listed in Table I. These data indicate that between 31 and 35 kW of average beam power can be maintained over an energy range from 2.5 to 4.5 MeV. For operation at the lower values of beam energy, alternative procedures, such as reducing the input RF power level, may be adopted. A duty factor of 2% is quite conservative with systems of modern design; and, if required, this could be increased to 3%, thereby providing 50% more beam power at the same electron energies.

Table I. — Variation of beam power with electron energy

for $f = 2856$ MHz, $L = 1.3$ m, $T = 0.2$ Np, $P_o = 2.0$ MW and Duty = 2%

Beam Energy (MeV)	Peak Current (mA)	Average Current (2% Duty) (mA)	Average Beam Power (kW)	RF to Beam Conversion Efficiency (%)
5.0	275	5.5	27.5	68.7
4.5	350	7.0	31.5	78.7
4.0	425	8.5	34.0	85.0
3.5	500	10.0	35.0	87.5
3.0	575	11.5	34.5	86.2
2.5	650	13.0	32.5	81.2

By adjusting the waveguide parameters, the accelerator can be designed to provide peak performance over a higher range of energies. As an example, with a 1.5 meter waveguide having $r = 53$ megohm/meter and $T = 0.2$ neper, with an input peak RF power of 2.8 MW and a beam duty factor of 1.5%, an average beam power in excess of 30 kW can be maintained over an energy range from 3.5 to 6 MeV, as indicated in Table II. A substantial level of beam power can still be delivered up to an energy of 8 MeV with this design of waveguide.

X-ray Beam Performance

That the linear accelerator has proven to be a prolific and reliable source of X-rays is evidenced by the large number of these machines in daily clinical use in radiotherapy departments throughout the world.

During the 25 year evolution of the medical linear accelerator¹⁵, a variety of industrial radiographic machines was also developed, some of which were designed to operate at extremely high intensities. Since the linear accelerator is capable of producing megavoltage X-ray beams of high intensity, and because these beams may be effectively directed and applied with relatively large cone angles¹⁶, it is apparent that this form of radiation, in addition to direct electron bombardment, is also available for sterilization purposes. In the energy range under consideration, say 3 to 10 MeV, the central axis X-ray intensity produced by an electron beam incident upon a thick high Z target may be expressed empirically as:

$$X = k i_{AV} V^n \quad (12)$$

where X is the dose rate in rads per minute at a meter, k is a constant at 0.07, i_{AV} is the average target current in microamperes, V is the energy of the incident electrons, and n is an exponent which varies from approximately 2.75 at 4 MeV to approximately 2.65 at 10 MeV. It may be shown¹⁷ that the X-ray beam intensity from a linear accelerator is maximized when the beam current has a value i_{xm} given by

$$i_{xm} = V_o / [rL(1-K) (1 + n)] \quad (13)$$

and that the beam energy at this value of current is

$$V_{xm} = V_o - i_{xm} rL (1 - K), \quad (14)$$

with symbols as defined in Equation (3). The above equations indicate that the maximum X-ray output is achieved at a beam energy V_{xm} which is approximately half way between V_o and V_m . This characteristic is illustrated in Figure 11 by the broken curve which shows the linear accelerator X-ray output dependence on the electron beam parameters.

As an example, for the linear accelerator of Table II, at an electron beam energy of 6 MeV, the maximum central axis X-ray intensity would be between 35,000 and 45,000 rads per minute at a meter, depending on target thickness and material, and the design of the primary collimator, e.g., 2500 rads per second at 50 cm with a 10% dose uniformity for a field within a 15° included cone angle. Although this exposure rate is some three orders of magnitude lower than that of the directly extracted electron beam, there may well be applications which benefit from the much greater penetration of the X-ray beam and the reduced level of ozone production.

Table II. — Variation of beam power with electron energy

for $f = 2856$ MHz, $L = 1.5$ m, $T = 0.2$ Np, $P_o = 2.8$ MW, and Duty = 1.5%

Beam Energy (MeV)	Peak Current (mA)	Average Current (1.5% Duty) (mA)	Average Beam Power (kW)	RF to Beam Conversion Efficiency (%)
Single user license provided by AAMI. Further copying, networking, and distribution prohibited.				

7.0	200	3.0	21	50.0
6.5	267	4.0	26	62.0
6.0	333	5.0	30	71.4
5.5	400	6.0	33	78.6
5.0	466	7.0	35	83.2
4.5	533	8.0	36	85.7
4.0	600	9.0	36	85.7
3.5	667	10.0	35	83.3

Continual Improvement of System Reliability

A critical comparison of modern linear accelerator operational experience with that of earlier models reveals that, over the years, a dramatic improvement has occurred in system reliability. In addition to a steady trend of improvement, as is to be expected over a 25 year period of continual evolution, several well defined step-function increases in reliability and longevity of particular subsystems have been effected by outstanding design innovations.

With linear accelerators of early design, operational difficulties and excessive maintenance were frequently associated with the vacuum system, refrigeration equipment (a common requirement for early radiotherapy machines — many of which were installed in hot climates), microwave matching of the RF source, sensitivity of the modulator switch tube, and premature failure of the electron gun filament (usually due to embrittlement). An estimated 10 to 20 days per year were required for maintenance and service of these early (mid-1950) machines, most of which, incidentally, operated long shifts on a daily basis for periods of greater than 10 years. A comparison of these maintenance schedules with the less than 3 days per year commonly budgeted for modern linear accelerators, handling the same daily throughput at an identical energy and beam power, is indicative of the trend which has occurred in machine reliability.

The improved reliability of modern linear accelerator systems can be ascribed to a great number of developments, the most dramatic of which resulted in the removal rather than the modification of subsystems which were considered of marginal value. For example, critical refrigeration and water cooling evaporator systems were dispensed with completely by simply redesigning the accelerator waveguide structures to provide the desired operational phase velocities at a temperature of 40° or 45°C instead of 20°C as in the early machines. Thus, water cooling systems became water “heating” systems, with the attendant advantages of a simple thermostatically controlled heater.

As another example, use of the sputter-ion vacuum pump¹⁸, and more recently the high speed triode pump, proved to be one of the major contributions towards reducing accelerator maintenance and increasing operational reliability. This development (a), permitted the removal of oil diffusion pumps, the oil heating and cooling equipment, the on-line roughing pumps and backing pressure protection circuitry, cold traps and accessories, etc.; (b), enabled the construction of highly reliable all-metal (bakeable) hard vacuum systems that operated at one or two orders of magnitude improvement in vacuum; (c), allowed ionization and penning gauge equipment to be removed since the ionization current of the sputter-ion pump provided an accurate means of measuring the system vacuum; and (d), permitted a greater degree of freedom in system design since the sputter-ion pump could operate in any orientation. This latter feature played a dominant role in the successful development of the first radiotherapy linear accelerator which provided 360° of rotation around the patient¹⁹.

Figure 14 depicts the marked reduction in service and maintenance which occurred when oil diffusion pumps were replaced by sputter-ion pumps in linear accelerator demountable vacuum systems. Initial difficulties were encountered during the first attempt, in the late 1950's, to fit sputter-ion pump equipment to a linear accelerator driven by a high power klystron. These problems were resolved, however, and this work led the way to the subsequent construction of a large number of electronically pumped linear accelerator systems.

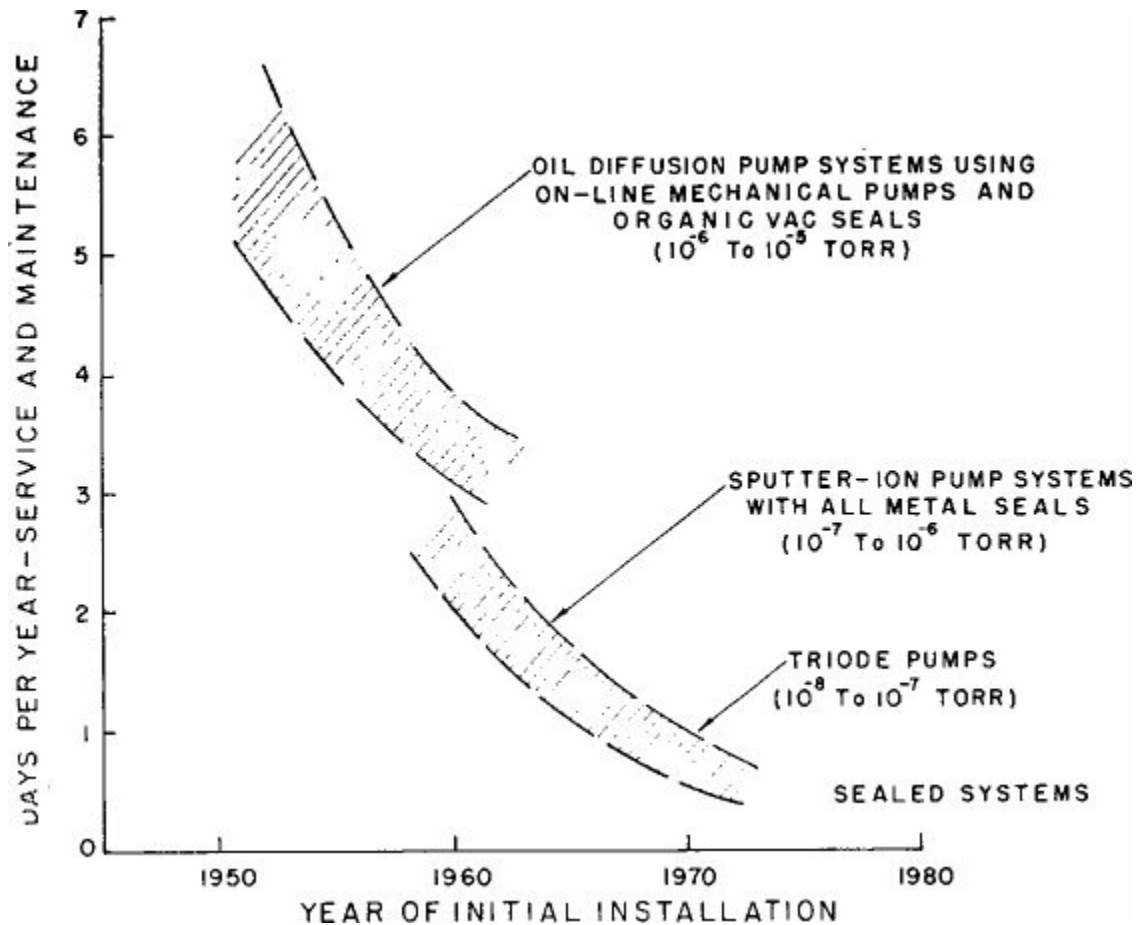

Figure 14. Trend of Reduced Maintenance and Service for Linear Accelerator Demountable Vacuum Systems.

Advances in high power transmitter switch tube design saw the temperamental ignitron replaced by the long life, stable hydrogen thyratron; and shortly thereafter, with the advent of solid state technology, transmitter and control circuitry was virtually revolutionized.

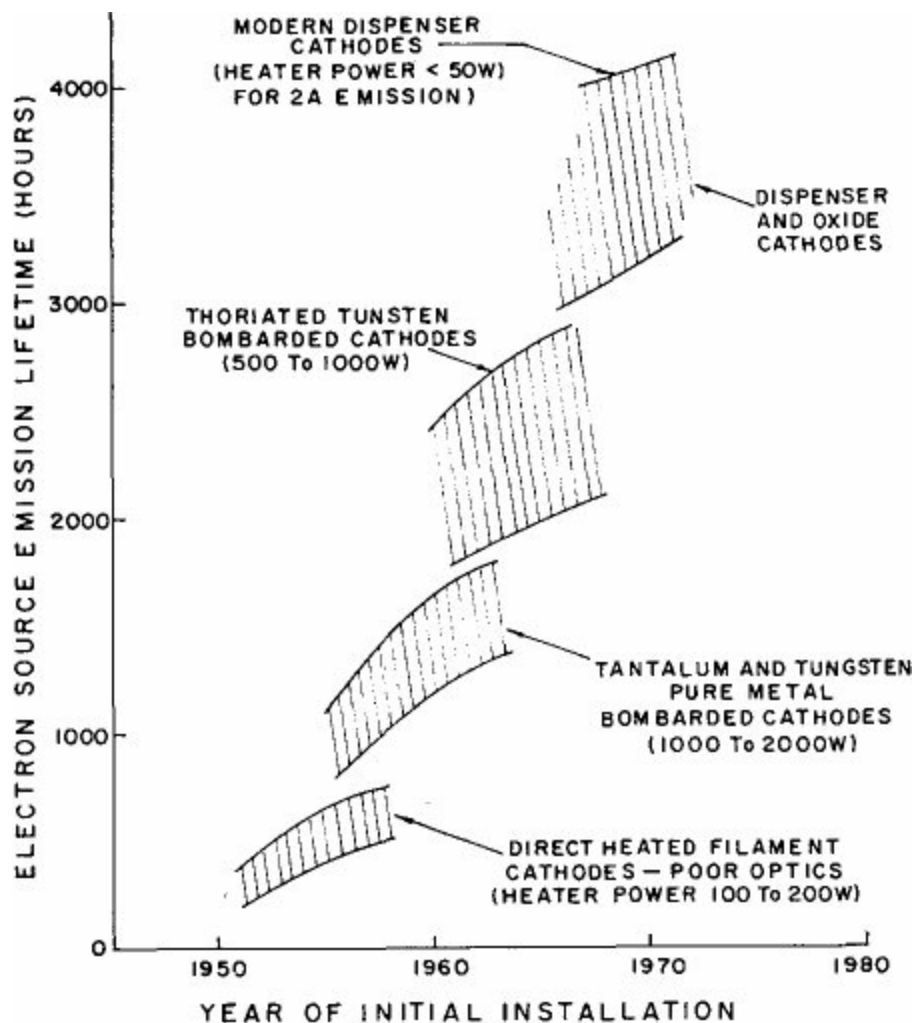

Figure 15. Lifetime Improvement Trend for Electron Sources Used in Linear Accelerator Systems.

Contributions to the improvement of accelerator reliability continued to be made through the 1960's with the use of high temperature alloys and hydrogen furnace brazing procedures for waveguide construction, and with further development of high power microwave tubes. For example, magnetrons were fitted with tuning plungers which enabled the frequency to be adjusted; and klystron type high power RF ceramic windows were coated with titanium oxide to prevent multipactor damage and premature failure. Modern high power klystron tubes can now be expected to operate for 10,000 hours²⁰ as compared to earlier tube lifetimes of 1000 to 2000 hours.

The continual design and development of electron guns and cathodes has resulted also in a number of major improvements in accelerator reliability. The 20 year trend of electron source emission lifetime shown plotted in Figure 15 is a conservative illustration of the degree of improvement which has been gained with each new cathode development. It should be noted that the more recent improvements in cathode lifetime can be attributed directly to the corresponding improvements in the quality and reliability of the modern accelerator vacuum system, as previously indicated in Figure 14.



Figure 16. Assembly of a High Power Travelling Wave Accelerator Tube Prior to Brazing.

An outstanding advantage of the microwave linear accelerator is that the short, all-metal, waveguide structure is also the high voltage accelerating “column”, and all the outside surfaces are at dc ground potential. This permits direct access to the accelerating tube; and construction features such as full length water cooling tubes, beam focusing coils, and vacuum ports can be fitted with simplicity and convenience. This unique feature permits the beam performance to be optimized without compromising the high voltage integrity of the accelerating tube and, to some extent, indicates why, after being placed into operation, accelerator waveguides seldom require servicing or replacement.*

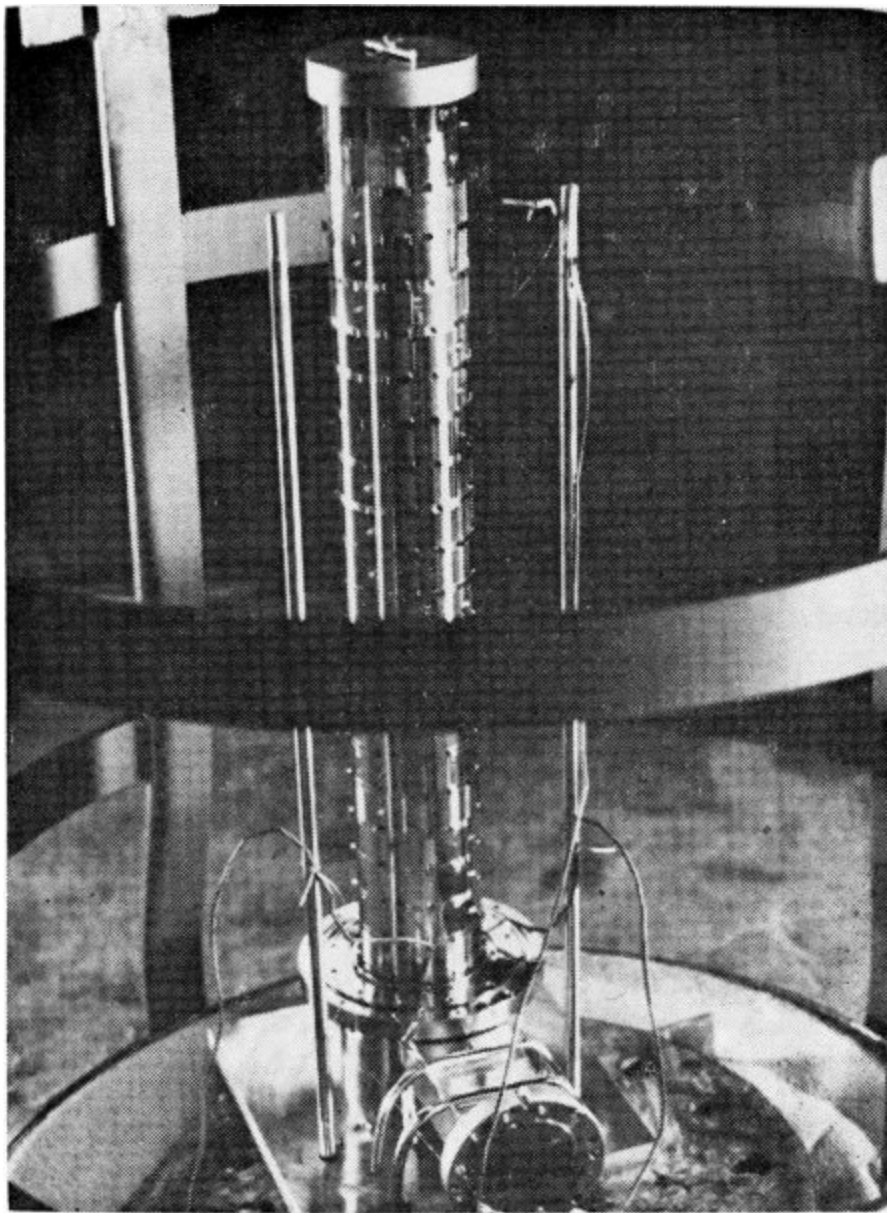

Figure 17. View of Accelerator Tube and Input Coupler Assembly with Thermocouples Fitted in Preparation for Hydrogen Furnace Brazing.

Figures 16 and 17 show initial assembly and subsequent hydrogen furnace brazing, respectively, of a high power S-band accelerator waveguide. The accelerator tube shown in these photographs has an electron beam average power rating of 30 kW at an energy of 5 MeV.

Recent Achievements and Developments

Quite apart from improvements in operational reliability, linear accelerator technology has advanced in recent years due to several important developments of a theoretical and practical nature. From the point of view of radiation processing, perhaps the single most important advance has been the successful operation of high duty factor²¹ electron linear accelerators. These new machines operate with maximum beam duty factors in the range of 1% to 10% as compared to the previously available conventional duty factor of 0.1%. The superior beam power performance of these high duty microwave accelerators has been discussed earlier in this paper, and some typical operational characteristics are listed in Tables I and II.

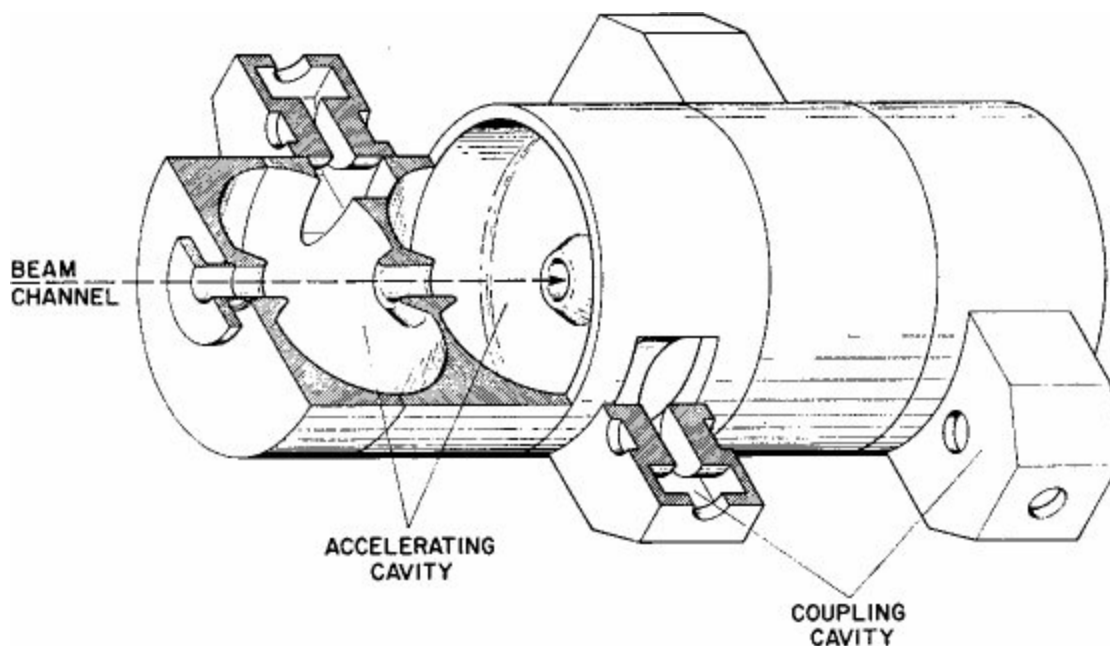

Figure 18. Cut-away View of Los Alamos Side-Wall Coupled Standing Wave Cavities.

High duty factor electron beam performance has now been demonstrated with both travelling and standing wave linear accelerators. Such demonstration using travelling wave S-band linear accelerators was made possible primarily through the results of a series of independent research programs which investigated microwave methods of avoiding beam instabilities, and which led to the development of new klystrons and injection systems. Special design efforts were also necessary to prevent undesirable phase shifts in microwave components which were subjected to the new higher levels of average RF power. In the case of the standing wave machine, a notable advance in waveguide technology was the Los Alamos development²² of the side-wall coupled cavity, a cutaway view of which is shown in Figure 18. This two cavity per wavelength structure combines the stability advantages of a four cavity per wavelength ($\pi/2$) system with the high shunt impedance characteristics of a π mode structure. (At the same operational frequency, the shunt impedance of this structure is approximately 60% greater than a 3 cavity per wavelength disc loaded waveguide.)

It should also be noted that accelerator operation at high duty factor became a practical reality because of the availability of long life high average power klystrons. For example, at S-band frequencies there are at least two manufacturers offering klystrons rated at 4 MW peak and 100 kW average RF power. Since these tubes can be operated at reduced levels of peak power, as low as 1 MW, while the average power rating is maintained, they can provide a range of RF duty factors from 2½% to 10%.

On-going laboratory research programs which emphasize computer assisted beam optics analyses and which are supported by full scale experimental beam tests are of extreme importance in the continual advancement of linear accelerator technology. Rigorous investigations of this nature have led to the development of a range of specialized components including high performance electron guns of very small dimensions, long-life high potential pre-accelerator columns, new waveguide structures, and advanced design magnetic focusing systems. Components in the latter category are used to control the focal dimensions of high energy electron beams. A selection of these low aberration, low dissipation (non-water cooled), high strength magnetic lens assemblies is shown in Figure 19.

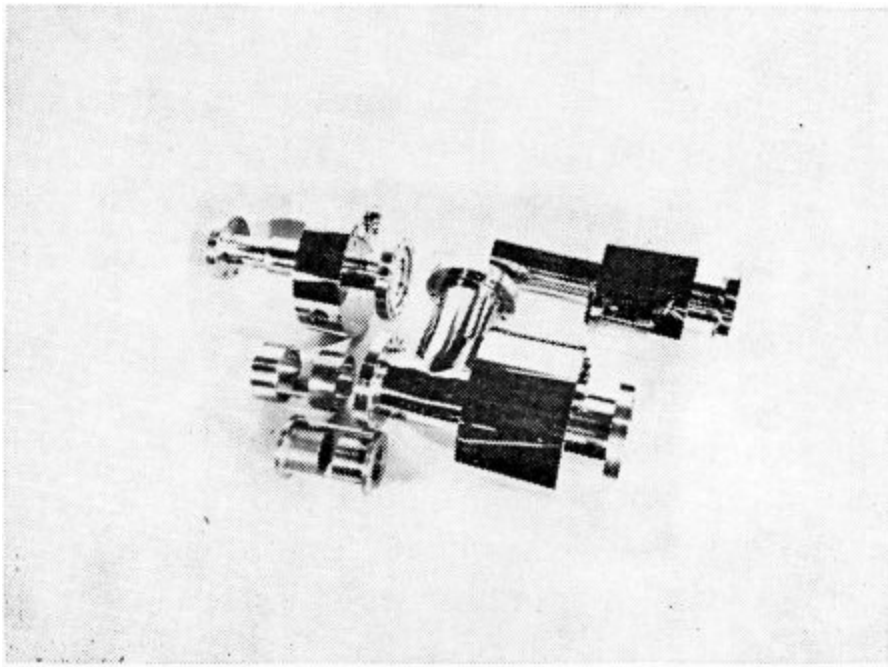

Figure 19. Selection of Low Dissipation, High Strength Magnetic Lens Assemblies Constructed from Radiation Resistant Materials.

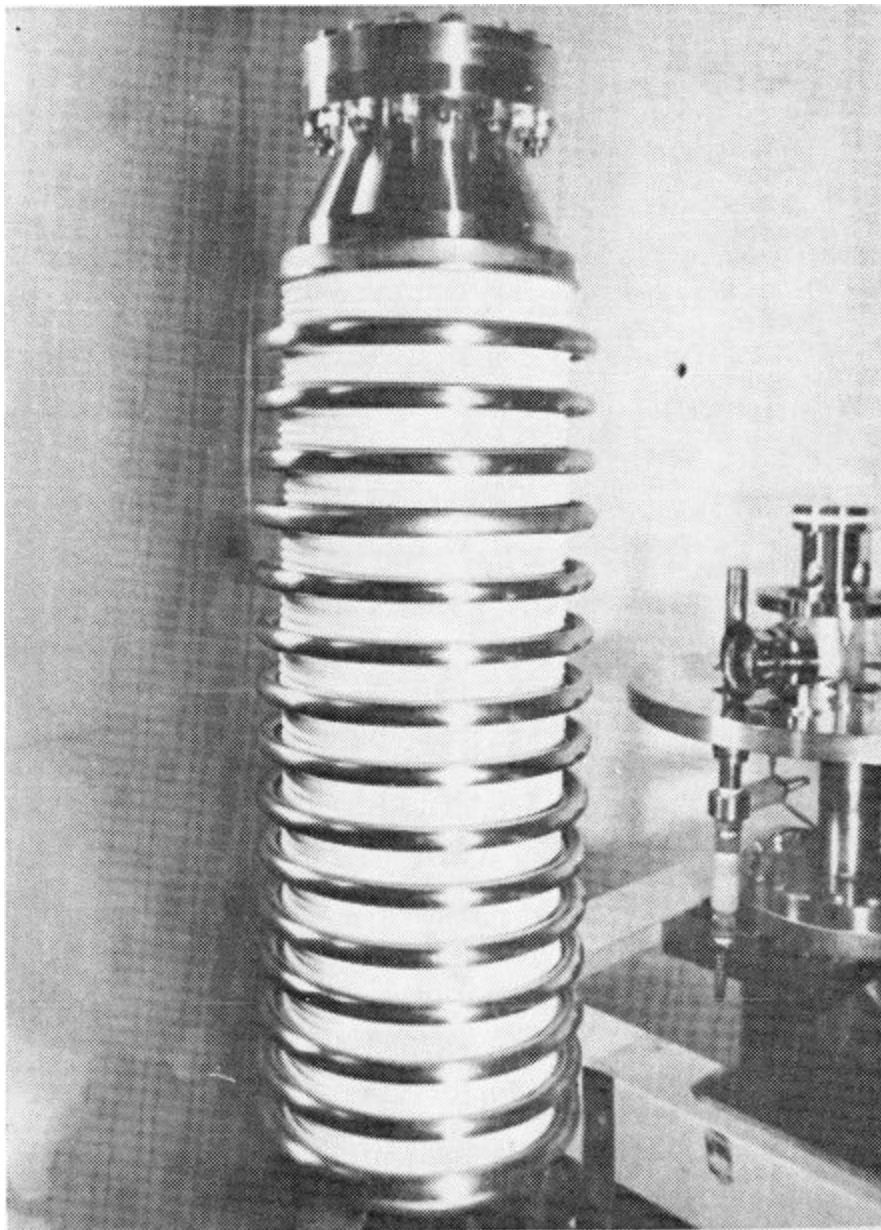

Figure 20. 500kV Electron Gun Assembly Including a Metal and Ceramic All-Brazed Potential Dividing Column.

An important recent achievement, especially for high duty factor accelerators, has been the development of a series of highly stable electron injectors which operate in the range of 150 to 750 kV. These systems contain long-life electron sources of small dimensions and dc accelerating columns which produce high power beams of very low divergence. Figure 20 shows an example of an advanced design electron gun for a high power linear accelerator. This injector has a dc potential rating of 500 kV; and because the column is a high temperature brazed integral assembly, constructed entirely with metal and ceramic components, it operates in the 10^{-8} Torr range at full beam output. Computer techniques, which provide the designer with valuable assistance in avoiding problems caused by field emission and back bombardment (thereby assuring reliability and long life), are used to generate the contours of the metal and ceramic components in these electron injector assemblies. Figure 21 shows another electron gun, a 300 kV 2 ampere system, installed in the injector tank of a high power 10 MeV linear accelerator which is presently under construction in the HRC laboratories. Use of such metal and ceramic all-brazed electron gun assemblies, in combination with high temperature brazed all-metal accelerating tubes, ensures that the beam centerline components of modern linear accelerators are fully

hardened against the life-time reducing effects of radiation damage.



Figure 21. View of a 300kV, 2 Ampere Electron Gun Installed in the Injector Tank of a High Power 10MeV Linear Accelerator.

In concluding this section, mention should be made of an achievement which, on the surface may not appear significant but which holds promise of leading to a major advance in the development of high current accelerators of the type that would benefit the radiation processing industry. For over two decades, the spectral quality of electron beams produced by linear accelerators has improved continuously from early best values of 10% to present day best values of approximately 0.1%. The divergence properties (emittance) of these beams, however, has remained relatively unchanged due mainly to the repeated use of conventional injection systems. The recent adoption of new design parameters led to the injection of very small dimensioned electron bunches which, coupled with a long focal length electron gun, resulted in accelerated electron beams of greatly reduced emittance²³.

A beam having substantially reduced values of transverse phase space (emittance) and longitudinal phase space (bunch length) can, with an increasing degree of success, be recycled through the same accelerator several times by using a suitable set of beam bending magnets. The successful demonstration of very low emittance accelerated electron beams now increases the feasibility of the beam recycling concept and offers a candidate machine for radiation processing. Because of its future potential, this

concept is discussed separately in an Appendix to this paper.

Limitations and Advantages

The microwave linear accelerator is essentially a high impedance device and as such is best suited for the conversion of peak RF power to electron beams of relatively high energy and low current. Although recent advances have enabled the acceleration of larger values of average current, as shown for example in Tables I and II, for economic reasons, linear accelerators are seldom considered for applications requiring maximum beam energies of below, say, 2 or 3 MeV. However, for applications which require electron beam energies exceeding 2 or 3 MeV, the high power linear accelerator becomes an increasingly more attractive and economic candidate for a radiation processing facility.

The economic viability of the linear accelerator becomes apparent when it is noted that the capital expenditure and operational cost of a conventional 3 MeV 30 kW linear accelerator are essentially the same as those of a 6 MeV 30 kW linear accelerator, i.e., the same machine covers this range of energies.

Although linear accelerator waveguides can be constructed to provide input RF to beam power conversion efficiencies of 80 to 90%, the system overall efficiency is influenced primarily by the lower conversion efficiency of ac input power to RF power. The efficiency of a high power klystron transmitter seldom exceeds 35%, while magnetrons and amplitrons operate with practical efficiency values of approximately 50 to 60%. Thus, the overall efficiency of a high power linear accelerator (transmitter efficiency multiplied by the waveguide conversion efficiency) seldom exceeds 30%, i.e., the ac power requirement is at least three or four times greater than the actual electron beam power.

Improvement of linear accelerator overall efficiency is perhaps the last remaining major challenge in this field, and this improvement will take place automatically with the development and availability of higher efficiency RF generators. Development work of this nature, recently spurred by the energy crisis, is currently in progress in a number of laboratories throughout the world. Since the linear accelerator centerline is independently optimized for high conversion efficiency, with the advent of more efficient RF generators, an increase in the efficiency of the overall system will be achieved by a simple retro-fit of the RF tube.

An operational advantage of the linear accelerator is the ease in which a given product dose may be controlled, monitored, and if necessary, locked to the requirements of the product throughput by a "tracking" feedback system. Also, because the linear accelerator operates in the pulsed regime, a given integrated dose may be delivered to the product at a variety of peak current values by selecting the appropriate pulse repetition rate, i.e., a certain degree of flexibility is afforded in selecting the value of peak current required to achieve a given average current.

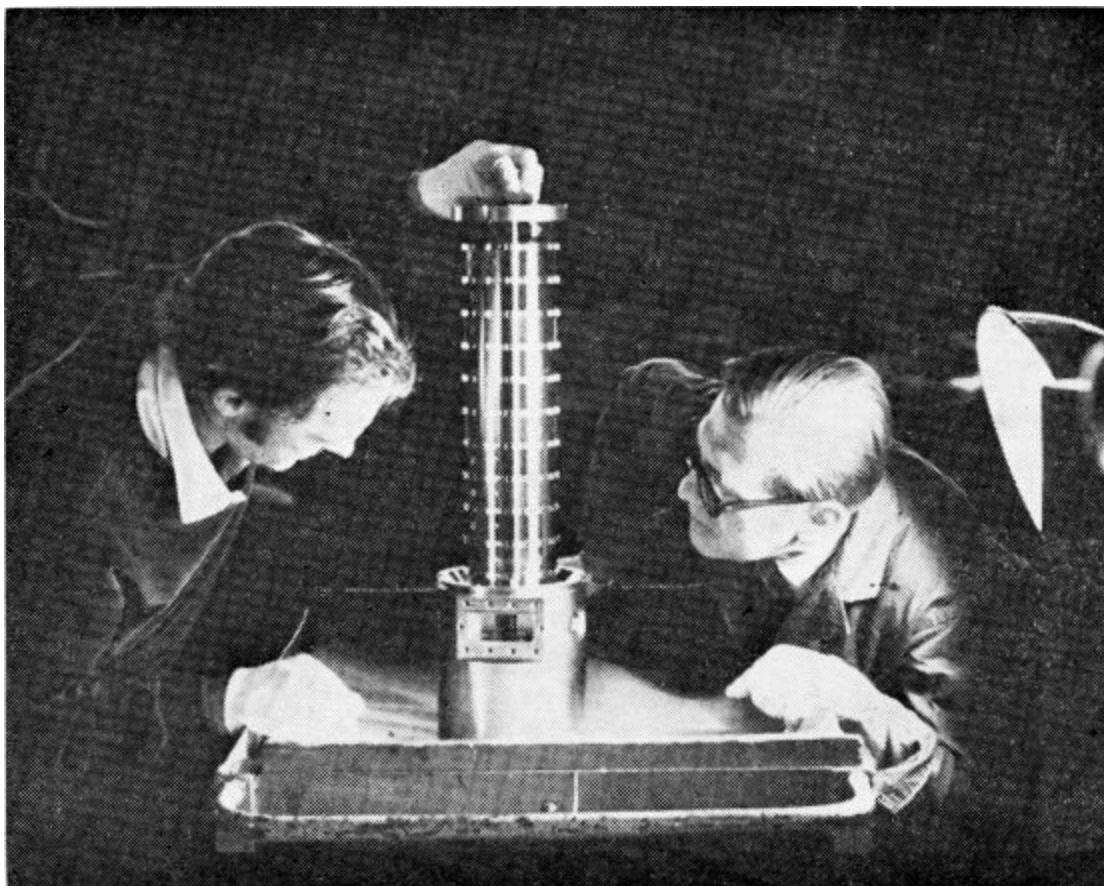

Figure 22. After-Braze Inspection of the Output Half of a High Power 6MeV Accelerator Tube.

The technical advantages of an all-metal accelerating tube have been enumerated in the previous discussion of machine reliability; in addition, the short length and robust construction, typified by the Figure 22 photograph, result in certain installation advantages. For example, a 10 MeV linear accelerator can be constructed with a beam centerline length of less than three meters; it requires no gas handling equipment or cold traps; and it can be installed in either the horizontal or vertical plane without special supports or operational limitations. A horizontal accelerator centerline offers the added advantage that a beam bending magnet may be used to direct the beam (usually downwards) onto the product, thereby providing a means of spectroscopically selecting and continuously monitoring the energy of the emergent electron beam. The quality and intensity of the radiation produced by a linear accelerator can be adjusted with ease to suit the particular requirements of the application; and, of course, when not required, the radiation can be terminated at the press of a button.

Summary

It is evident that vigorous development programs and rapid advances in electronic and microwave technology during the past few years have resulted in a dramatic improvement of the conventional linear accelerator. These advances have also enabled new generations of electron linear accelerators to emerge from the laboratory environment as reliable sources of intense radiation ideally suited for high throughput radiation processing. These new machines are simple and versatile, and there is little doubt that they will prove to be more reliable and economical than their heretofore available predecessors.

In the past, motivation for linear accelerator development was derived almost entirely from particle physics research, and megavoltage radiotherapy and radiography applications. It is particularly significant that, for each of these applications, the average current requirement was less than one milliamperere. (Only in recent years have average currents of significantly greater than one milliamperere been demonstrated.)

It should also be noted that, from the outset, the development of linear accelerators has been influenced predominantly by the availability of high power RF sources which, historically, proved to be megawatt pulsed devices such as the S-band magnetron and klystron.

Thus, in terms of producing relatively compact machines having high accelerating fields, both the motivation and the existing technology were in accord, and, as might have been expected, this resulted in rapid progress with the construction of a large number of successful high energy, low current accelerators. For radiation processing, however, the beam requirements are essentially the reverse, namely, high average current with energies usually restricted to a few MeV.

Faced with the task of constructing an economic and reliable machine, specifically designed for the radiation processing field, the microwave accelerator designer might well ask the following question. Within the bounds of present day technology, is there a method of optimizing a microwave system for accelerating high average currents, while retaining the high conversion efficiency of microwave to beam power demonstrated by low attenuation travelling wave linear accelerators? In seeking an answer to this question, it is helpful to choose a particular rating, say, 8 mA of average current at 4 MeV. This beam performance can be achieved with a microwave accelerator in several ways, for example, consider the following methods:

- Machine type A — by accelerating 8 amperes of pulsed current at the conventional duty factor of 0.1% — this would require three high peak power klystrons,
by accelerating 250 mA of pulsed current at a duty factor of 3.2% — this would
- Machine type B — require a single high duty factor klystron with a peak power of approximately 2 MW,
by accelerating 8 mA of average current at a duty factor of 100%, i.e., a
- Machine type C — continuous wave (cw) microwave accelerator — this would require a cw RF source of approximately 50 kW.

Machine types A and B are within the state of the art today; and both types, with guaranteed performance specifications, can be constructed at the present time. (Although of different microwave design, both of these linear accelerators would have accelerator tubes of comparable total length, e.g., approximately one meter). For economic reasons, however, machine A is not an acceptable choice because its capital cost is approximately 60% higher than machine B, and because of the much higher operational costs associated with a three klystron RF system as compared to a single klystron machine. A practical difficulty is also presented by machine A due to high current pulse heating of the extraction window. The single klystron, high duty factor system, type B, would therefore be the logical choice in terms of the lowest cost presently available linear accelerator with a proven record of system reliability.

The cw concept of machine C, above, warrants special consideration since it is this technique which holds the most exciting prospects for future high beam power accelerators having energies of up to a few MeV.

A particularly advantageous feature of a cw RF system is that a dc power supply and a small, low (peak) power RF tube is used in place of the larger, more expensive, and less efficient multi-megawatt peak power pulsed transmitter. Although pulsed radar style transmitters have a record of demonstrated reliability, they contain high voltage and pulse current components which account for a major fraction of the total construction cost of a high peak power microwave linear accelerator. On the other hand, a major disadvantage of the cw technique is that a marked reduction occurs in the strength of the RF accelerating field, due to the much lower level of input RF power. Since the gain in energy V of an electron in traversing the accelerator structure is given by $V = [rL(\Delta P)]^{1/2}$, it can be seen that if the power dissipated ΔP in the walls of the structure is reduced, then the length L and the shunt impedance r must be increased in order to avoid loss of beam energy.

For the 8 mA beam example quoted above, the copper losses ΔP would be reduced from approximately 400 kW (peak) in the pulsed machine B to about 20 kW in the cw machine C, i.e., ΔP would be reduced by a factor of approximately 20. With a power reduction of this magnitude, it is clear that an attempt to re-establish the beam energy by increasing the length of the machine to 20 meters would be impractical. Using the technique described below, however, it is possible to achieve with a relatively small machine, electron energies of several MeV while operating in the cw regime.

Consider a linear array of standing wave cavities, with an overall length of less than 2 meters and optimized in design to provide a high value of shunt impedance. Then by choosing a low value of operating frequency to avoid undesirable phase sensitive conditions, as discussed below, it is possible to maintain constant (or even increase) the product rL in comparison with a one meter long travelling wave S-band structure. Thus, for cw operation and a ΔP reduction of 20, the energy gain V will be reduced by a factor of between 4 and 5. However, by recycling this low energy cw beam several times through the accelerator cavities (by using a simple system of dc bending magnets to return the beam to the accelerator) and by ensuring that the beam enters the accelerator at the correct phase for each recycling orbit, it is possible to increase systematically the beam energy while continuously extracting power from the electromagnetic fields in the RF structure. In choosing a relatively low operating frequency, it is possible during this recycling process to maintain electron bunches of small radial and longitudinal dimensions with respect to the RF wavelength. These small dimensional ratios are essential in satisfying the phase stability requirements of the system.

The above recycling concept is similar in some respects to the microtron²⁴ except that an extended interaction RF structure and several separately energized dc bending magnets are envisioned. Most of the existing beam recirculating systems, using either conventional or race-track²⁵ microtron principles, operate in the pulsed regime; and due to severe limitations imposed by the phase space characteristics of the beam, none of these systems, to the author's knowledge, have demonstrated average beam currents of greater than a few hundred microamperes.

With the recently demonstrated large reduction of transverse and longitudinal phase space²³ at high values of beam current, much greater credibility is now afforded to the success of a low peak field, multiple orbit, recycling cw accelerator. Rigorous analyses based on the use of a multi-cavity standing wave structure operating in a cw regime indicate that, for specific beam optics conditions, several recirculating passes can be confidently predicted at emergent average beam current levels of up to 10 mA.

A further advantage of operating an accelerator in the cw mode is that a simple RF feedback control element can be used continually to monitor and lock the beam to a given output condition. Since the

size and cost of a cw RF transmitter and a simple beam bending system is considerably less than a high power pulsed transmitter, the recycling linear* accelerator offers attractive economic and space saving advantages when compared to a high peak power pulsed linear accelerator.

References

1. Ising, G. (1925). Prinzip einer Methode zur Herstellung von Kanalstrahlen höher Voltzahl. Ark. Mat. Astr. Fys. **18**, No. 30:1-4.
2. Wideröe, R. (1928). Über ein neues Prinzip zur Herstellung höher Spannungen. Arch. Elektrotech. **21**, 387.
3. Sloan, D. H. and Lawrence, E. O. (1931). The production of heavy high speed ions without the use of high voltages. Phys. Rev. **38**, 2021.
4. Beams, J. W. and Snoddy, L. B. (1933). Production of High Velocity Ions and Electrons. Phys. Rev. **44**, 784.
5. Varian, R. H. and Varian, S. (1939). A High Frequency Oscillator and Amplifier. J. Appl. Phys., **10**, 321.
6. Allen, W. D. and Symonds, J. L. (1947). Experiments in multiple-gap linear acceleration of electrons. Proc. Phys. Soc., **59**, 622-629.
7. Fry, D. W., Harvie, R. B. R. S., Mullett, L. B. and Walkinshaw, W. (1947). Travelling wave linear accelerator for electrons. Nature, **160**, 351-353.
8. Kennedy, W. R. (1948). The design and construction of a linear electron accelerator. Ph.D. dissertation, Stanford University.
9. Ramo, S. and Whinnery, J. R. (1953). *Fields and Waves in Modern Radio*, John Wiley and Sons, Inc., New York.
10. Ginzton, E. L. (1957). *Microwave Measurements*, McGraw-Hill, New York.
11. Haimson, J. (1966). Electron bunching in travelling wave linear accelerators. Nucl. Instr. Meth. **39**, No. 1:13-34.
12. Lapostolle, P. M. and Septier, A. L. (1970). *Linear Accelerators*, North-Holland Publishing Co., Amsterdam.
13. Neal, R. B. (1958). Design of linear electron accelerators with beam loading. J. Appl. Phys. **29**, No. 7:1019-1024.
14. Haimson, J. and Brodie, I. (1963). High-current cathode for electron linear accelerator. Nature, **199**, 797.
15. Karzmark, C. J. and Pering, N. C. (1973). Electron linear accelerators for radiation therapy: history, principles and contemporary developments. Phys. Med. Biol., **18**, No. 3:321-354.
16. Haimson, J. (1963). Radiography of large missiles with the linear electron accelerator. Nondestructive Testing, **21**, No. 2:104.
17. Hogg, H. and Lebacqz, J. V. (1970). Radiofrequency problems. In *Linear Accelerators*, ed. Lapostolle, P. M. and Septier, A. L., North-Holland Publishing Co., Amsterdam, p. 330.
18. Jepsen, R. L. (1962). Getter-ion pumps. In the *Encyclopedia of Electronics*, ed. Susskind, G., Reinhold Pub. Corp., New York, pp. 907-909.
19. Haimson, J. and Karzmark, C. J. (1963). A new design 6MeV linear accelerator system for supervoltage radiotherapy. Br. J. Radiol., **36**, 429: 650-659.
20. Hogg, H. and Lebacqz, J. V. *Op. Cit.*, p. 352.
21. Haimson, J. (1970). High Duty Factor Electron Linear Accelerators. In *Linear Accelerators* ed. Lapostolle, P. M. and Septier, A. L., North-Holland Publishing Co., Amsterdam, pp. 415-470.
22. Knapp, E. A., Allison, P. N., Emigh, C. R., Engel, L. N., Potter, J. M. and Schlaer, W. J. (1966). Accelerating Structure Research at Los Alamos. Proc. 1966 Linear Accelerator Conference, Los Alamos. La Report 3609:83.
23. Haimson, J. (1973). Initial Operation of the M.I.T. Electron Linear Accelerator. IEEE Trans. Nucl. Sci., **NS-20**, No. 3:914-918.
24. Kapitza, S. P., Bykov, V. P., and Melekhin, V. N. (1962). An efficient high-current microtron. Sov. Phys.-JETP, **14**, 266.
25. Froelich, H. R. and Brannen, E. (1967). Four-sector racetrack microtron. IEEE Trans. Nucl. Sci., **NS-14**, No. 3:756.

* To the author's knowledge, greater than 98% of the accelerator waveguides placed into service worldwide during the past 20 years remain in operation today, or have been amortised over the lifetime of the facility.

* The beam recycling microwave accelerator can be considered another form of linear accelerator since the acceleration process occurs only during the linear portion of the particle trajectory; in the interests of avoiding controversy, however, the term "linear" has been omitted from the title of this Appendix.

High-Voltage Electron Accelerators with Local Biological Shield

A. S. Ivanov

D. V. Efremov Scientific Research Institute of Electrophysical Apparature, Leningrad, USSR.

Abstract: *Basic parameters and construction of high-voltage electron accelerators, developed by D. V. Efremov Scientific Research Institute are presented. Among these the most known is "Electron-III" of serial production.*

Its basic parameters are: an energy of accelerated electrons of 300-700 keV at a beam maximum power of 7 kW. The accelerator is equipped with a local biological shield and is manufactured in two modifications for operation with various-construction transporters.

Recently "Electron-IV" with an electron energy of 300-700 KeV and a beam maximum power of 20 kW has been developed. Unlike "Electron-III", this one has a separately made high-voltage source and electron irradiator. The irradiator is fitted with a local biological shield. On a customer's request each accelerator can be furnished with one, two or three irradiators.

Accelerators of "Electron" type consist of the following main units: a high direct-voltage source (transformer with rectifier elements, incorporated between sections of a high-voltage winding); an electron source with a tungsten or lanthanum hexaboride cathode, a frequently-sectional accelerating tube, an electron beam scanning system of electromagnetic type, a vacuum system, control interlock and signal systems. Accelerator constructions are made with regard to their location at industrial enterprises.

At present there is a large number of radiation-chemical and other processes using accelerated electrons, which may be successfully realized on the industrial scale, with the electron beam power exceeding 5-10 kW and electron energy of 300-700 keV^{1,2,3,4,5,6}. The most convenient for a number of reasons are electron accelerators with direct beam current, their instantaneous and average radiation power values are equal to each other. Further on the description and main parameters are given of some high-voltage accelerators of this type, which have been recently elaborated in the D. V. Efremov Scientific Research Institute of Electrophysical Apparatus. The accelerators "Electron-III" and "Electron-IIIM" (Figures 1, 2) made it possible to obtain continuous accelerated electron beams with the energy of 300-700 keV and the current up to 10 mA. The parameters of these accelerators, having similar construction⁷, are given in Table 1.

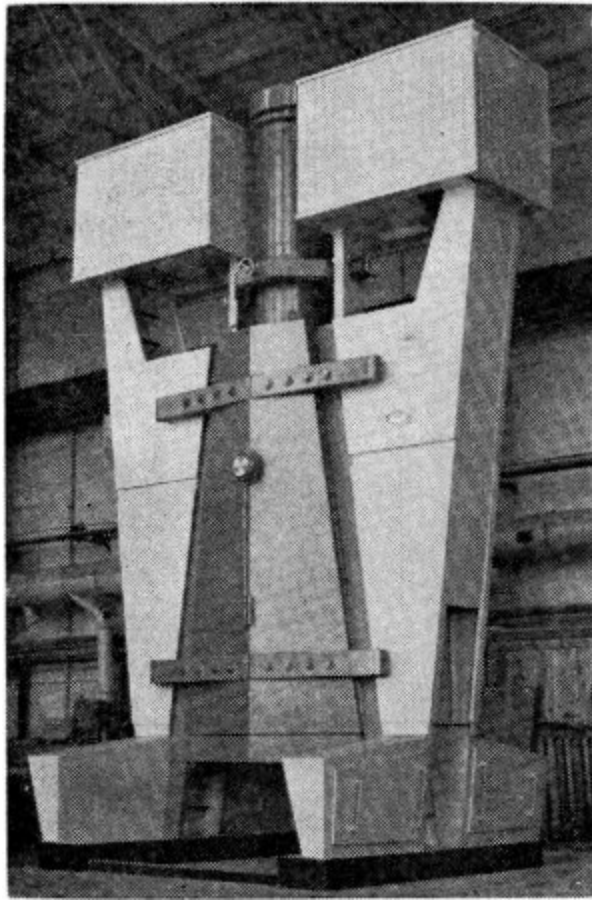

Figure 1. Electron-III.

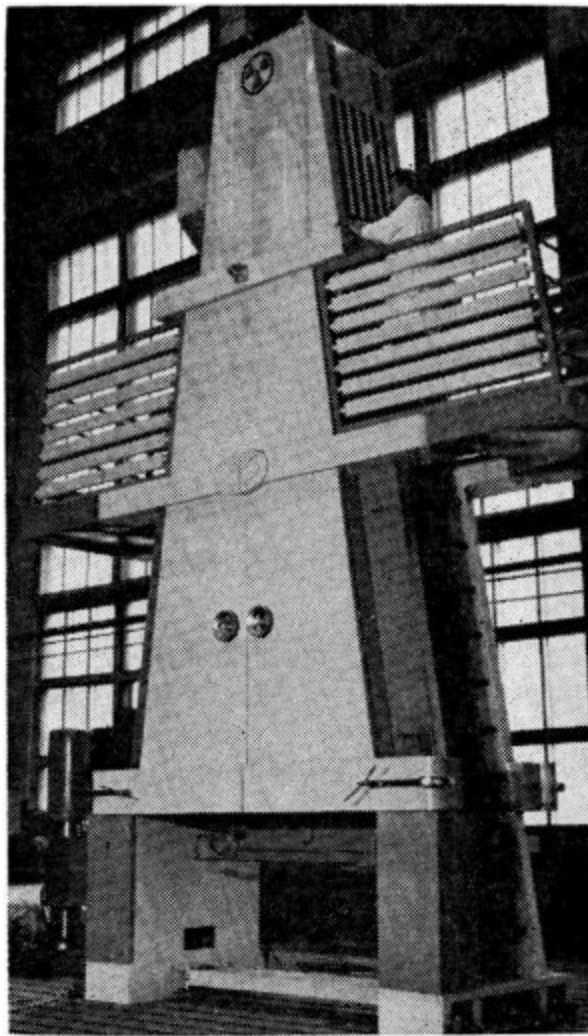

Figure 2. Electron-IIIIM.

Table I

1. Accelerated electron energy	300-700 keV
2. Accelerated electron beam current	0-10 mA
3. Exit window sizes	40 × 1100 mm ²
4. Beam scanning system	electromagnetic with the frequency 50 Hz
5. Current density non-uniformity on the irradiated material surface with the width up to 1 m	not more ± 5%
6. Supply voltage	3 × 380/220 V
7. Maximum power consumption	30 kW
8. Dimensions	1450 × 4800 × 6750 mm
9. Weight	30 t

The accelerator (Figure 3) consists of the multielectrode accelerating tube with the electron gun, mounted on the bottom lid of the metal tank and the high-voltage source with the ballast resistance mounted on the top lid of the same tank. Such an arrangement ensures the convenience of the accelerator assembly and good accelerating tube screening from stray magnetic fields of the high-voltage source. Accelerating elements, subjected to the highest electric potential, are placed in the middle part of the tank.

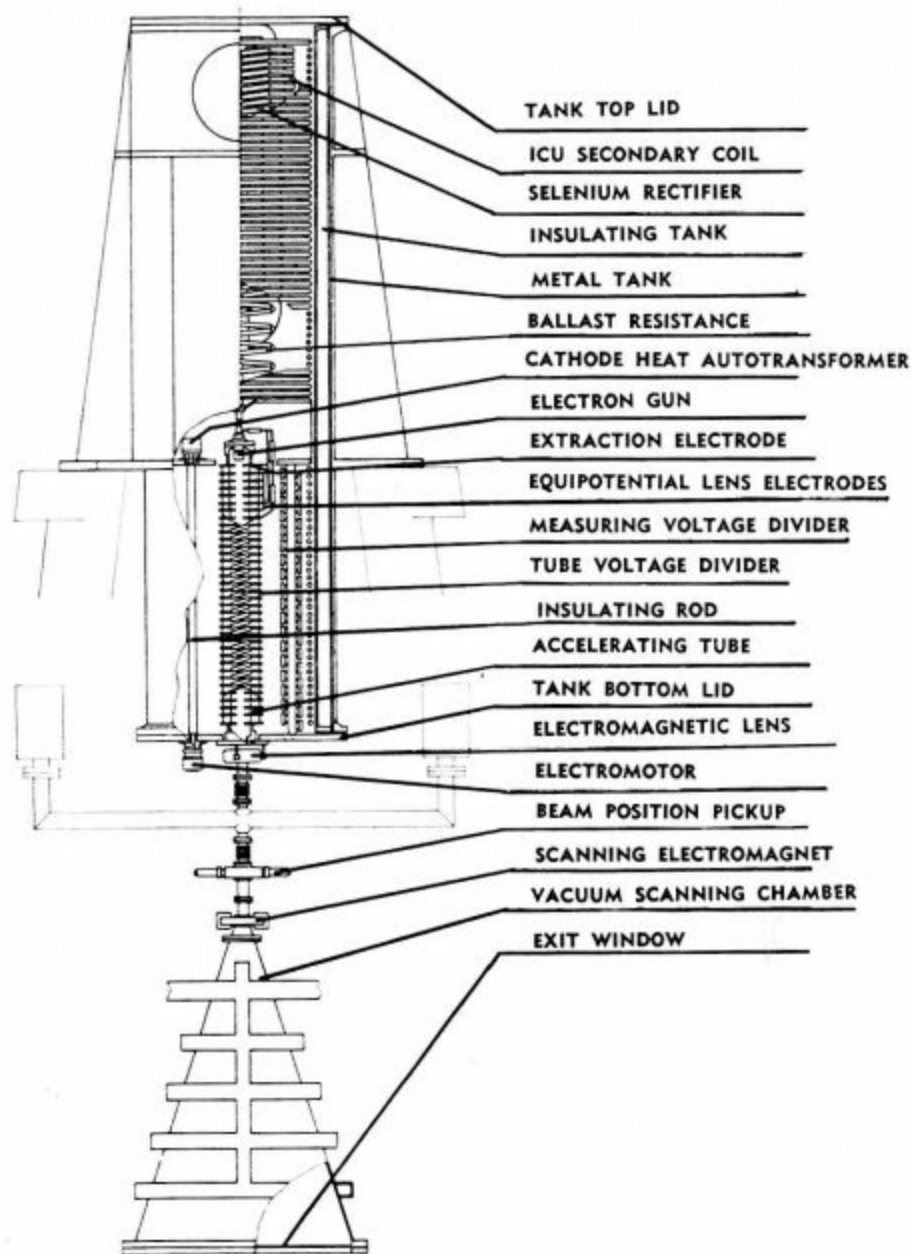

Figure 3. High-voltage accelerator of "Electron" type diagram.

The high-voltage source is made in accordance with a full-wave voltage multiplying circuit having the parallel cascade supply and inductive coupling (ICU)⁸. The secondary winding consists of 200 disk coils, connected one with another by selenium rectifiers. For convenience of assembling and replacement, the secondary coil is divided into 5 interchangeable sections-cassettes. The "O"-shaped magnetic core is made of steel ribbon, and is cooled by the transformer oil. It carries the high-voltage source. The ICU is supplied from a 400 Hz electromachine unit. High-voltage insulation of the ICU and the accelerating tube against the grounded tank is made (as a cylinder) of alternating layers of the polyethylene film and the capacitor paper, which are coiled on the insulating frame. The longitudinal electrical insulation of high-voltage structure elements and the accelerator cooling are effected by the transformer or capacitor oil, filling the metal tank. The high-voltage measurement is carried out by means of the measuring divider.

The filament circuit of the accelerating tube cathode is supplied from a special winding, which is wound on the ICU magnetic core. The filament current and the electron beam current are regulated by the autotransformer which is controlled by the electromotor through the insulating rod. The

electron gun of diode type has the tungsten cathode (in the recent accelerator cathodes are made of the lanthanum hexaboride) which is placed in the accelerating tube field. The high-voltage porcelain accelerating tube insulation rings with the internal diameter of 80 mm, height 12.5 mm and the plane titanium electrodes with the aperture 35 mm are connected by the polyvinylacetate adhesive. In the accelerator is used the electron-optical system which provides at the accelerating tube output the parallel electron beam with the diameter about 15 mm in the energy range 300-700 keV with current changing from 0 up to 10 mA without the additional control. It is achieved because the voltage to all accelerating system elements (the extraction electrode, the single-potential lens electrodes and other tube electrodes) is given from the common resistance divider, the current through which is changing proportionally to the accelerating voltage. At the accelerating tube output is placed the short axi-symmetric electromagnetic lens, focusing the electron beam on the vacuum chamber exit window. The exit window with sizes 40 × 1100 mm is closed by the aluminium foil of 0.08-0.1 mm thickness, which is connected with the flange by metal gaskets. The vacuum chamber flange is cooled by water and the exit window foil is cooled by air. The electromagnet with deflection angle $\pm 18^\circ$, scanning the electron beam with the frequency of 50 Hz is placed at the vacuum chamber input. The current density non-uniformity is not more than $\pm 5\%$ at 40 mm from the foil at the irradiation material width up to 1 m. The operating vacuum in the tube and in the scanning chamber of the accelerator of about 5×10^{-6} torr is maintained by the vacuum system, consisting of forevacuum unit and two electromagnetic-discharge pumps with the total capacity of 200 l/sec. The forevacuum unit which is made as a separate block is switched on for the preliminary pumping-out only, with the accelerator starting after the replacement of vacuum device elements and also after the long interval in the accelerator operation. The control of the accelerator is effected from the control desk. The framework of the accelerator is the local biological shield chamber (L.B.S.)⁹. The use of the local biological shield gives the opportunity to localize the radiation within the limited volume. In this case the dimensions, weight and cost of shielding materials are decreased; the construction becomes simpler and the sizes of the devices, delivering the irradiation objects to the irradiation source are reduced; the removal of toxic products, evolving during radiation processes, is simplified. The accelerator with the L.B.S. may be placed in the usual industrial buildings, while the accelerator without the L.B.S. requires a special building. Figure 4 shows the diagram of "Electron-IIIM" accelerator with the L.B.S. The L.B.S. chamber is a rigid H-shaped steel frame with steel doors. The places of the highest radiation are reinforced by the lead sheets. The door and door-frame joints are carried out by a three stepped labyrinth. The accelerator, enclosed into the earthed metal tank, is placed with the help of the adjusting device on the biological shield chamber. The figure also shows the elements which were mentioned before: vacuum chamber, scanning magnet and high vacuum pump. The scanning chamber is suspended on the biological shield on the control device. This device is used for the adjustment of the scanning chamber input with respect to the actual beam position, which is determined with the help of the thermocouple transducers installed in the chamber. This device is also used to change the distance from the exit window foil up to the irradiated subject by means of branch pipe extenders for the electron-tube channel. The branch pipes are inserted into the breakage between the accelerating tube end and the scanning magnet chamber. In this way it is possible to control the dose rate on the irradiated object with the use of the electron beam scattering on the exit window foil.

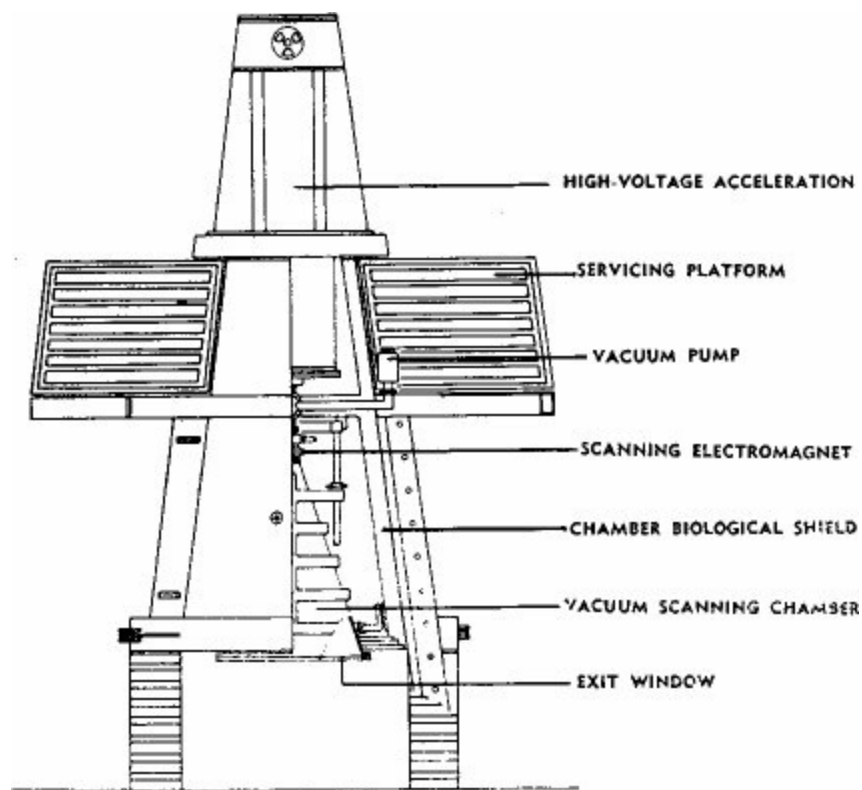

Figure 4. "Electron-IIIM" accelerator diagram.

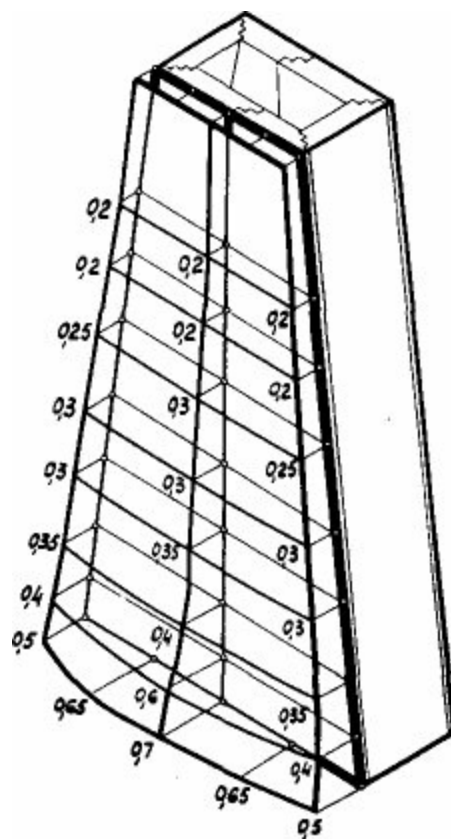

Figure 5. Dose rate distribution at the L.B.S. surface

Availability of the servicing platforms and the doors simplifies the access to all accelerator units and its maintenance. For the connection of the biological shield with the devices delivering materials into the irradiation zone, the lower part of the accelerator shield over the whole contour is made as a three stepped labyrinth connection. In the connection places of some parts the shield chamber is provided

with seals which make it possible, by the proper construction of the delivering device, to create in the irradiation zone by the help of the exhaust and the forced ventilations the required gaseous medium. The biological shield decreases environmental radiation to the standard level. The dose rate values in mcR/sec on the external surface of the biological shield doors of the accelerator, which were measured during the operation are given in the Figure 5. The accelerator is equipped with the block-system which disconnects its power supply when the shield chamber doors are opened or half-closed. Another version of the high voltage electron accelerators which were elaborated in the Scientific Research Institute of the Electrophysical Apparatus is accelerator "Electron-IV" (Figure 6) with the energy of 300-500 keV and beam current up to 20 mA. In contrast to the above mentioned accelerators, the high-voltage source of this accelerator is installed in a separate earthed tank and connected with the accelerating tube block by a high-voltage cable. The accelerator has the scanning vacuum chamber with the exit window of 60×1800 mm. All other elements are similar to the elements described before. The high-voltage source of the "Electron-IV" accelerator is carried out by the full-wave three phase voltage multiplying circuit with the parallel cascade supply and inductive coupling. The primary is connected as a "star". The secondary consists of 60 sections which are connected as a "star" and these "stars" are connected in series with the help of rectifiers. The high voltage source is supplied from an industrial 3 phase 50 Hz mains. The source has 3 sockets for connection of high-voltage cables, it means that we may supply 1,2 or 3 electron irradiators of "Electron-IV" type in single type or in different processes, in such a case the current in all irradiators may be regulated independently.

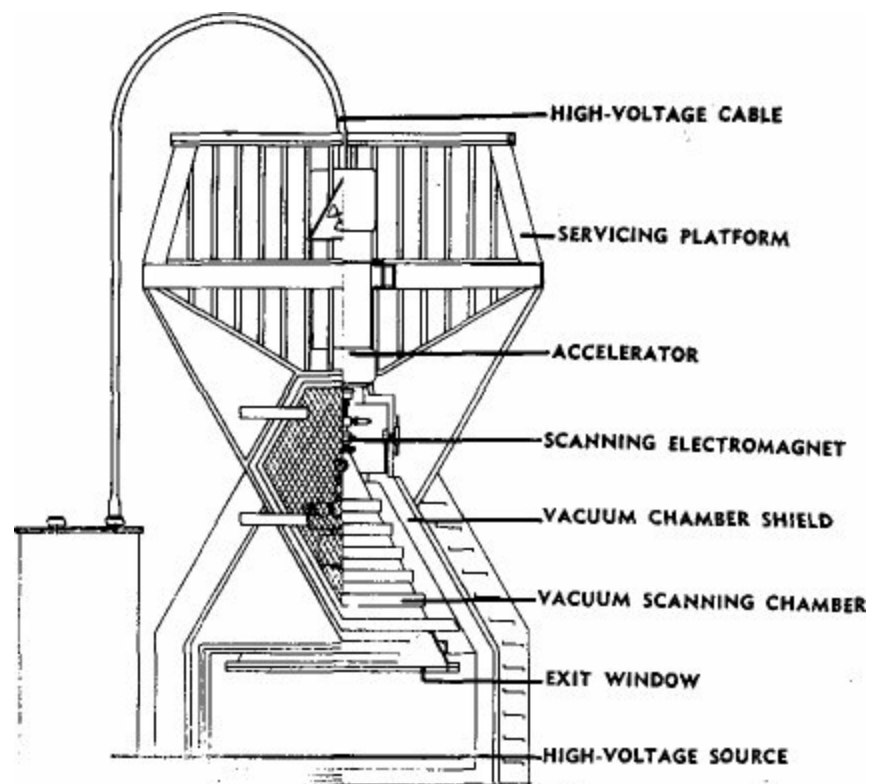

Figure 6. "Electron-IV" accelerator diagram.

All the irradiators may be used in one process, in this case electron energy is regulated on all tubes at the same time in the limits from 300 up to 500 keV. The beam current may be adjusted in every tube independently in the range from 1 up to 20 mA. The maximum current, consumed by all accelerating tubes from the supply source is 40 mA. In this way the material, which moves on the conveyor with the constant speed, may obtain 3 doses of irradiation in the required order.

References

1. A. H. Breger. *Nuclear radiation sources and their application in radiation-chemical processes*. M., Viniti, 1960.
2. A. H. Breger et al. *Principles of construction of radiation-chemical apparatus*. M., Atomizdat, 1967.
3. V. V. Akulov et al. Experimental-industrial radiation-chemical installation with a local biological shield for production of flexible materials. Report at All-Union scientific-engineering meeting on application of accelerators in industry and medicine. L., 1971.
4. *Radiation Chemistry*. Proc. of All-Union scientific-engineering conference "20 years of production and application of isotopes and nuclear irradiation in the USSR industry". Atomizdat, 1972.
5. Yu. D. Kozlov et al. Electron accelerators in radiation chemistry. Report at All-Union seminar "Application of accelerators in radiation chemistry". M., 1973.
6. Shiryayeva et al. Radiation cure of varnished coating by means of accelerated electrons. Report at All-Union seminar "Application of accelerators in radiation chemistry". M., 1973.
7. V. A. Glukhikh. Application of charged particle accelerators in industry and medicine. Reprint P-0165. L., Sreia, 1972.
8. V. V. Akulov et al. Cascade voltage multipliers with an inductive coupling and their application in electrophysical equipment. Electrophysical equipment and electric insulation. M., "Energy", 1970.
9. V. V. Akulov et al. Construction of an electron accelerator with a local biological shield. Report at All-Union seminar "Application of accelerators in radiation Chemistry". M., 1973.

DC Accelerators

W. J. Ramler

Radiation Polymer Co., PPG Industries, Plainfield, Illinois, USA.

The following review relates to a class of accelerators which utilize a non-varying (dc) high voltage to achieve the potential drop necessary for particle acceleration. These accelerators divide into two distinct energy groups with the line of division being about 300 keV. Technology developments will be discussed, including the new generation of machines.

Introduction

In the consideration of an accelerator, either as a tool of investigation or for industrial use, the required characteristics must be established by the user. Beam characteristics, i.e., type of projectile, energy, intensity, and dose rate are always of prime consideration, but other features such as reliability of operation, integrity of construction, operations/capital costs, and physical details must not be overlooked. If the need is one of investigation, then flexibility in beam characteristics is desirable and should include a range of operation for both energy and current, repeatability of preset conditions, possibly the capability to pulse the beam, and even change projectiles, i.e., from electrons to heavier masses for greater dose-rate effects. Flexibility, of course, adds to the complexity and cost of the system, but if the need is industrial, then the accelerator can be tailored to a maximum output of product thereby minimizing both operating and capital costs.

The following will attempt to bring present and possible future capabilities into focus and leave the user with the decision as to his choice.

Accelerator Subsystems

The terminal power supply is one of five basic subsystems that compose an accelerator. In the broadest sense, the others are source, acceleration section, vacuum, and output window. All must be considered in relating to the desirability of that particular accelerator to adequately perform as a tool of investigation or of production. As each type of accelerator is considered, these subsystems will be discussed if uniqueness exists.

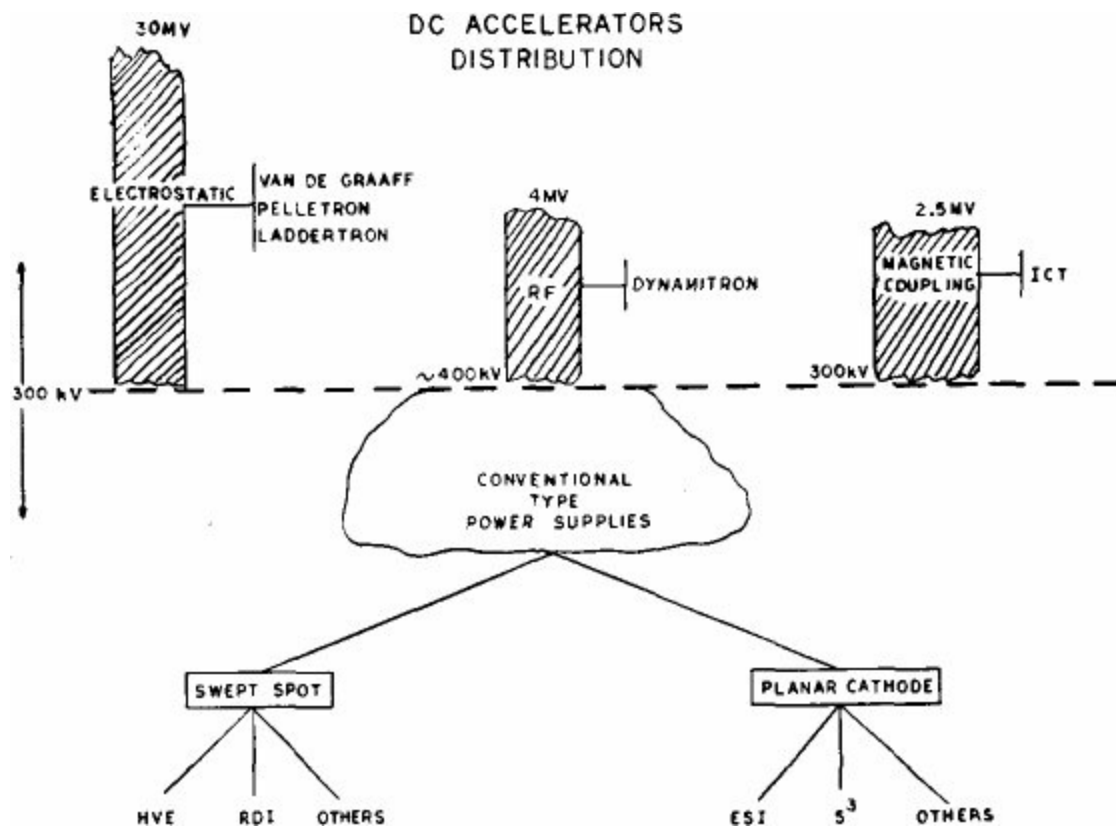

Figure 1. Descriptive grouping of dc accelerators.

Grouping of Accelerators

Figure 1 illustrates a descriptive grouping of dc accelerators by type of power supply, i.e., the method by which energy is transformed from the power line to the terminal of the machine. High potential (30 MV) machines are of a low current (mA) capability and are represented by the electrostatic class. Medium potential (4 MV) machines, modestly high current (20 to 100 mA), are in two groups: rf and magnetically-coupled. Low potential (≤ 300 kV) machines, high current (100 mA), are grouped into the category of conventional-type power supplies with an insulating medium of either oil or pressurized gas. These supplies are also magnetically-coupled, but the number of voltage-rectifying stages are less. As such, the liberty has been taken to deviate from the absolute and class this group as "conventional." Because of the general familiarity with such low voltage supplies, the reader must not overlook possible points of technical uniqueness.

High Potential Accelerators

One of the prime advantages of the electrostatic generator is its capability to provide a very high and stable voltage at the terminal, but it is inherently a low current device because of the various limitations imposed by terminal charging.

Over the years, one of its prime attributes has been simplicity, as evidenced by the wide research and industrial usage of the Van de Graaff. With the advent of the tandem concept by High Voltage Engineering sophisticated design techniques were gradually applied, and as a result a better understanding has been developed of the Van de Graaff-type machine. Further engineering endeavors at many laboratories were stimulated by the need for higher energies, precise beam characteristics, and

heavy ions, which in turn, has enabled the designer to relate to in-depth design of the accelerator subsystems.

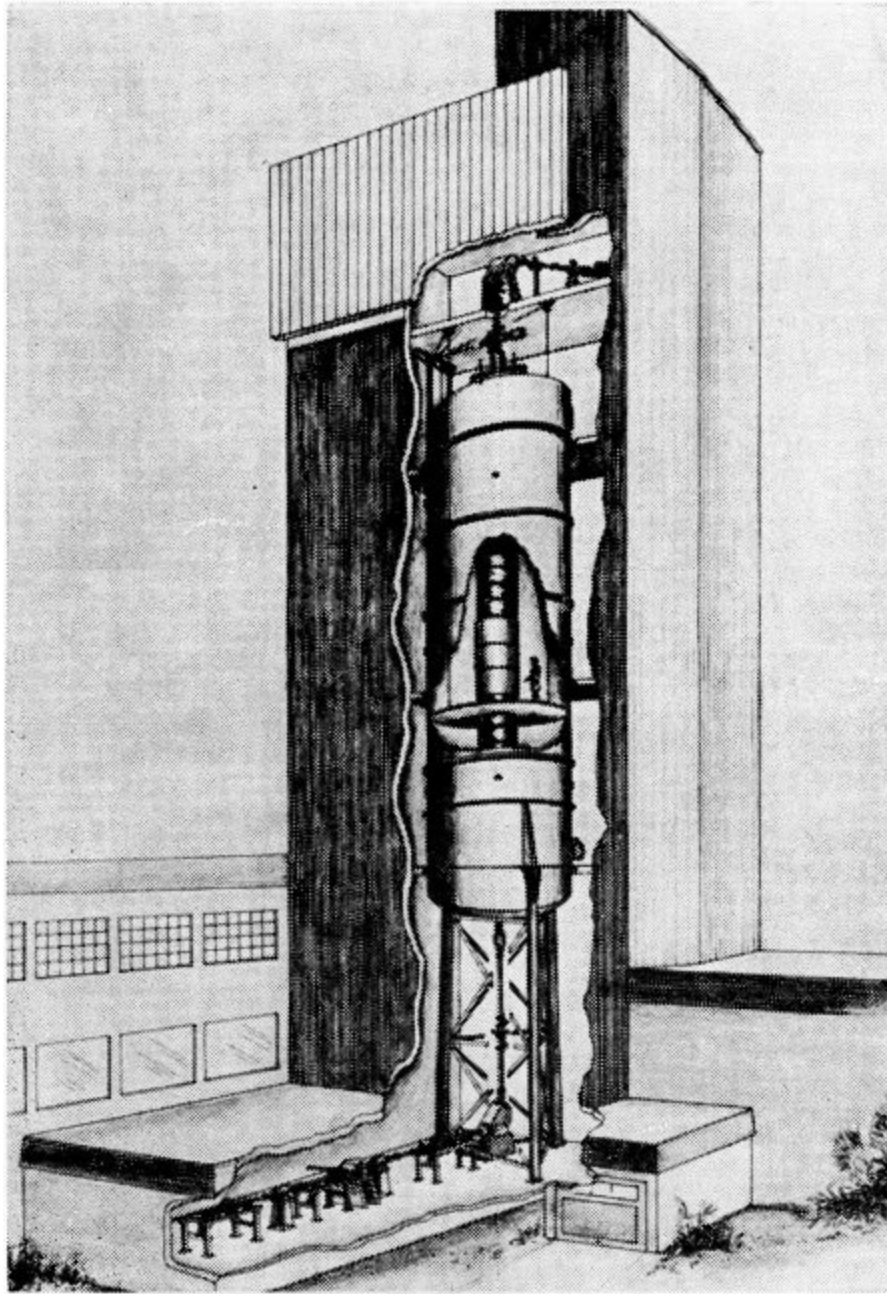

Figure 2. Pelletron™, vertical mounting.

Pelletron™

The Pelletron™ accelerator¹ is a typical example of new technology. Some of the interesting concepts of this system are a unique technique of terminal charging, all metal-ceramic acceleration tubes, and a truly modular type construction. These machines are being very favorably accepted, as evidenced by the installations, the number in production, and the conversion of existing machines. Pelletrons™ range in size from 0.3 MV to 14 MV with designs for 20 and even 30 MV being considered as practical for the future. Typically these accelerators are vertical in mounting (see Figure 2); lower potential machines, such as 6 MV, have been horizontally constructed.

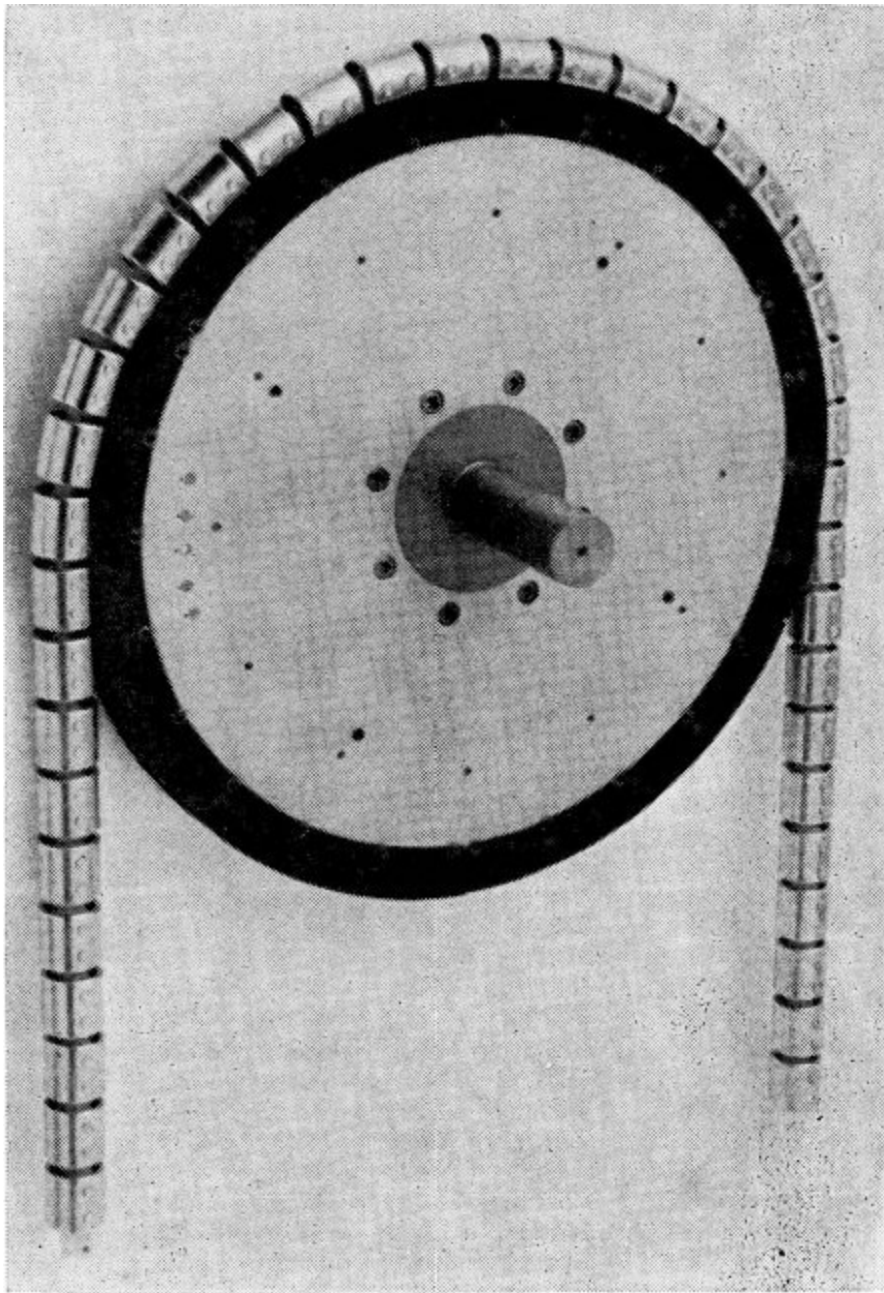

Figure 3. Pelletron™, charging chain.

Terminal charging, i.e., conveying of electrical charge, has been an inherent problem with the conventional belt system. Electrical and mechanical instabilities have been prevalent along with relatively short-lived belt life and the voltage holding instabilities introduced by the dust from the belt. Such problems have been overcome by the Pelletron™ by the use of a charging chain (Figure 3) consisting of metal cylinders joined by links of solid insulating plastic with the gaps between the metal cylinders acting as spark gaps. The metal cylinders are typically about 3.18 cm in diameter. Reliable operation at $150 \mu\text{A}/\text{chain}$ is achieved and mechanical wear is not evident after 20,000 hours or more of operation². The use of multiple (parallel) chains proportionally increases the current capability of the accelerator.

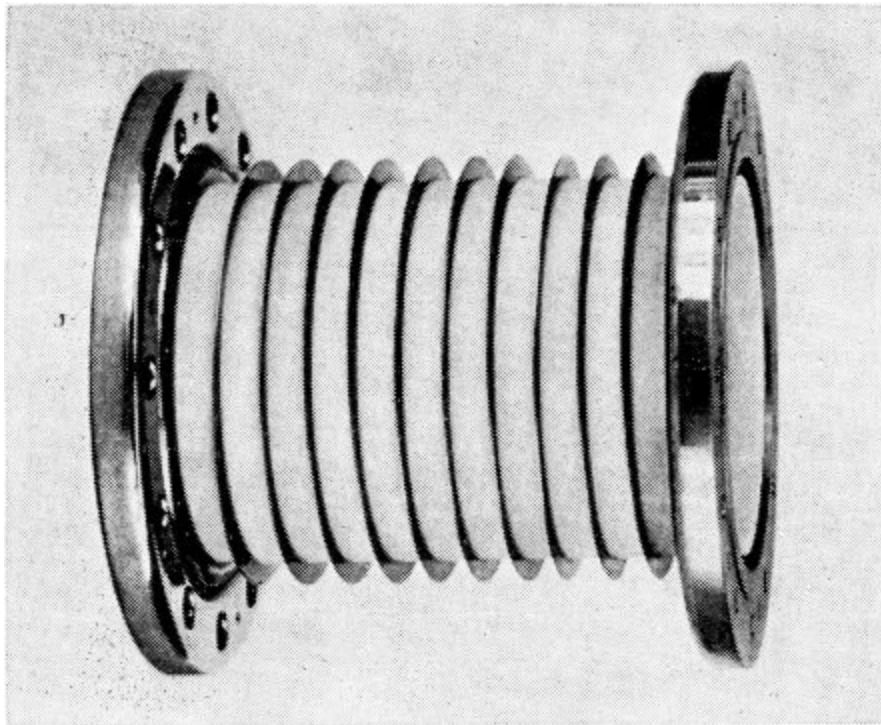

Figure 4. Pelletron™, acceleration tube module.

The accelerating-tube section consists of alumina ceramic rings bonded to titanium metal, thereby eliminating the use of organic materials. A total tube is a composite of these modular sections (Figure 4). Sections are bolted together and sealing is achieved by the use of an aluminum gasket. Operating gradients are about 1.6 MV/m. To provide design flexibility and ease of maintenance, all inner electrodes are removable. An assembled tube can be baked in place, assuring a relatively clean vacuum system. In turn, acceleration stability and reliability of operation are improved. Vacuum cleanliness is required in the acceleration of heavy ions to minimize the phenomena of charge exchange. Requirements for electrons are not as severe, but a high and clean vacuum is a firm step in establishing the operating integrity of the accelerator.

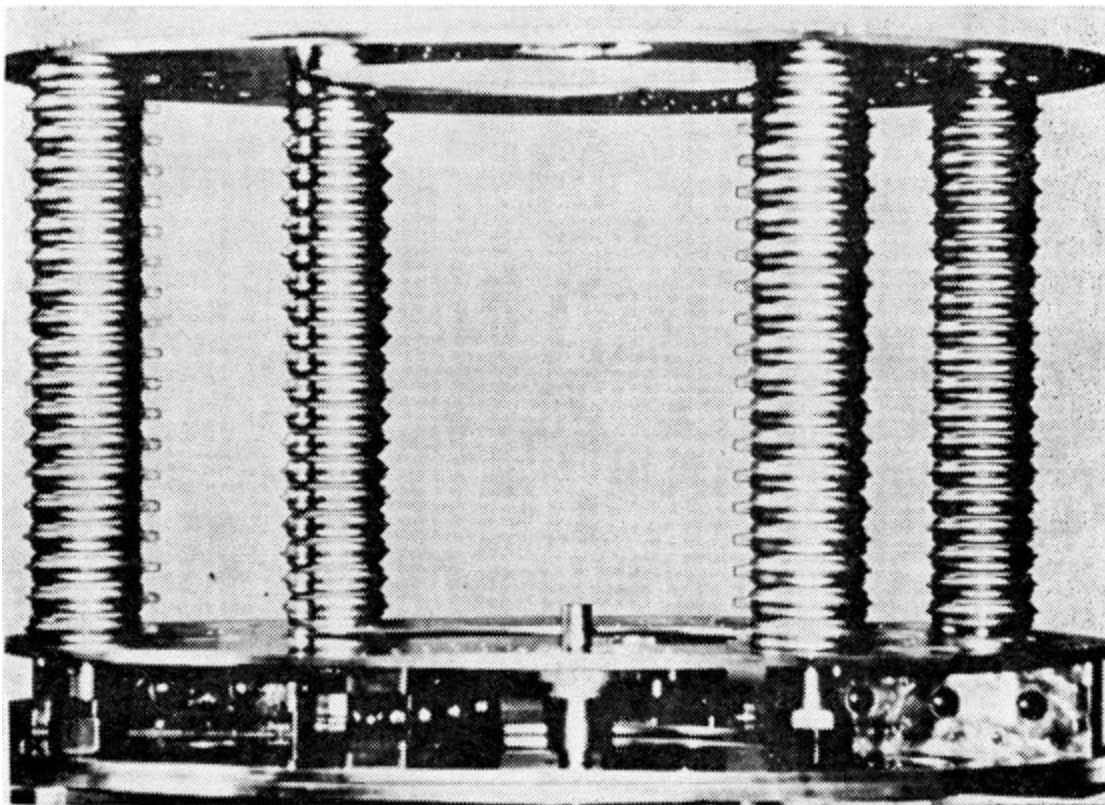

Figure 5. Pelletron™, support column module.

The column structure through which the acceleration tube centrally passes is also of a modular construction. A 1-MV/module design is used with each module (Figure 5) consisting of two cast aluminum junction plates separated by four posts of alumina ceramic bonded to titanium metal. Toroidal spark gaps are inherent to the construction of each post in order to minimize the possibility of damage from surges of voltage. Assembled modules or sub-components of the module are interchangeable providing ideal flexibility for design, assembly, and maintenance.

The features of the Pelletron™ are indeed interesting and should prove to be quite valuable in providing reliable performance. Terminal voltages greater than the present design of 20 MV should indeed be feasible. Current capabilities of the charging system are somewhat low, but multiple chain operation, such as 3 to 5 chains, is possible thereby raising the current capability to about 0.75 mA. Work is now being conducted to increase ($< 150 \mu\text{A}$) the charge carrying capability of the Pelletron™ chain.

Laddertron™

The Laddertron™ accelerator, a vertical, mounted electrostatic tandem Van de Graaff, is now under study and design at the Daresbury Laboratory, Cheshire, England. Terminal voltage design goal is 30 MV. It is proposed that terminal charging, like the Pelletron™, be accomplished by a chain device, but a double structure with a mechanical coupling between sides to give it a ladder appearance, hence Laddertron™. Current capability of this chain is reported to be $550 \mu\text{A}$. Preliminary details of this project are set forth in Reference 3.

For the future, it is of interest to note the reported⁴ collaboration between High Voltage Engineering and the Science Research Council of Great Britain relating to the accelerator endeavors of Daresbury.

Van de Graaff accelerators continue to be required for both industry and the laboratory. Double belt charging is now available with the current rating of the 3 MV machine now being 3 mA. Higher voltage terminals are available as evidenced by the testing of the XTU Heavy Ion Tandem™ accelerator⁴ to a terminal voltage as high as 16 MV.

As previously mentioned, the collaboration with the Daresbury Laboratory will be of interest for the future.

Medium Potential Accelerators

Medium potential machines such as 4 MV or less with modestly high current (20 to 100 mA) are energized by either radio-frequency (rf) or magnetically-coupled power supplies.

RF

DC accelerators utilizing a rf power supply are best represented by the Dynamitron™ (ref. 5) principle which in simplicity consists of a high frequency voltage generator capacitively coupled to a parallel-fed cascaded (N stages) arrangement (Figure 6) of rectifiers. In general these accelerators represent an operational energy range from about 4 to 0.4 MV for either electrons or positive ions. Tandem Dynamitrons™ as high as 4.5 MV (terminal) have been constructed. Rated current output for electrons is typically 50 mA with a twofold increase being projected for the immediate future.

DYNAMITRON POWER SUPPLY SCHEMATIC

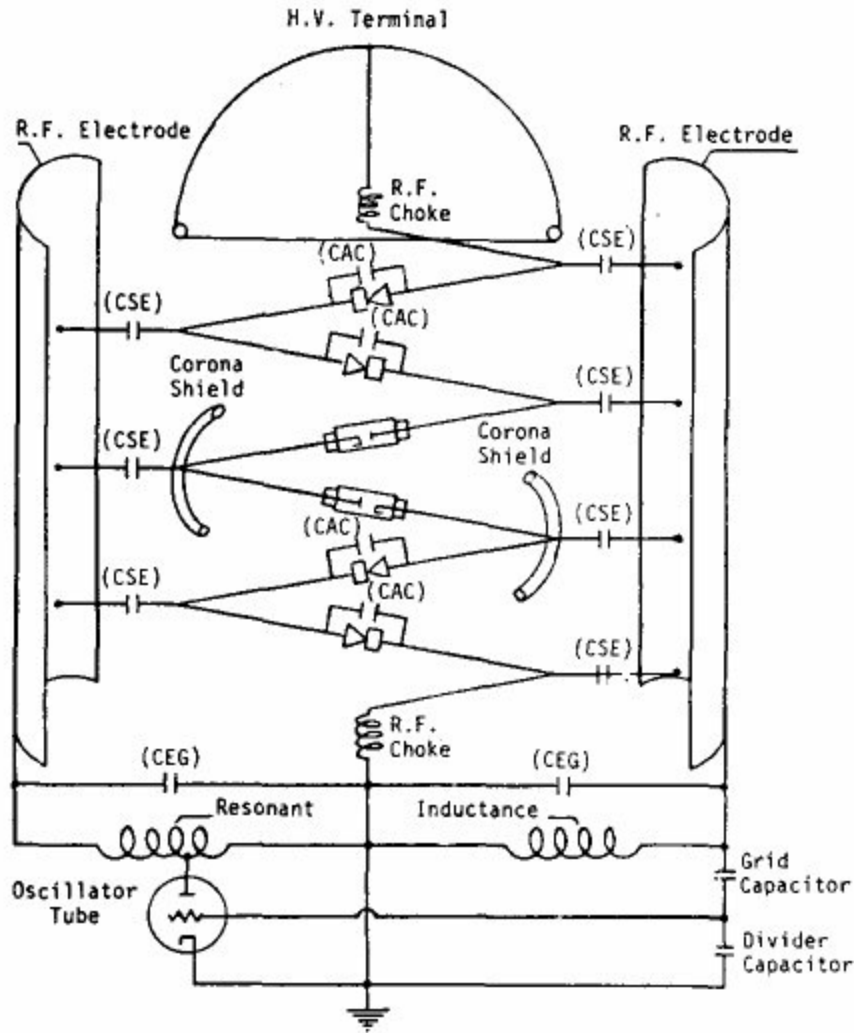

**Key: CSE = Shield to Electrode
CAC = Anode to Cathode
CEG = Electrode to Grid**

Figure 6. Dynamitron™, schematic of rf system.

The Dynamitron™ principle, including both the rf and paralleled cascade rectifier system, is indeed interesting and is an excellent method of transforming large amounts of energy to the acceleration system. Unlike the conventional Cockcroft-Walton in which the internal impedance increases as the cube of the number of rectifier stages, the impedance varies only as the first power, and as such, a greater number of rectifying stages can be employed to achieve a higher cascaded voltage. Also, lower internal impedance is attractive because it is more conducive to achieving a greater magnitude of beam for less energy consumed, i.e., a greater conversion efficiency which will ultimately relate to a lower capital cost per beam kW.

The “now” generation of Dynamitrons™ employ a design which results in a dc potential of 50 kV per stage of rectification. Figure 7 tabulates the rated output current now available over the range of 0.4 to 4 MV. Considerable experience exists with operational levels of 100 mA at 0.5 MV and modest experience⁶ for 1.5 and 3.0 MV at both 25 and 50 mA. A higher output, 100 mA, is indeed feasible since the 50 mA level is achieved with only one rectifier leg. Doubling the output will be accomplished by the use of two such legs. The rf system as now in construction will adequately support the increase⁶.

Typical output current RF dynamitron
(Radiation Dynamics Inc.)

Energy (MeV)	Output (mA)	Output Beam Power (kW)
0.4	100	40
0.5	100	50
0.75	100	75
1.0	50	50
1.5	50	50
2.0	50	100
3.0	50	150
4.0	25	100

Figure 7. Dynamitron™, rated output current.

Now, does this machine provide flexibility in beam characteristics? Yes, both the energy of the beam and the magnitude of the current can be varied. An energy variation of about 2 to 1 can be achieved. An operating current range of about 100 to 1 can be readily achieved with the lower limit being established by the thermal stability of the source. Over this range, beam size will remain about the same with the containment diameter for 90% of the beam being about 1.2 cm.

Efficiency of energy conversion will vary and will depend upon the maximum voltage design of the terminal: about 70% for 0.5 MV, 65% for 1 MV, and 40% for 3 MV. The lower efficiency of the 3 MV design illustrates the effect of cascading rectifiers.

New technology has been brought into the design of these accelerators with specific attention being focused on industrial reliability, including ruggedness of design, ease of maintenance, and lower capital cost. Specifically, solid-state components are now being used throughout the rectifier and the oscillator system. The old toroidal tank circuit coil has been replaced by a linear solenoidal coil which is rugged and “clean” in appearance; by this change alone, overall efficiency of the system was typically raised from about 50 to 65% (1 MV). Spark protection has also been improved and reports from the field⁷ indicate that the acceleration system is now more self-healing. The scan system is essentially unchanged, but the window seal has been changed from a rubber “O” ring to one of gold. Turbomolecular pumps are now being used.

Capital costs have been improved when one relates to beam power. Figure 8 illustrates the cost reduction trend that has occurred with the 3 MV accelerator.

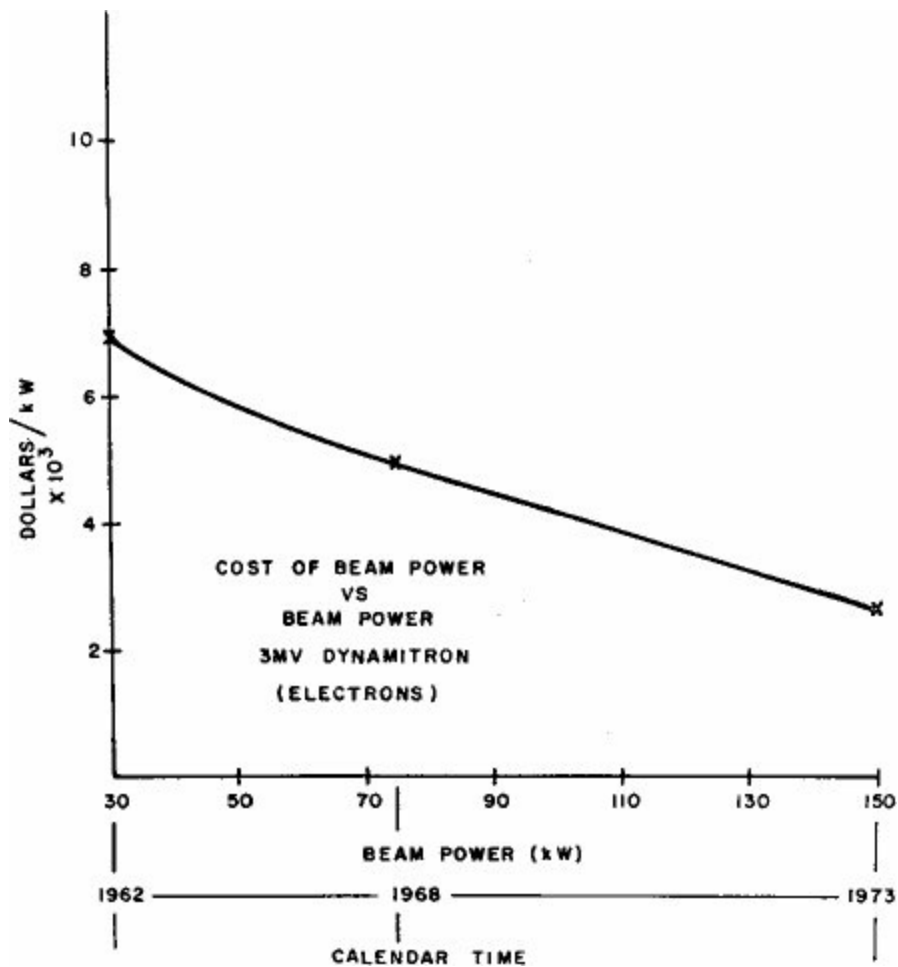

Figure 8. Dynamitron™, cost trend of beam power at 3 MV.

Magnetically-Coupled

An accelerator system utilizing a magnetically-coupled (cascaded rectifier) power supply is best represented by the principle of the insulated core transformer (ICT)⁸. Energy is coupled from the power line to a specially designed magnetic core system. The magnetic circuit is composed of three separate iron columns coupled together at the bottom and top by an iron yoke. The flux loop for each column consists of a series of stacked iron cores each insulated from each other with a stage of rectification coupled to each of these individual cores (see Figure 9). The efficiency of energy transfer relates to both iron loss and the coupling coefficient of the system. Two sizes of iron cores are now considered to be standard, the 15-in. diameter for high beam power and the 7-in. for more modest requirements.

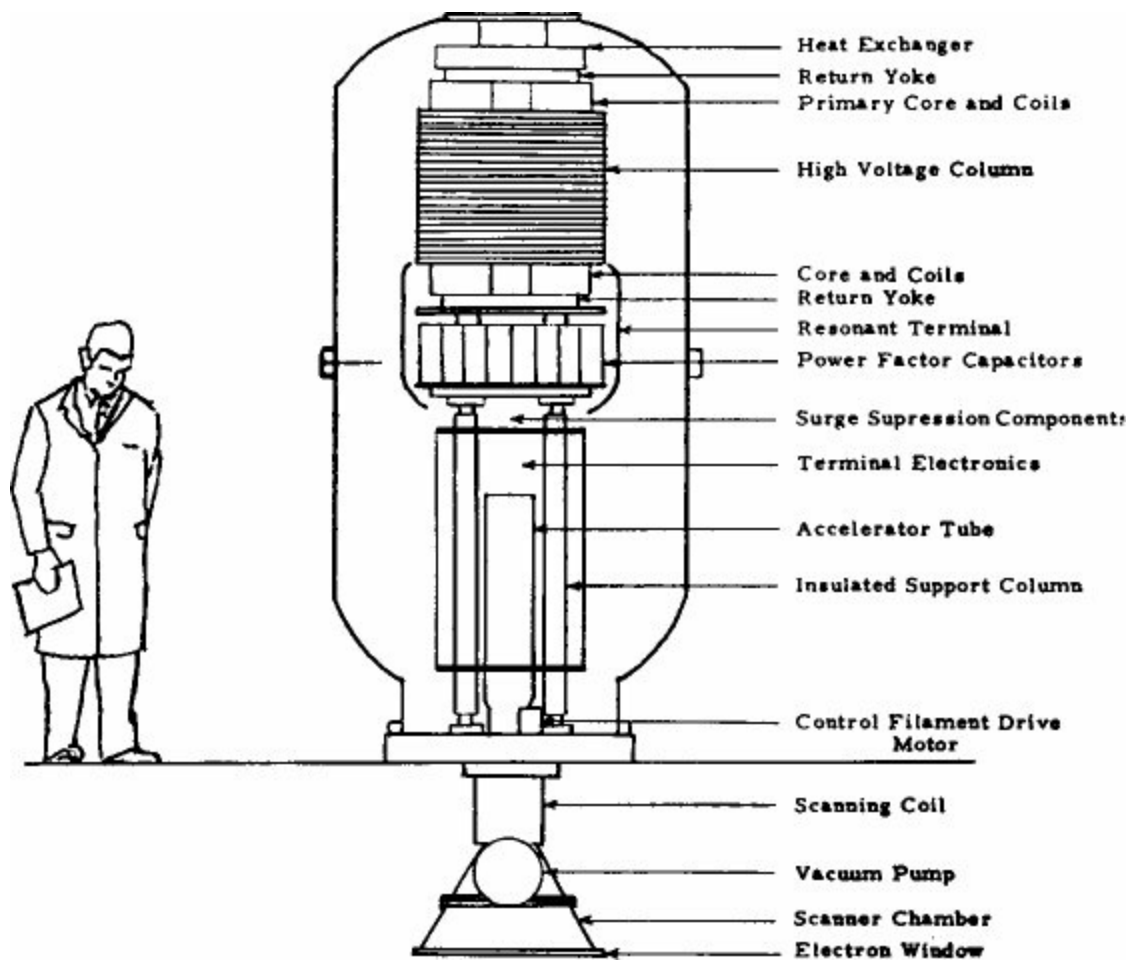

Figure 9. ICT, outline schematic, 1-MeV electrons.

A dc potential of about 50 kV is provided by each stage of rectification. The entire supply, iron and stages of rectification, are contained in a pressurized tank (90 psig) of SF₆. Voltage regulation of the design is about 15%.

The accelerator's terminal is directly connected to the ICT for a design of about 0.75 MV and higher; systems of lower potential (< 0.75 MV) are cable connected. High Voltage Engineering is looking towards increasing this limit of 0.75 to 1 MV. Rated current capabilities of the ICT are tabulated in Fig. 10. Design capabilities are about 50% greater than the ratings⁹. Possibly even higher output currents could be achieved but would require increasing the size of the iron core and the cost of the accelerator.

Typical output current insulated core transformer accelerator
(High Voltage Engineering Corporation)

Energy (MeV)	Core Size (In)	Output (mA)	Output Beam Power (kW)
0.3	7	100	30
0.5	7	50	25
0.75	7	25	19
	15	50	37.5
1.0	7	15	15
	15	50	50
2.0	15	20	40

Figure 10. ICT, rated output current.

At this time efficiency of energy conversion, beam power to ac power, is about 60% for the high power energy designs and as great as 70% for the smaller sizes.

Flexibility to achieve a variation in beam characteristics does exist. Both the energy of the beam and the magnitude of the current can be varied. Operating range in energy is about 2 to 1. A current range of about 100 to 1 can be readily achieved. Size of the beam will be about 1.5 cm for 90% containment for the 15-in. core and as small as about 0.3 cm for the 7-in. size.

New ideas and technology have been applied to ICT with the potential per rectifier deck being decreased from about 72 kV to the present level of 50 to 55 kV. Encapsulated rectifier decks are now being used along with quality control in an effort to minimize manufacturing and operational fault within the rectifier chain. Effort continues to provide an "early warning" fault detection system so that the operator will be forewarned of internal problems in the ICT power supply, thereby minimizing catastrophic-type repairs. Stored energy of the system is a factor that can relate to the seriousness of internal faults. Capacitance of the terminal to the tank and within the stack of iron cores is about 125 pF and 1000 pF respectively for the 7-in. core and somewhat greater for the 15-in. size. Of course, this stored energy is important when terminal pulsing the beam. The electronics of the scan system has been improved, solid-state components are now being used, and in general, the layout of the controls, internal wiring, and cabinetry has an excellent appearance. Ion-type pumps continue to be used on the vacuum system.

At this point, the efforts of the Nissin High Voltage Co. of Kyoto, Japan, need to be mentioned. They are now marketing an oil insulated, hermetically sealed, dc power supply for industrial accelerators. Supplies operating at 500 kV and 100 mA have proven to be quite reliable. Units operating at 800 kV and 100 mA are also available and should be considered.

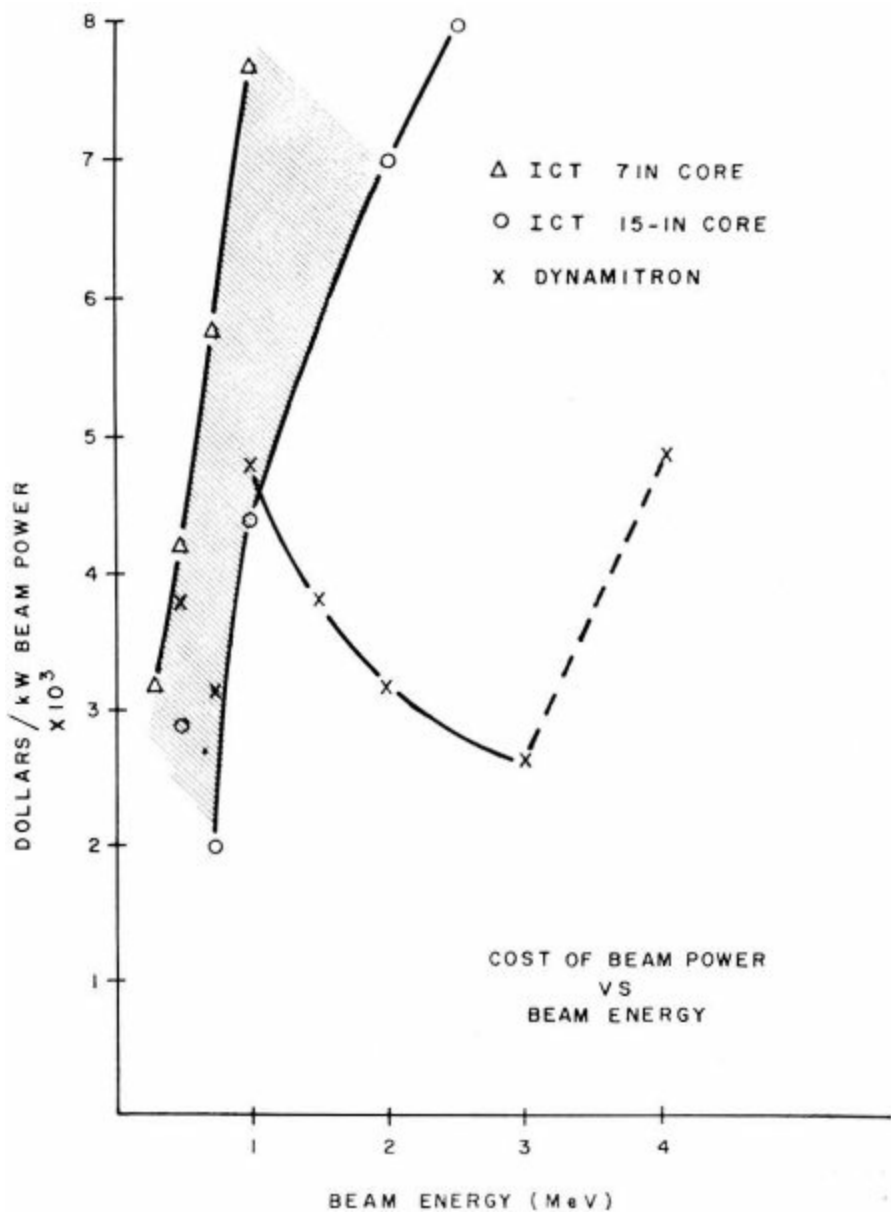

Figure 11. Capital cost/kW of beam power vs beam energy.

Capital Cost Comparison

Capital costs for the rf and magnetically-coupled systems referenced to the Dynamitron™ and ICT respectively can be illustrated in two different ways. Figure 11 relates to the capital cost per kW of beam power and Figure 12 to the capital cost of the accelerator without specific regard to beam power. Both sets of data are of interest and value in establishing an understanding of cost as related to the projected economics of processing a product. For example, as now marketed, and neglecting operating costs, if the intensity of the ICT is adequate, then, this accelerator would contribute less cost per unit of processed product. But, if greater power capabilities are required, then the Dynamitron™ would be less expensive even though the capital cost is greater.

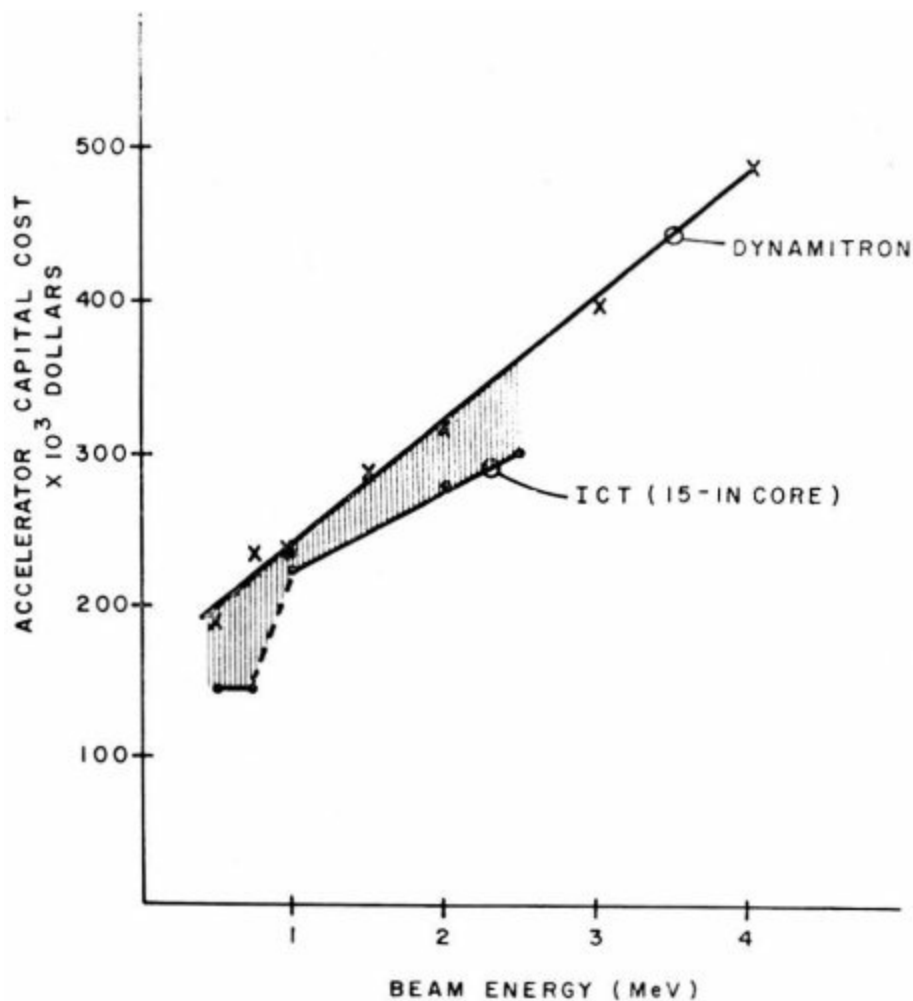

Figure 12. Capital cost vs beam energy.

Low Potential Accelerators

Low potential accelerators, i.e., 300 kV and lower, and high current (100 mA), are generally energized by conventional power supplies. Such supplies employ magnetic-coupling for 1 or 2 stages of voltage rectification; insulating medium is either oil or pressurized gas and the load current capability can exceed a hundred mA. The supply and acceleration sections are usually physically separate with a cable-type connection between the two.

These accelerators can be further classified as to the effective source geometry, i.e., circular or planar. The former requires a beam sweep system and the latter does not.

Circular

Three commercial companies represent the major manufacturing effort of these accelerators, i.e., High Voltage Engineering, Radiation Dynamics, Inc., (Dynacote), and Texas Nuclear, Inc. A current level of about 100 mA is the maximum now available. The thinking appears to follow the 100 mA modular concept, i.e., if a 200 mA installation is required, then, two units each with 100 mA capability would be used.

An operating level of 100 mA and even greater is indeed practical as proven by the 122-cm pilot-production line operating at the Radiation Polymer Company. The 300 keV accelerator (High Voltage Engineering) consistently operates in excess of 100 mA to illustrate process feasibility.

Operation at lower magnitudes of current is also feasible and the energy can indeed be varied. A range of current extending from 0.5 mA or less to 100 mA is practical with the operating range in energy being about a factor of two. The latter is dependent upon the effects of the beam window, i.e., the loss of energy by the electrons and the number captured as well as the scattering effect introduced into the beam; the media between the window and the product must also be considered.

These accelerators, like their higher energy compatriots, employ a beam sweep system to provide uniform distribution of dose over the surface of the product. To accomplish the distribution, the length of the overall accelerator is increased by the addition of a "scan bucket". Indeed, this increases not only the physical size of the accelerator, but, the volume and cost of the shielding. Other factors of consideration are the increased thermal-mechanical stresses that are interjected into the design and operation of the beam window, along with an urgency for a scan system with a high degree of reliability.

Rectangular (Planar Cathodes)

The idea of a planar cathode for industrial processing is not new and in 1968 it was an active situation in the United Kingdom at Tube Investments Ltd¹⁰. Efforts in the USA are now being directed to such a beam geometry. Such structures have been constructed and marketed in a relatively modest range of current. Higher current structures for commercial application are imminent as evidenced by the existing activity in testing of prototypes. Specifically, Energy Sciences Inc. have constructed planar structures as long as 125 cm. Operating units at 10 mA, 50-cm long, have been installed with the 125-cm unit now being tested at about 50 mA. Terminal voltage is about 175 kV. Figure 13 illustrates the conceptual principle of the design. As shown, the cathode projects into the plane of the paper with cylindrical geometry for the grid and the anode. The system is indeed compact as shown by Figure 14 which is the 125-cm structure. With the designed energy range, lead shielding can be very efficiently used. The required shielding can essentially be wrapped around the entire accelerator structure to maintain compactness. The scan system and bucket is eliminated thereby providing a system of completeness and simplicity.

POWER LOSS CONSIDERATIONS

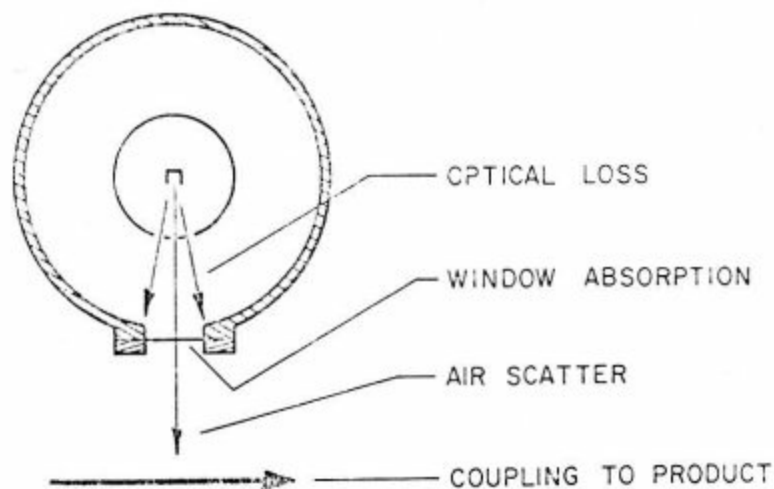

Figure 13. Planar cathode schematic (Energy Science Inc.).
Single user license provided by AIAA. Further copying, networking, and distribution prohibited.

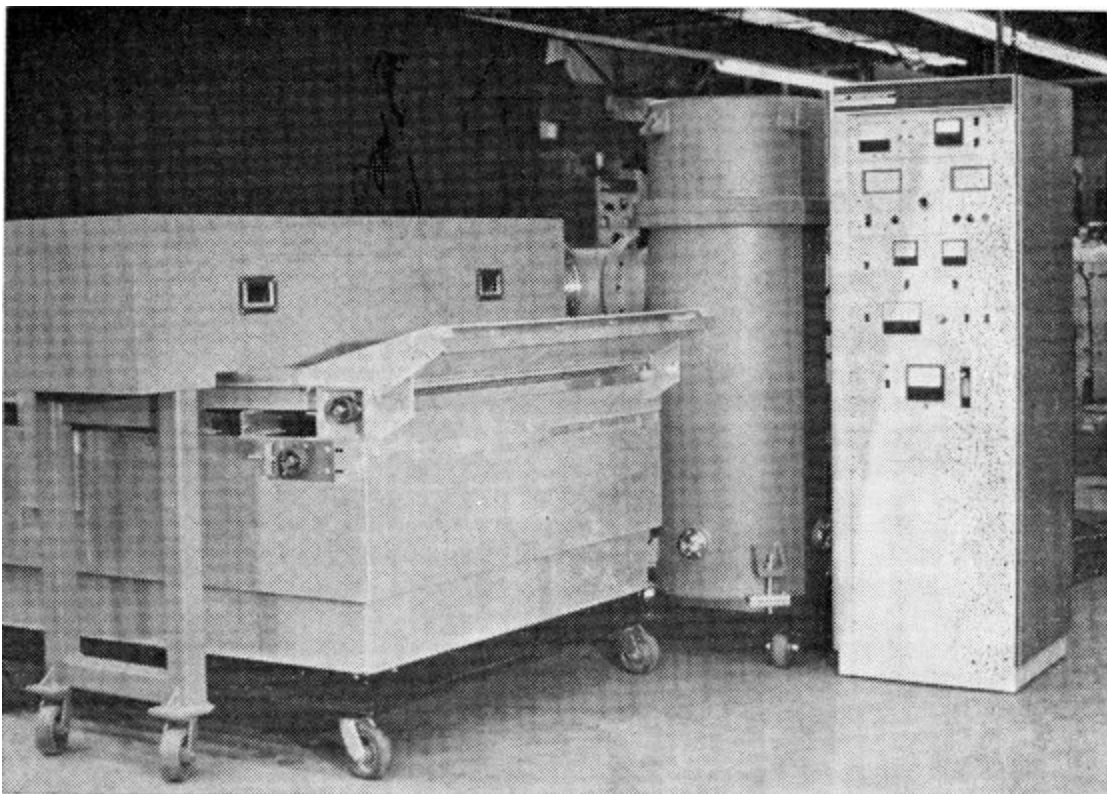

Figure 14. Accelerator assembly for 125 cm beam width (Energy Science Inc.).

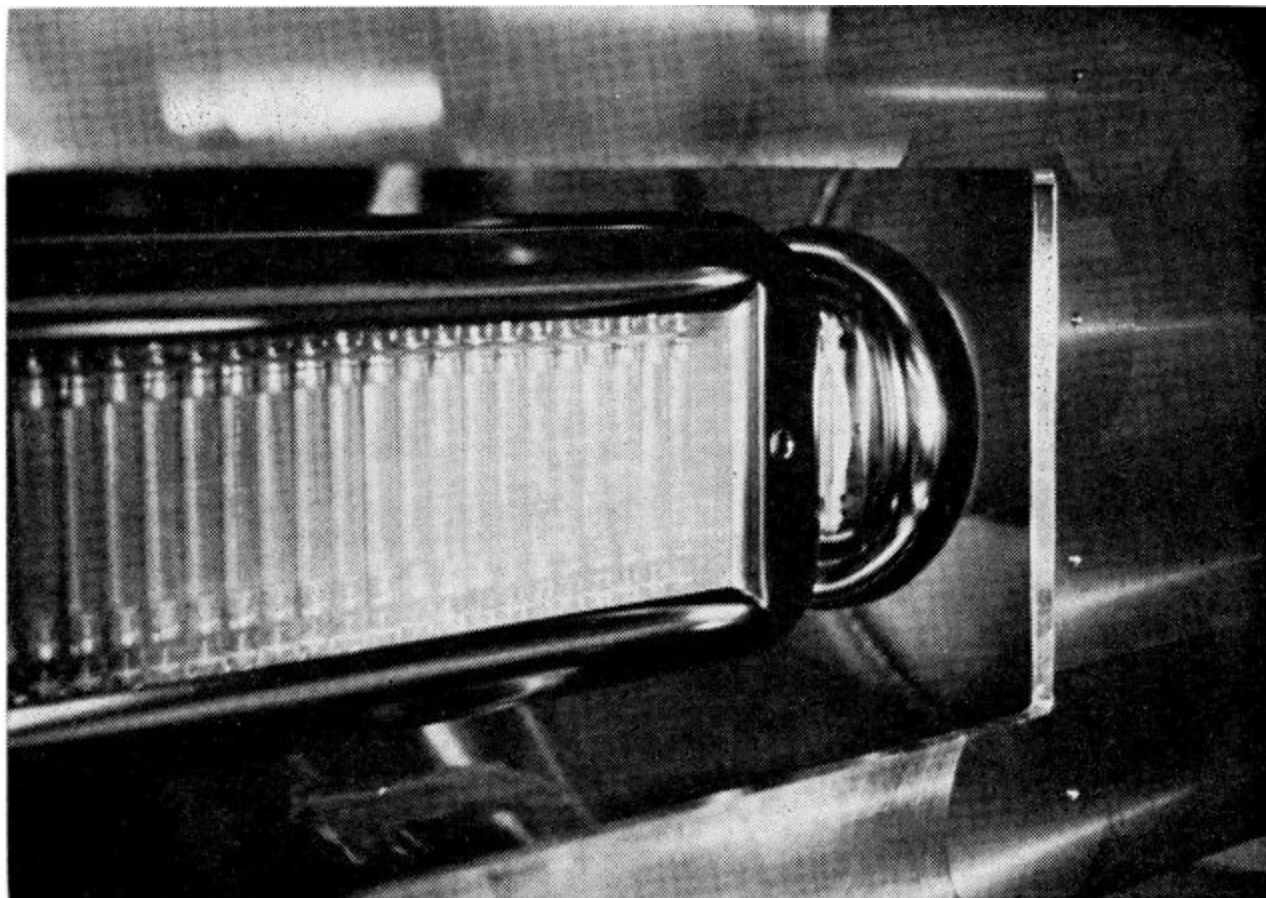

Figure 15. Planar cathode assembly showing concentric filament modules (Systems, Science & Software).

Rapid advances in the technology of planar cathodes are also being made by Systems, Science & Software. They have constructed several accelerator systems for the control of the ionization level of a

laser gas. Essentially these systems are electron accelerators operating with a power supply, acceleration system, planar source, vacuum system, and a window. Terminal voltages ranging as high as 300 kV are used. A prototype accelerator for industrial processing has been constructed with the capability of testing a 165-cm long cathode. Tests have been initiated with a 61-cm cathode. To facilitate testing, the power supply was pulsed to provide an accelerated peak beam current of about 20 A with a time fwhm duration of about 7 μsec . At 1000 pps the time average current would be about 120 mA.

A typical view of their planar cathode is shown in Figure 15. In brief the cathode is a planar array of concentrated cathode-control grid elements. Figure 16 illustrates typical data of surface dose distribution for such geometry. The initial efforts of Systems, Science, and Software are indeed interesting and the results appear to be quite promising.

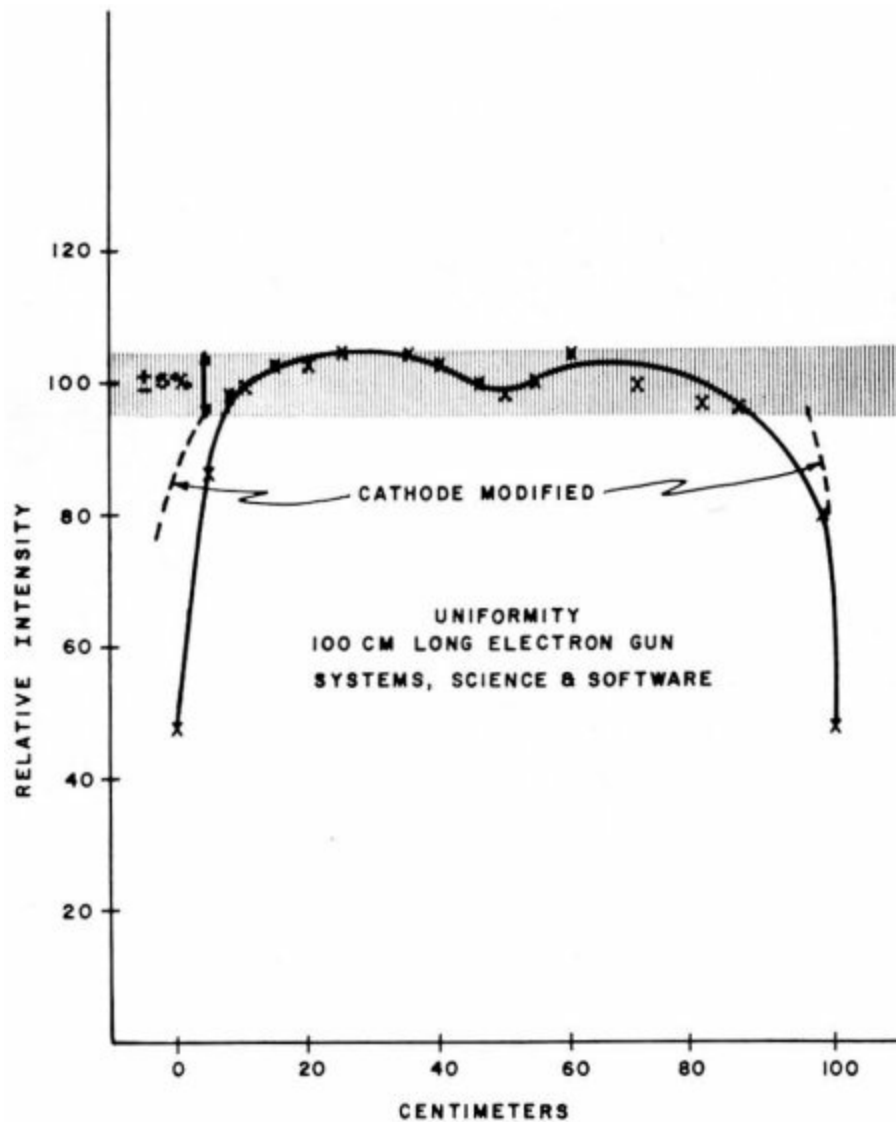

Figure 16. Intensity distribution for a 100-cm long planar cathode for laser ionization (Systems, Science & Software).

Beam Pulsing

Beam pulsing could very well be a very attractive optional feature. Systems relating directly to source (gun) pulsing¹¹ have been in use for many years to develop beam pulses in the nano- and micro-second time domain. Figure 17 illustrates typical pulses that have been obtained from the Argonne National Laboratory Van de Graaff. Pulses of amplitude 5 A are consistently obtained (1 to 100 nsec)

with a rise/decay time of about 0.3 nsec; amplitudes as high as 8 A have been achieved, limited only by the emission capabilities of the cathode. Interpulse current was about 1×10^{-11} A, and the pulse repetition rate was variable from a single-shot operation to 1000 pps. In the use of such an arrangement, the stored energy of the accelerator must be considered as well as the terminal space available to accommodate the hardware. In principle, such pulsing can be achieved with either the ICT or the Dynamitron™.

Pulsing of the planar cathode structure can also be achieved.

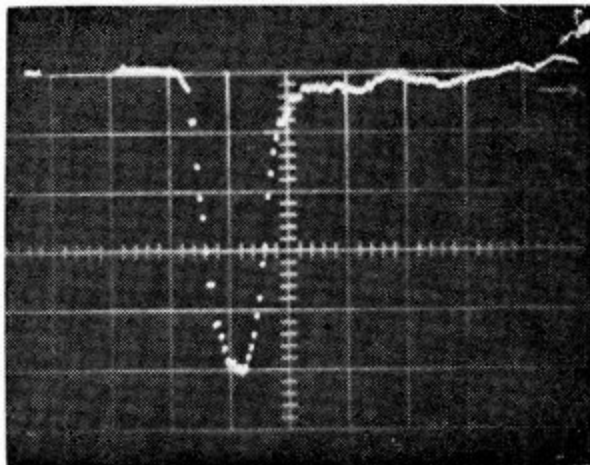

(A)

2A — 1 ns

(400 mA / cm — 1 ns / cm)

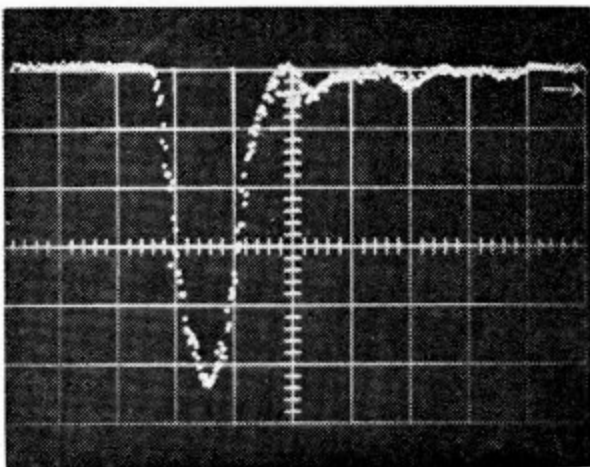

(B)

5 A — 1 ns

(1 A / cm — 1 ns / cm)

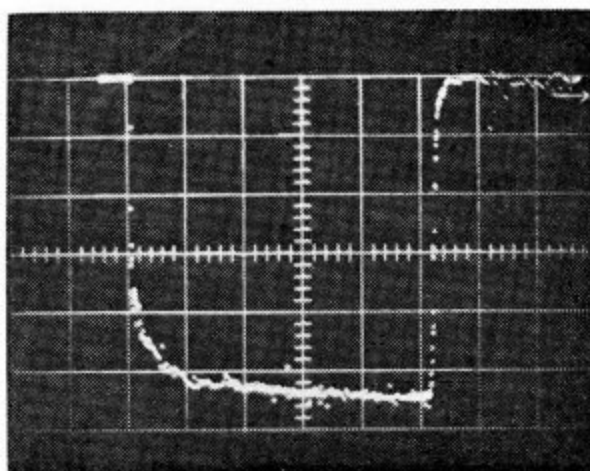

(C)

5A — 100 ns

(1 A / cm — 20 ns / cm)

Figure 17. Beam pulses obtained from a Van de Graaff.

With the advent of high power accelerator operation, 3 MeV-50 mA (150 kW), consideration should once again be given to the use of the accelerator as a source of X-rays (bremsstrahlung). To stimulate such a review, let us perform a series of simple calculations. Assume beam impingement on a thick W target. Then, the X-ray power yield (4π) will be about 10% with about 65% in the forward direction. The forward yield will then be 6.5% and for the subject accelerator, 9.7 kW of X-ray power. If the efficiency of absorption within the product is 30-35%, then the absorbed power will be about 3 kW. With a curie-watt conversion of 68 curies/watt, this would represent 2×10^5 curies for a 100% efficiency of absorption of a cobalt-60 source.

Assuming a 20% absorption efficiency for a cobalt-60 source, the total curies required is then 1×10^6 . At a cost of \$0.45/curie, this source would represent a capital investment of \$450,000. The 3-MeV accelerator costing \$400,000 would indeed be comparable. In addition, the accelerator is indeed a "cleaner" source, but is the high dose rate of the accelerator a problem? From these calculations it would appear the accelerators vs cobalt-60 should again be reviewed!

Conclusions

Recent developments and those now under development will provide interesting possibilities for the present and future. The existing trend by the accelerator manufacturers to provide equipment that will sustain beam characteristics and operation in an industrial environment is most important; this was a problem in the past and for the present continues to require the attention of the user.

Modular construction techniques and other concepts incorporated into the design of the Pelletron™ are refreshing. Possibly the Pelletron™-type acceleration tube should be considered for use with other types of acceleration systems. Effects from radiation damage would be minimized along with the costs of tube replacement and the associated time to effect repairs.

Increased power levels and lower capital costs are always of an interest to the user. In addition, increased beam power brings once again into focus the economics of X-ray production vs the isotope source. Furthermore, irradiation from two sides should again be considered, either by a double-ended type accelerator (source in the center of the two accelerator tube arrangement) for terminal voltages of 0.75 MeV and higher or, for lower voltages, one common power supply and two acceleration sections. With stable beam characteristics, this could indeed be more attractive, especially if the product is a homogeneous medium. The penetration efficiency as related to the single-sided irradiation would be about 2.4 fold greater, and the efficiency of energy absorption would also be enhanced.

The planar cathodes are the interesting development in the low energy domain. Either low or high current structures with uniform intensity distribution appears to be feasible. The low dose rate condition will be attractive and costs, including the housing, should be lower. Hopefully such structures will have energy capabilities of at least 0.7 MeV.

Acknowledgments

I wish to take this opportunity to convey my thanks to the following who so generously answered my questions and contributed their own ideas. Specifically, R. Herb (National Electrostatic Corporation), and his colleagues for the literature and time expended in reviewing the Pelletron™; C.

Hoffman and R. Fernald (High Voltage Engineering) for their time and literature relating to the ICT; S. Nablo (Energy Sciences Inc.) for reprints and photographs of his accelerator system; A. Klein (Systems, Science & Software) and his colleagues for data pertaining to their planar cathode; K. Morganstern (Radiation Dynamics Inc.) for both data and discussions relating to the Dynamitron™; and A. Langsdorf (Argonne National Laboratory) for discussion and reports covering the Dynamitron™. Laddertron™, and general ideas for the future.

References

1. National Electrostatic Corp. (NEC), Middleton, Wisconsin, USA.
2. Herb, R. National Electrostatic Corp., private communication.
3. Science Research Council, Daresbury Nuclear Physics Laboratory, The Design Study for a Nuclear Structure Facility at Daresbury, DNPL/NSF/R4 (1973).
4. High Voltage Engineering Corp., *Newsletter* (Feb. 1974).
5. Radiation Dynamics, Inc., Westbury, Long Island, New York, USA.
6. Morganstern, K. Radiation Dynamics Inc., private communication.
7. Langsdorf, A. Argonne National Laboratory, private communication.
8. High Voltage Engineering Corp., Industrial Division, Burlington, Massachusetts, USA.
9. Fernald, R. High Voltage Engineering Corp., private communication.
10. Davison, W. H. T. Tube Investments Limited, private communication.
11. Ramler, W. J., et al., High Current Pulsed Electron Source, *Nucl. Instr. and Methods* **47**, 23 (1967).

Commercial Units for Radiation Sterilizing Medical Supplies

V. B. Osipov, S. V. Mamiconyan, G. D. Stepanov, Yu. S. Gorbounov, A. A. Koudryavtsev, B. M. Terentyev, I. I. Sarapkin, Yu. I. Saphonov, N. G. Concov, B. M. Vanyushkin, S. Yu. Crylov, E. S. Corzhenevsky, V. M. Levin, V. A. Gloukhikh, B. I. Mountyan

Committee for the Utilization of Atomic Energy, Staromenetnyy, Peteulok, 26, Moscow, ZH-180, USSR.

Abstract: *The preconditions for creating U.S.S.R. industrial radiation units for sterilizing medical supplies are presented in the paper. The principle of operation together with the unit design is described and the main technical and operating characteristics of the developed units with use as a powerful radiation source both the electron accelerator LUE-8/5V and Co⁶⁰ isotope are given.*

Radiation sterilization of medical products (particularly those made of polymer materials) is one of the basic fields to be mastered by radiation technology on an industrial scale¹. At the present stage more than thirty powerful radiation units are use a round the world. In these facilities both electron accelerators and radioisotope gamma-ray sources are used as a powerful source of ionizing radiation. Data presented by E. E. Fowler in his review report at the 4th Geneva Conference are very significant². According to the state of work in the given field it may be said, that on the whole radiation sterilization is not a scientific-engineering problem any longer and now it is in the phase of becoming a field of the medical industry.

Developing and solving this problem in our country started some years ago. The reason for this was the result of home studies which revealed, that radiation sterilization provided:

(1) guaranteed high degree of sterility for various products (including volumetric ones which could not be sterilized when using other known methods).

(2) feasibility of sterilization of plastic materials showing thermal instability and the products made from them of various geometry; safety in use of sterilized products and materials; preservation of the achievable degree of sterility due to the products treatment in hermetically sealed packages of different kinds, which were "transparent" for ionizing radiation in sterilization and "not transparent" for penetration of microorganisms after the sterilization process had been terminated and during the subsequent process of storage; feasibility of making a continuous-production line (an automatic line) of radiation treatment in conditions of the mill production of the packed products:

(3) capability of the method to withstand competition in comparison with other sterilization methods when introducing them in industrial production of some products for medical use.

The discussion on applying the type of sources of ionizing radiation (electron accelerators and radioisotope gamma-ray sources) which had taken place in USSR and abroad did not show up the dominating position of one of the mentioned sources. This is why the plants are developed in the USSR with use of both gamma-ray sources (cobalt-60) and electron accelerators³. All this is in agreement with modern intentions resulted in an analysis of the 4th Geneva Conference material and exactly with intentions in the field of manufacturing plants for radiation sterilization with the quantity use of gamma-radiation of radioisotope sources (mostly cobalt-60) and the electron linear accelerator² for treatment of the products.

Unit for Radiation Sterilization of the Medical Products

The plant with Co⁶⁰ irradiator represented in Figure 1 is intended for sterilization of single use products of plastic material as well as metal needles. The unit (developed at AUSRI RT) has been included into the mill technological process for manufacturing the mentioned products.

Principle of Operation. Medical supplies are sterilized by means of gamma-radiation of Co⁶⁰ isotope. A planar irradiator consists of the whole complex of the standard sources. Products placed in a package are located by means of a charging device into suspension brackets of the conveyor and move through a maze to the irradiator zone. Item irradiation is carried out when it passes the irradiator on either side.

After this, the supplies by means of the maze are taken out of the irradiation zone to a position of vertical transferring packages contained in the suspension bracket or to the position of discharging.

Unit Design. The unit occupies a 7m-high two-story building the total area of which is 300 square meters. It consists of an irradiation chamber with a maze, an irradiator storage, a transport conveyor TP-80 type, a setting-up chamber, a radiation table, a radioactive isotope accumulator, manipulator and a control console.

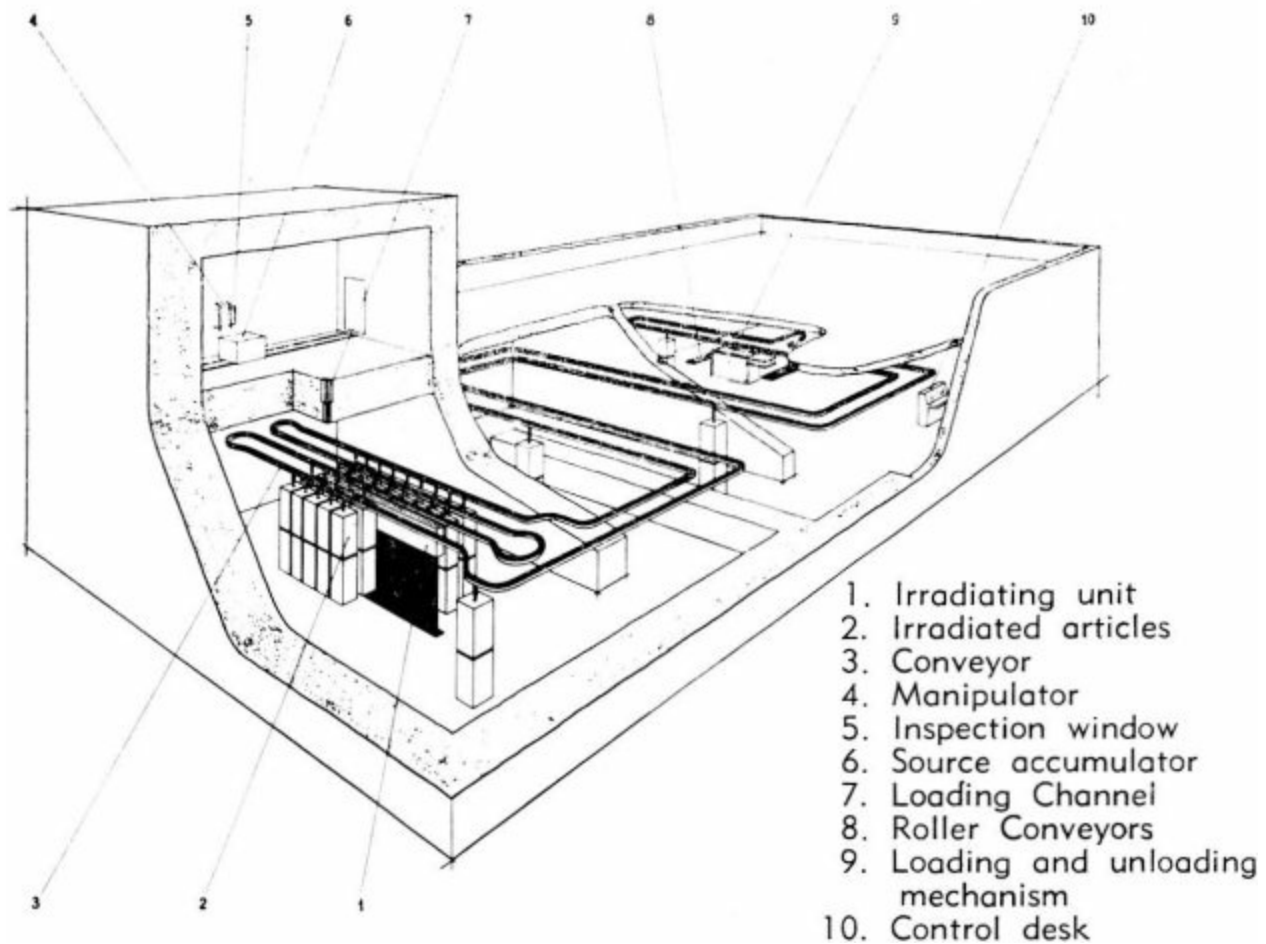

Figure 1. Commercial gamma-radiation plant for radiation sterilizing medical supplies.

The radiation chamber is 3.5 m height and its area is about 100 square meters. Biological shielding is 2 m thick (concrete, ρ within the range of 2.1 - 2.3 t/m³). Exposure dose rate outside the biological shielding area and at the maze exit does not exceed 1.4 mr/h (1.0×10^{-10} A/kg).

The maze is intended for transferring both a charging side and a discharging one of the conveyor and it is provided with a door and an electromechanical lock. The chamber includes the following members: the transport conveyor, the irradiator and the irradiator storage.

The irradiator discussed is a vertical plane consisting of an array of 103 rods. This plane is 2.4 m length and 1.0 m high. Each rod is made of a steel tube with radiation sources and a stepped plug. The upper part of the irradiator is made as a stepped plate.

Some slides are attached to either side of the irradiator for slipping along the guides when the irradiator moves. The irradiator is equipped with a system of emergency discharging the sources into the storage and a hydraulic brake.

The irradiator design allows for periodical filling up the irradiator with Co⁶⁰ sources in order to sustain the necessary output for the whole period of wear and tear of the unit ($T_{\text{wear}} = 10$ yr).

The irradiator storage is made as a rectangular stepped slot in the radiation chamber floor and supplied with a thermal shield as a steel block with a heat exchanger of a coil form the function of which is to cool the sources and concrete of the storage.

In order for the products to be transferred the conveyor is equipped with an automatic addressing weight TP-80, which includes sections for straight and rotating movement. The conveyor line is designed in four rows in relation to the irradiator plane (two rows at each end). The packages of

medical products to be irradiated are arranged in two rows (by height) in suspension brackets, the movement of which is realized by means of a pushing chain giving intermittent movement with the speed 10 m/min.

An assembly chamber intended for charging and discharging the irradiator has been designed above the 4 m by 5 m by 3.5 m irradiation chamber. Its walls, floor and the ceiling are made of concrete which serve as a biological shield.

A viewing window is provided in the chamber. The chamber discussed includes: a radiation table, a container-accumulator, a manipulator, M-22, intended for mounting the irradiator.

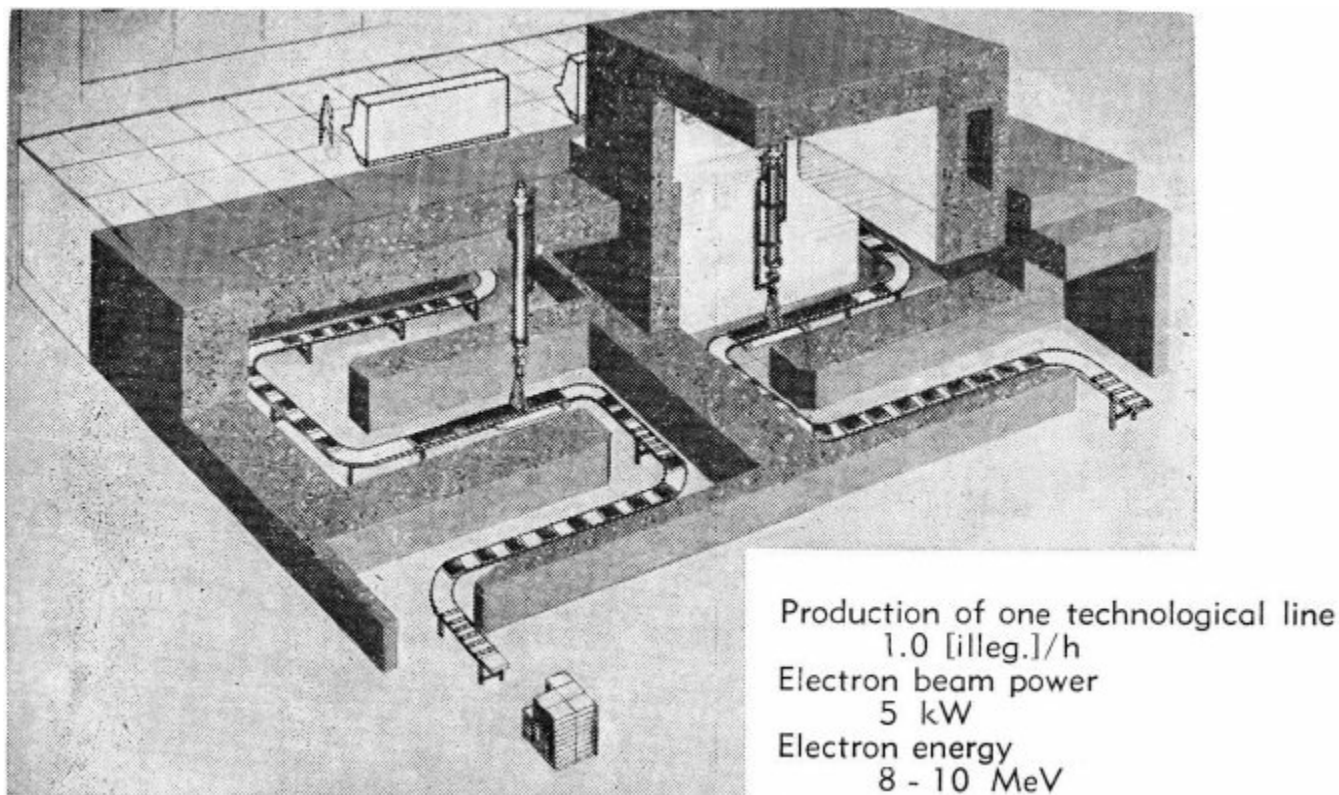

Figure 2. Commercial radiation plant with two electron linear accelerators for radiation sterilizing medical supplies.

Radiation sterilization process observation is carried out in the operator shop, where a control console is installed. Control is possible as a result of the availability of the following system: a system transferring the items of irradiation, a signalling system, an interlock system, a system of dosimetric control.

Technical and Operating Characteristics of Gamma-Ray Unit

Single standard Co^{60} source dimensions $\phi \times H$, mm	11 × 80.5 (MPTY 10-62-68)
Initial activity of the mentioned source, curie	1.91×10^3
Irradiator activity, curie	$(0.6 + 0.8) \times 10^6$
Integral absorbed dose, J/kg (Mrad)	2.5×10^4 2.5
Coefficient of non-uniformity, %	20
Coefficient of radiation utilization, %	more than 30
Overall dimensions of a package of irradiated products, mm	570 × 570 × 760
Irradiation circuit	continued, two-sided, multirowed
Voltage supplied, V	380/220

Power required, kw	20
Water consumption, m ³ /h	5
Air flow consumption for ventilation and cooling, m ³ /h	10 ⁴
Operating mode	continued, 24-hr operation

Commercial Unit with a Linear Electron Accelerator for Sterilizing Medical Supplies

When designing such powerful units some principal requirements should be borne in mind, that is: — a radiation source (a linear electron accelerator) should be simple in design and reliable in operation, and the energy of incident electrons should be sufficient to secure total electron penetration through the whole thickness of the irradiated products; — continuous feeding of the products to be sterilized to the radiation zone and stabilization of the transfer device should be secured.

The unit (see figure 2) is designed for sterilizing medical supplies made of polymer materials by means of an accelerated electron beam⁴.

The unit is supplied with a linear accelerator or a pair of them depending upon the capacity of the unit, reliable requirements and as a rule its arrangement is carried out after the final packaging of the medical products has been completed.

The principle of operation is based on irradiation of packaged medical products by means of an electron linear accelerator LUE-8/5V, the products transfer through the beam of accelerated electrons being scanned as a band diametrically to the conveyor movement.

Unit Design. The unit includes two automated technological radiation treatment lines and is housed in a two story building 9.5 m high with a total area of 700 m². The technological line consists of the following members: an electron linear accelerator, a radiation chamber, a transfer device, a system of automation, a protective interlock and a control console.

A single-section linear accelerator LUE-8/5V (see Figure 3) has been developed to perform the radiation sterilization process on an industrial scale. As for changing accelerated electrons beam parameters the mentioned accelerator is of low potentialities, but it has the following characteristic features: simplicity in design, reliability when operating and low costs. When installing the accelerator above the horizontal conveyor line there is no need to use a beam-bending magnet due to the vertical arrangement of an accelerating system in the irradiator assembly.

The accelerator operation stability results in stabilizing supplied voltage (accuracy $\pm 1\%$) and the temperature of the accelerating system and generator CBR (accuracy $\pm 1^\circ\text{C}$). Operating mode in each subsequent energizing is reproduced with accuracy up to $\pm 2.5\%$ with no additional adjustment.

After diffusing an accelerated electron beam into a band by means of scanning it with frequency range 0.5 - 2c/sec with use of the beam-bending magnet the beam is taken out via an aluminium or titanium foil window.

The radiation field at 200 mm distance from the foil represents a band 500 mm long by 30 mm wide. Non-uniformity of electron flow density within this length when scanning the beam does not exceed $\pm 5\%$.

Start and control of the technological line is performed remotely from the control console.

The radiation chamber 9.5 m high with the area of 120 square meters is a concrete block which serves as a shield with mazes provided. The chamber in question is intended for loading and unloading

the products. The radiation chamber design provides separation of batches of products received to be sterilized. The biological shield is 2.8 m thick (concrete, ρ in the range of 2.1 - 2.3 t/m³). The exposure dose rate level outside the biological shield and in the maze exit area does not exceed 1.4 mr/h (1.0×10^{-10} j/kg). The electron linear accelerator, a transfer device, service lands are housed into the chamber. Entering the chamber and maintenance of the accelerator and the transfer device are realized by means of the first and the second storys with the help of the mazes. Doors with an electromagnetic lock and an automatic interlock system which is a part of the power supply circuit are installed at the maze entrance.

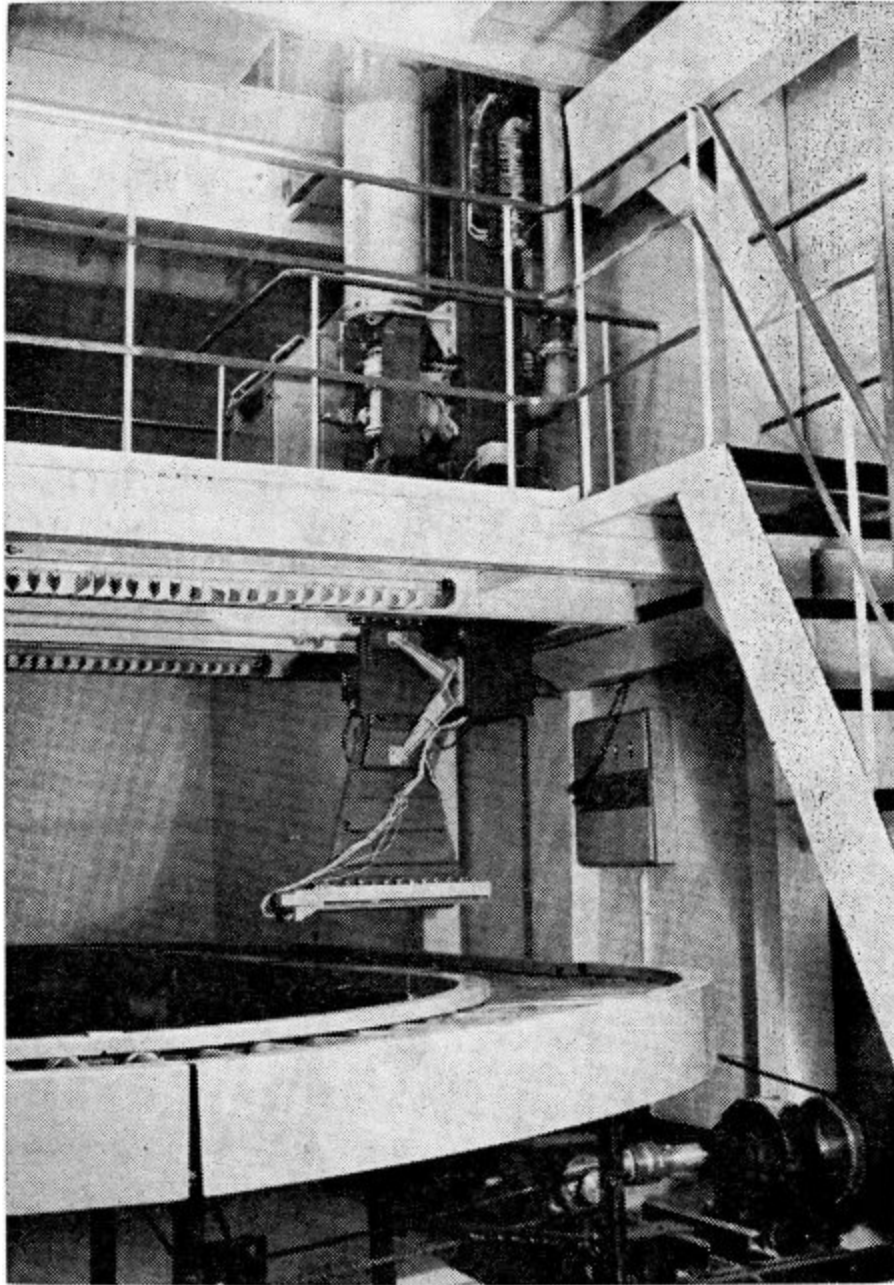

Figure 3. Electron linear accelerator LUE-8/5V.

The transfer is intended for transporting the products to be sterilized away from the load station and then into the unload one. It is assembled from four conveyors. These are as follows: a loading conveyor; a compacting conveyor; a radiation conveyor; an unloading conveyor — all of them are subsequently disposed in the horizontal plane at the height of 0.8 m over the floor level.

The transfer members of the conveyors in width are equal to the minimal width of the accelerator scanner. The loading and unloading conveyors represent a roller transporter consisting of sections to

provide directive and rotative movements. The roller conveyor enables one to have failure-proof transferring of the packed items along both the direct and indirect sections when moving via the mazes. The compacting conveyor is used as product accumulator and is intended for continuous feeding of "the radiation conveyor" (its place of operation is in the irradiation zone), which is a transporter with a metallic grid. All the transfer members of the transfer devices are made of stainless steel, and as for the radiation conveyor it is totally made of steel XI8HIOT type as well as a travelling belt. Such a constructive solution of the problem results in increasing the plant costs, but allows having trouble-free operation in conditions of powerful ionising radiation source surroundings. That is why higher materials radioresistance requirements are made. All the conveyors are connected kinematically and energized by a servo motor installed outside the radiation chamber. The servo motor power is 1.3 kw.

Transporting velocity of the grid of the belt conveyor is stabilized with an accuracy not less than $\pm 2\%$ and it is possible to be adjusted. Nominal velocity of moving the products at the minimal radiation dose of 2.5 Mrad is 0.8 cm/sec.

The plant is equipped with instrumentation, a monitoring apparatus, a relay protective system, a dosimetric apparatus, all that is necessary to control the main plant parameters and provide safety for the personnel. A TV camera is provided for visually observing the radiation sterilization process. Control is realized from an operator shop where a control console is installed.

It should be noted that the scientific workers of sterilization facilities in the U.S.S.R. take into consideration more strongly initial data than those which are taken abroad. This is attributed to the fact, that in specific radiation-technological plants being developed are inserted into a technological process as a part of the complete industrial enterprises, and they are not centres for sterilizing medical or other supplies, which exist independently of the given type of industry.

Just that very case i.e. the specific radiation-technological plants potentially provide the highest technological and economic characteristics.

Technical and Operating Characteristics

Radiation source — an electron linear accelerator	LUE-8/5V
Nominal accelerated electrons energy, MeV	8-10
Accelerated electron beam power, kw	5
Single technological line capacity at a dose level of 1 Mrad and a product density of $0.15 + 0.2 \text{ g/cm}^2$, t/h	0.9
Integral absorbed dose, J/kg	2.5×10^4
(Mrad)	2.5
Non-uniformity of the absorbed dose, %	25
Coefficient of radiation utilization, %	60
Overall dimensions of irradiated products, cm	$60 \times 50 \times 20$
Transfer device velocity stability, %	± 2
Range of changing transfer device velocity, cm/sec	0.03 — 3
Transfer device width, cm	50
Accelerator disposition	vertical
Pulse duration of accelerated electrons current, $\mu \text{ sec}$	2.8
Maximum pulse repetition rate,	500/sec
Energy spectrum (at the middle of the spectrum curve height), %	not less ± 7
Accelerator efficiency, %	about 10
Time period for which the operating mode is in full scale, min	not more 30

Plant power required (for a line), kw	100
Voltage supplied, v	3/380
Water required (for a line) m ³ /h	10
Pressed air consumption (for a line) m/h ³	50

References

1. *Power Radiation Technology*, ed. by S. Jefferson [Russian translation], Moscow, Atomizdat, 1967.
2. E.E. Fowler, Latest achievements in the field of application of isotopes and radiation in the USA, Paper P/340 at the 4th Geneva Conference, 1971.
3. Proceedings of the 19th Session of the Regular Commission of the SEV* on the application of atomic energy for peaceful purposes (Part III, Appendix 5 and 6), Moscow, 1970.
4. Kon'kov N.G. et al., Sterilization of Medical articles made from polymers with the aid of a linear electron accelerator. In: *Radiatsionnaya tekhnika* [Radiation Technology], No. 6, Moscow, Atomizdat, 1971, p. 186.
5. Nikolaev V.M., Linear electron accelerators for sterilization and radiation chemistry. Paper at the All-Union Scientific-Technical Meeting on the Utilization of Accelerators in National Economy.
6. "Linear Electron Accelerations for Sterilization and Radiation Chemistry". International Nuclear Industries Fair Nuclex 69, Oct. 1969.
7. Vanyushkin B.M. et al., Means for transporting block objects to the site of irradiation by a beam of accelerated electrons. Paper at the All-Union Scientific-Technical Meeting on the Utilization of Accelerators in National Economy and Medicine, Leningrad, February 1971.

Cobalt-60 Irradiator Designs

A. Brynjolfsson

Radiation Laboratory, US Army Natick Laboratories, Natick, Mass 01760, USA.

The physical characteristics of the irradiation process and the principal features in the design of the irradiators are discussed in this paper. Equations for calculating the dose and dose distribution in research irradiators and industrial facilities are given

Abstract: *and illustrated with examples. It is shown, for example, how the dose and dose distribution varies with product density in a typical facility. Equations are also given for the shielding thicknesses, the size of the source storage pool, the ozone production, and the required exhaust system.*

Introduction

Irradiation by cobalt-60 gamma rays is the simplest and most reliable method of sterilization of most medical products and equipment. The medical industry has used this method increasingly in the last fifteen years. Reluctance in introducing the method has frequently been due to unfamiliarity with the nuclear technology used in the irradiation facilities. In what follows we put into focus some of the concepts and some of the principles underlying the designing of cobalt-60 facilities. For further analysis of design we refer to references 1 through 8, and for operational costs we refer to references 9 through 12.

Nuclear Technology Glossary

Cobalt-60

Cobalt is a steel-gray metal with a density of 8.83 g/cm^3 and a melting point of 1490°C . Its physical and chemical characteristics are similar to those of iron and nickel. For example, cobalt is ferromagnetic.

Cobalt-60 is produced in nuclear reactors. The natural cobalt, cobalt-59, has 27 protons and 32 neutrons. When inserted in a stream (flux) of slow neutrons, cobalt-59 absorbs a neutron and becomes cobalt-60, which is radioactive. It emits an electron, a β -particle, from the nucleus and is transformed thereby from cobalt-60 to nickel-60. This nickel nucleus is highly excited, and immediately following its formation, two gamma rays are emitted, one with energy of 1.1732 MeV and the other of 1.3325 MeV.

Gamma rays

The nature of gamma rays is the same in all respects as that of X-rays (Roentgen rays or bremsstrahlung) that are so well known in the medical profession. These rays are called gamma rays if they are created inside the nucleus of the atom and X-rays if they are created outside the nucleus. They

are electromagnetic waves just like light. Their wave length is shorter, however, than that of visible light. The wave length of cobalt-60 gamma rays is ~ 0.001 nm (nm = nanometers = 10^{-9} meters = 10 Angstroms). In comparison, the wave length of bluegreen light is 500 nm.

The electron volt unit

One electron volt is the energy an electron gains when it falls through a potential difference of one volt. Its relation to other energy units is:

$$\begin{aligned} 1 \text{ eV} &= 1.602 \cdot 10^{-12} \text{ ergs} \\ &= 1.602 \cdot 10^{-19} \text{ joules} \\ &= 3.83 \cdot 10^{-20} \text{ calories} \end{aligned} \tag{1}$$

It is a practical unit when considering atomic reactions because the bond strengths between atoms are usually in the range of 0.1 eV to 10 eV. Light with a wave length of 500 nm corresponds to a light quantum with an energy of 2.47 eV. The gamma rays are more energetic and are usually measured in million electron volts, abbreviated MeV.

The half-life

Cobalt-60 changes gradually to nickel-60, and thus fewer and fewer cobalt-60 atoms are left intact. After 5.27 years only half of the original cobalt-60 remains; after 10.54 years half of the half, or one quarter of the original cobalt-60 atoms remains intact. This corresponds to a reduction in the cobalt-60 activity by 12.324% per year or 1.096% per month. The time it takes the activity to reduce to half its value is called half-life.

The curie unit

The strength of a radioactive source is usually measured in the unit curie (the internationally recognized abbreviation is Ci). A curie is defined as $3.7 \cdot 10^{10}$ nuclear transformations per second. If all the natural cobalt-59 atoms could be transformed into cobalt-60, we would have 1150 Ci per gram of cobalt. The practical specific activity is much smaller; usually it is between 3 and 300 Ci/g. If the neutron flux in the reactor is 10^{14} neutrons/(cm² sec) at the position of cobalt-59 in the reactor then 30.8 curies/g are produced in 90 days.

The rad unit

Gamma rays are absorbed by the materials they penetrate. The amount of radiation energy absorbed characterizes best the biological effects of the radiation. The greater the energy absorbed the greater is the biological effect. On the other hand, the biological effect is very nearly independent of the energy of the gamma rays and independent of the nature of the commonly used types of ionizing radiations, gamma rays, X-rays, and fast electrons.

The absorbed energy is measured in the unit rad, which corresponds to 100 ergs of radiation energy absorbed per gram. We have, therefore,

$$\begin{aligned}
1 \text{ rad} &= 100 \text{ ergs/g} \\
&= 6.24196 \cdot 10^{13} \text{ eV/g} \\
&= 10^{-5} \text{ joules/g} = 10^{-2} \text{ joules/kg} \\
&= 2.389 \cdot 10^{-6} \text{ cal/g}
\end{aligned}
\tag{2}$$

The energy radiating from cobalt

The energy radiated from one curie of cobalt is given by

$$\begin{aligned}
&3.7 \cdot 10^{10} \cdot (1.17 + 1.33) 1.602 \cdot 10^{-13} \text{ watt} = \\
&14.85 \cdot 10^{-3} \text{ watt}
\end{aligned}
\tag{3}$$

where $3.7 \cdot 10^{10}$ is the number of nuclear transformation (decays); 1.17 and 1.33 are the energies in MeV (million electron volts) of the two gamma rays; and $1.602 \cdot 10^{-13}$ is the factor for converting MeV to joules.

From Eq. (3) we derive that the radiation intensity emitted from 1000 Ci of cobalt-60 is 14.85 watts, and

$$67,300 \text{ Ci of cobalt-60 emit 1 kwatt}
\tag{4}$$

The Absorption of Cobalt-60 Gamma Rays

Like X-rays, gamma rays penetrate thick materials. A fraction of the rays is absorbed, however, and their intensity decreases, therefore, with thickness. In the first 40 cm of water the cobalt-60 gamma ray intensity is reduced by approximately 1.64% per cm. The energy absorption process consists of a primary event in which the electromagnetic field in the gamma ray kicks an electron out of an atom. The atom, so ionized, is raised thereby to a highly excited state. The de-excitation of this highly excited atom will often result in ionization and excitation of several of the surrounding atoms. The electron kicked out in the primary process is usually very energetic and will cause most of the overall ionizations and excitations. Close to the cobalt-60 source each primary ionization leads to approximately 17,000 secondary ionizations. Further away, 63 cm in water, from the source where many of the gamma rays are softer (less energetic, longer wave lengths) we have for each primary ionization approximately 1,400 secondary ionizations. Most of the ionizations and excitations are thus created by the electrons produced in the primary event. We may understand from this why irradiation by gamma rays produces the same effect as irradiation by electrons from accelerators.

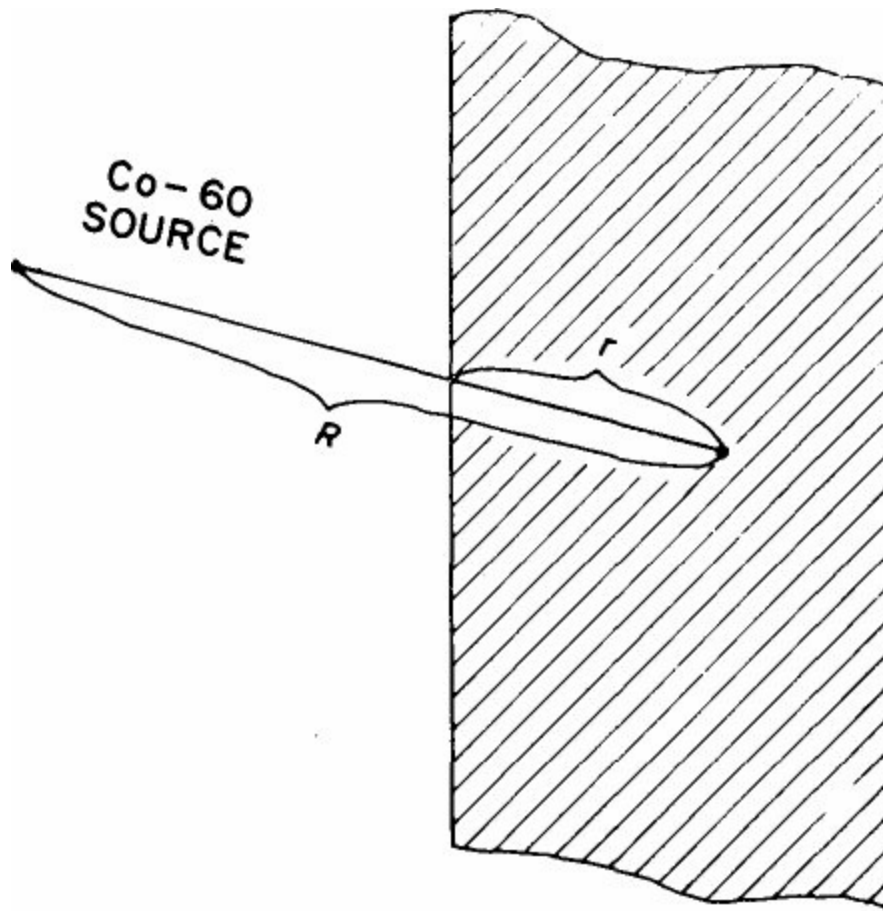

Figure 1. A sketch of the parameters used in Eq. (5).

The energy q absorbed close to a point P in a material (see Figure 1) is given by

$$q = 1.18 \cdot 10^4 \cdot \mu \cdot C \cdot B_e \cdot \frac{\exp(-\mu_t \cdot r \cdot \rho)}{R^2} \text{ erg}/(\text{g} \cdot \text{sec}) \quad (5)$$

where

μ = energy absorption coefficient in $\text{cm}^2/\text{g} = 0.0297 \text{ cm}^2/\text{g}$ in water

C = number of curies of cobalt-60

B_e = energy absorption buildup factor

μ_t = total absorption coefficient in $\text{cm}^2/\text{g} = 0.0632 \text{ g}/\text{cm}^2$ in water

r = distance of gamma ray penetration in the material (see Figure 1)

ρ = density of the penetrated material

R = distance from the source to the point considered (see Figure 1)

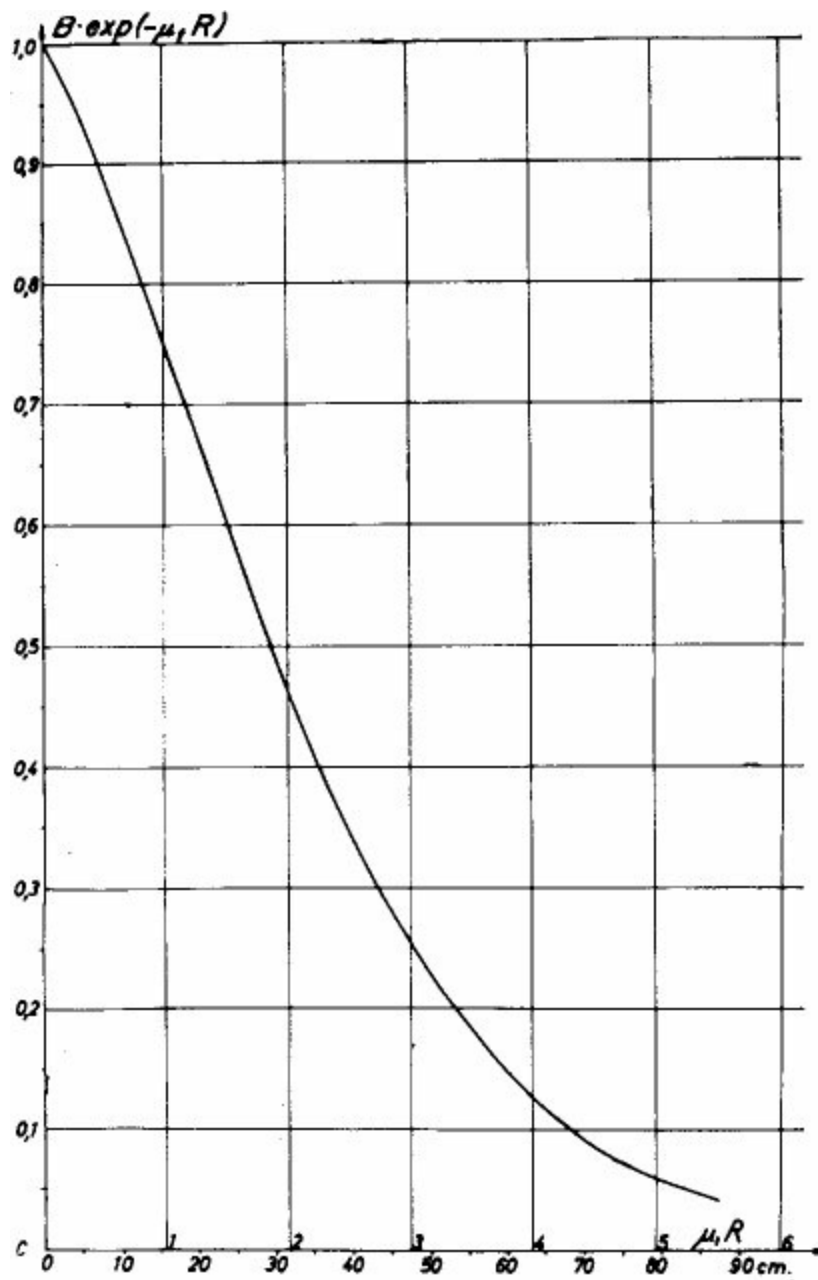

Figure 2. The ordinate shows, for cobalt-60 rays, the function $B_e \cdot \exp(-\mu_t \cdot \rho \cdot r)$; and the abscissa shows the corresponding distance R in cm from a point isotropic cobalt-60 source in water (see Eq. (5)).

Figure 2 shows the function $B_e \cdot \exp(-\mu_t \cdot \rho \cdot r)$ for a cobalt-60 source (free from self-absorption) embedded in a big water container. Figure 2 can be used with reasonable accuracy for other materials containing only light atoms, such as foods and some plastics, by scaling the distance r by $\rho_n \cdot 1.8 \cdot Z_n/A_n$ where Z_n and A_n are the atomic number and atomic weight of the absorbing materials and, ρ_n its density.

For distances less than 47 cm in the absorbing material, a good approximation for $B_e \cdot \exp(-\mu_t \cdot r \cdot \rho)$ is the straight line defined by $1 - 0.0164 r$ (see Figure 2).

For the cobalt-60 source in the center of a large water container Eq. (5) may then be written in the form

$$q = 1.26 \cdot 10^4 \cdot C \left[\frac{1 - 0.0164 \cdot r}{R^2} \right] \text{ rads/hour} \tag{6}$$

Single user license provided by AAMI. Further copying, networking, and distribution prohibited.

More generally, we may sometimes use the following approximation for other light materials

$$q = 1.26 \cdot 10^4 \cdot C \frac{1 - ar}{R^2} \quad (6a)$$

where

$$ar = b = 0.0295 \sum \rho_n \cdot \frac{Z_n}{A_n} \cdot d_n \quad (6b)$$

where ρ_n , Z_n , A_n , and d_n are respectively the density, the atomic number, the atomic weight, and thickness of the materials in between the source and the considered point P.

Irradiation Geometries

The shapes of the source and the sample and their relative position varies greatly. Calculations of the dose in the sample are usually complicated and lengthy, and are usually done by numerical calculation on a computer which produces lengthy tables.

It is then useful to consider some simple models of possible irradiation geometries, to gain an insight into how to interpolate and extrapolate the measurements of the dose at the different points. For this purpose we shall consider the two main classes of irradiation geometries:

A. Cylinder geometry

B. Plane geometry

A. Cylinder Geometry

In the cylinder geometry the source usually forms a circular cylindrical surface around a circular sample cylinder. This configuration is used in many commercial portable research irradiators with lead shields (see Figure 3). The source may also be in the form of a single rod if the sample cylinder rotates during the exposure (see Figure 4). The source may even be in the form of a point source if the sample cylinder moves axially as it rotates (see Figure 5). The two first geometries are approximately equivalent with respect to dose distribution and will be discussed first.

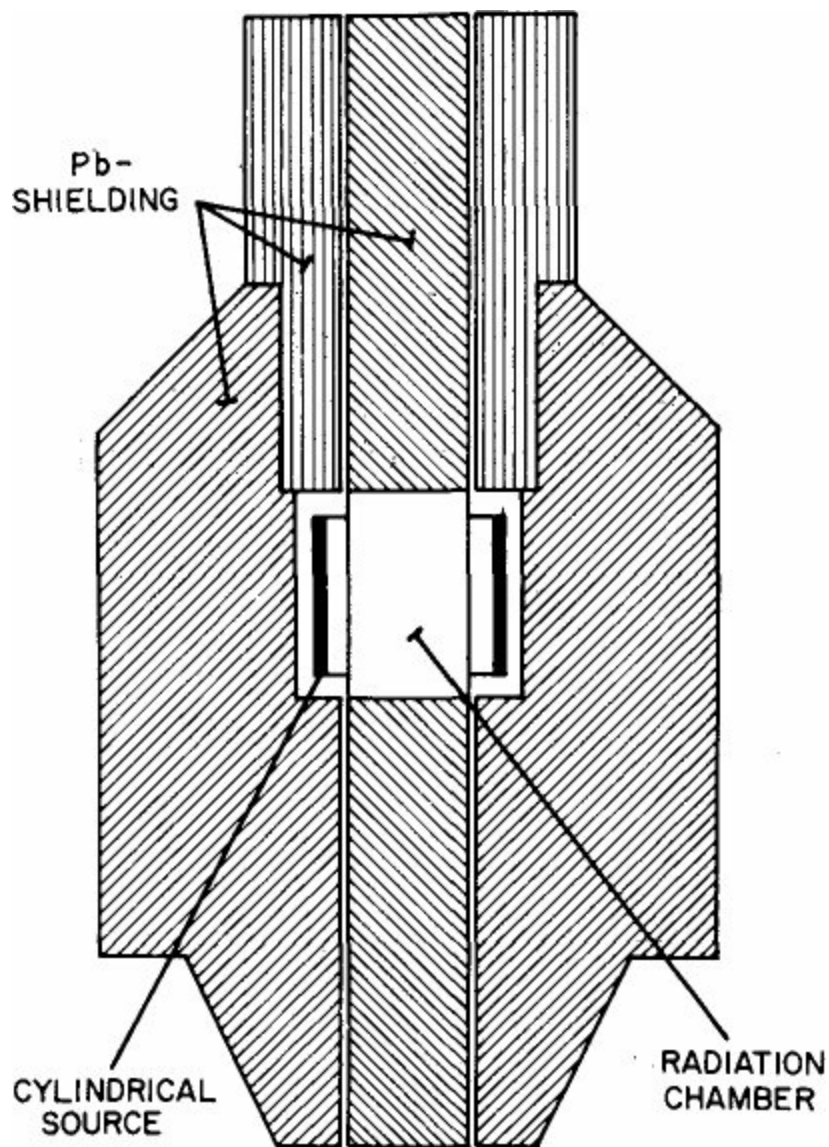
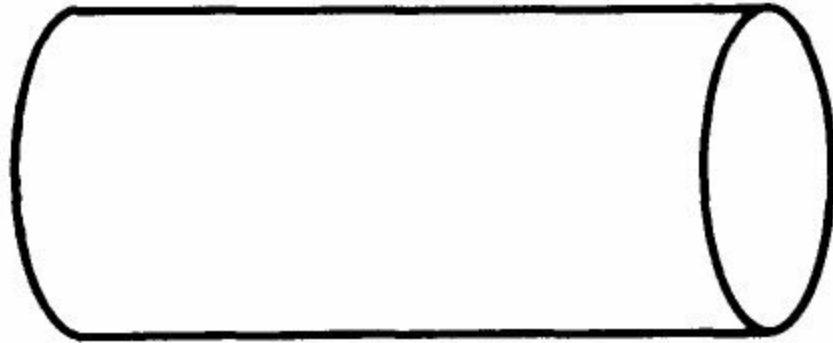

Figure 3. The portable research irradiator above is an example of a sample source arrangement having a “cylinder geometry.” The dose on the axis of the irradiation chamber is given by Eqs. (7), (8), (9), and (10).

Cylindrical Source and Cylindrical Sample

We will assume that the cobalt-60 activity C curies is uniformly distributed in the source cylinder similar to that shown in Fig. 3. The radius of the source cylinder is R cm and its height is $2H$ cm. The sample has radius r and height $2H$.

COBALT - 60 ROD



SAMPLE CYLINDER

Figure 4. In the "cylinder geometry" the source may be in the form of a rod, if the cylindrical sample rotates during exposure.

The dose $q(z)$ at any point P on the axis of the sample cylinder, z cm above (or below) the center of the cylinder is

$$q(z) = 1.26 \cdot 10^4 \frac{C}{2H \cdot R} \cdot [F_1(z) - b \cdot F_2(z)] \text{ rads/hour} \quad (7)$$

where

$$F_1(z) = \text{Arctg} \frac{H - z}{R} + \text{Arctg} \frac{H + z}{R} \quad (8)$$

and

$$F_2(z) = \ln \frac{H - z + \sqrt{(H - z)^2 + R^2}}{R} + \ln \frac{H + z + \sqrt{(H + z)^2 + R^2}}{R} \quad (9)$$

$$b = 0.0295 \sum_n \rho_n \frac{Z_n}{A_n} \cdot d_n \quad (10)$$

where ρ_n is the density, Z_n the atomic number, A_n the atomic weight, and d_n the thickness of the material n between the axis and the source.

Examples of dose rate calculations in a research irradiator with a cylindrical source: A 1,000 curie source is composed of 5 mm thick cobalt-60 strips with 2.5 mm thick stainless steel encapsulation arranged into a source cylinder that is 10 cm in radius and 20 cm high. The sample is water in a 2 mm thick aluminum cylinder, r cm in radius and 20 cm high. Using Eq. (10) we get

$$\begin{aligned} b &= 0.0295 \left(8.9 \frac{27}{59} \cdot 0.25 + 7.9 \frac{26}{56} \cdot 0.25 + 2.7 \frac{13}{27} \cdot 0.2 + \frac{10}{18} \cdot r \right) \\ &= 0.0648 + 0.0164 \cdot r \end{aligned}$$

The dose in the center, $z = 0$, is obtained from Eqs. (7), (8), and (9)

$$q(0) = 1.26 \cdot 10^4 \frac{1,000}{200} \left[\frac{\pi}{2} - (0.0648 + 0.164 \cdot r) 1.763 \right] \text{rads/hour}$$

or

$$q(0) = 9.9 \cdot 10^4 [1 - 0.073 - 0.0184 \cdot r] \text{rads/hour} \quad (11)$$

the 7.3% absorption term in the bracket is partly due to the 6.5% self-absorption in the source and partly to the 0.8% absorption in the water container. Each centimeter of the radius of the water container reduces the dose by 1.84%.

The dose close to the end of the water cylinder is similarly obtained:

$$q(10) = 6.98 \cdot 10^4 [1 - 0.084 - 0.0214 \cdot r] \text{rads/hour} \quad (12)$$

A Point Source and a Cylindrical Sample

In this geometry, shown in Figure 5, points parallel to the axis receive the same dose, and by proper shields (see Figure 5) the dose distribution in the radial direction may be improved over the previously mentioned cylindrical source geometry. When designing the research facility at Risø, Denmark, shown in Figure 6, this author took advantage of these principles.

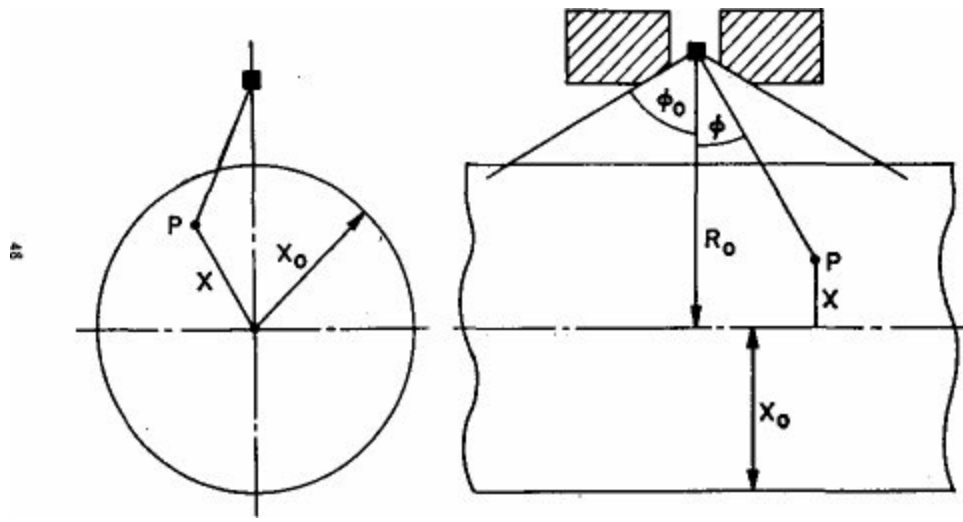

Figure 5. In the "cylinder geometry" the source may be in the form of a "point source", if the cylindrical sample rotates as it moves axially. The figure shows the parameters used in Eq. (13) for the dose distribution in the sample.

The average dose rate $q(x)$ over the exposure angle $2\phi_0$ (see Figure 5) and at a distance x cm from the axis of the sample cylinder is

$$q(x) = \frac{1.26 \cdot 10^4 \cdot C \cdot \phi_0}{R_o^2 \cdot \text{tg}\phi_0} (\psi_1 - b_1\psi_2) \quad (13)$$

where

$$\psi_1(x/R_o) = \frac{2}{\pi} \int_0^{\pi/2} [1 - (x^2/R_o^2) \cos^2\phi]^{-1/2} \cdot d\phi \quad (14)$$

$$\psi_2(x/R_o, x_o/R_o) = \psi_2 = \frac{2}{\pi} \int_0^{\pi/2} [1 - (x^2/x_o^2) \cos^2\phi]^{1/2} [1 - (x^2/R_o^2) \cos^2\phi]^{-1/2} \cdot d\phi \quad (15)$$

$$q_1(x) = 1.26 \cdot C \cdot 10^4 \int_{x_o - x}^{R_o} \left[1 - \frac{x_o - x}{X_o - x} \cdot \ar \right] r^{-2} \cdot 2\pi r \cdot dr \quad (16)$$

and where

- C = number of curies of Co-60
- ϕ_0 = the maximum of ϕ (see Figure 5)
- R_o = the source distance from the cylinder axis
- x = distance from the cylinder axis

x_0 = radius of the sample cylinder = the maximum of x

The values of the elliptical function ψ_1 and ψ_2 are shown in Figures (7) and (8).

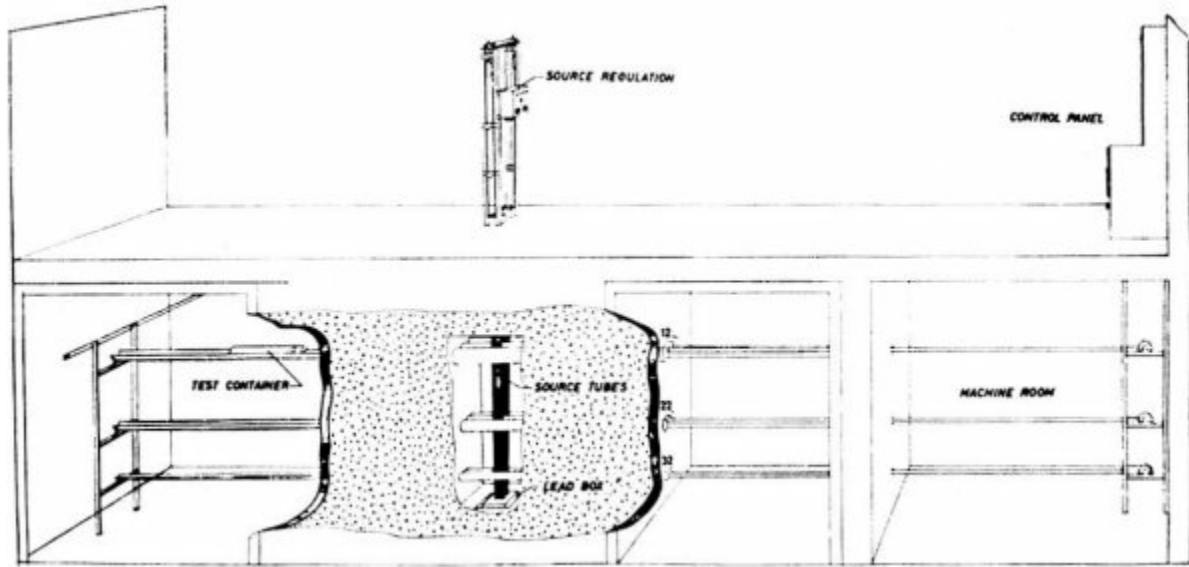

Figure 6. The cobalt-60 research irradiation facility at the Danish Research Establishment, Risö (April 1958). The dose distribution in the samples is given by Eq. (13).

Example of a dose rate calculation in a research irradiator with a point source and a screw motion of a cylindrical sample: A 1,000 curie point source is a cobalt-60 plate 5 mm thick encapsulated in 2.5 mm thick stainless steel. The sample cylinder is of 2 mm thick aluminum and is x_0 cm in radius and very long. The distance of the source from the axis is 10 cm. The cut off angle ϕ_0 is 45° .

Inserting these values in Eqs. (13) and (16) we get

$$q(x) = 9.9 \cdot 10^4 (\psi_1 - (0.0648 + 0.0164 x_0) 1.122 \cdot \psi_2) \quad (17)$$

On the axis of the sample cylinder both ψ_1 and ψ_2 are equal to 1. Comparing Eq. (17) for $x = 0$ with Eq. (11) we see that the dose on the axis (Eq. (17)) is the same as in the center (Eq.(11)). The dose variation with the distance x from the axis of the sample cylinder may be found by inserting the function ψ_1 and ψ_2 shown in Figures (7) and (8). In Figure 9 we show this radial variation of dose for three values of x_0 in Eq. (17) $x_0 = 2.5$ cm, $x_0 = 5$ cm, and $x_0 = 8$ cm. See curves II, III, and IV. Curve I in Figure 9 corresponds to zero absorption term.

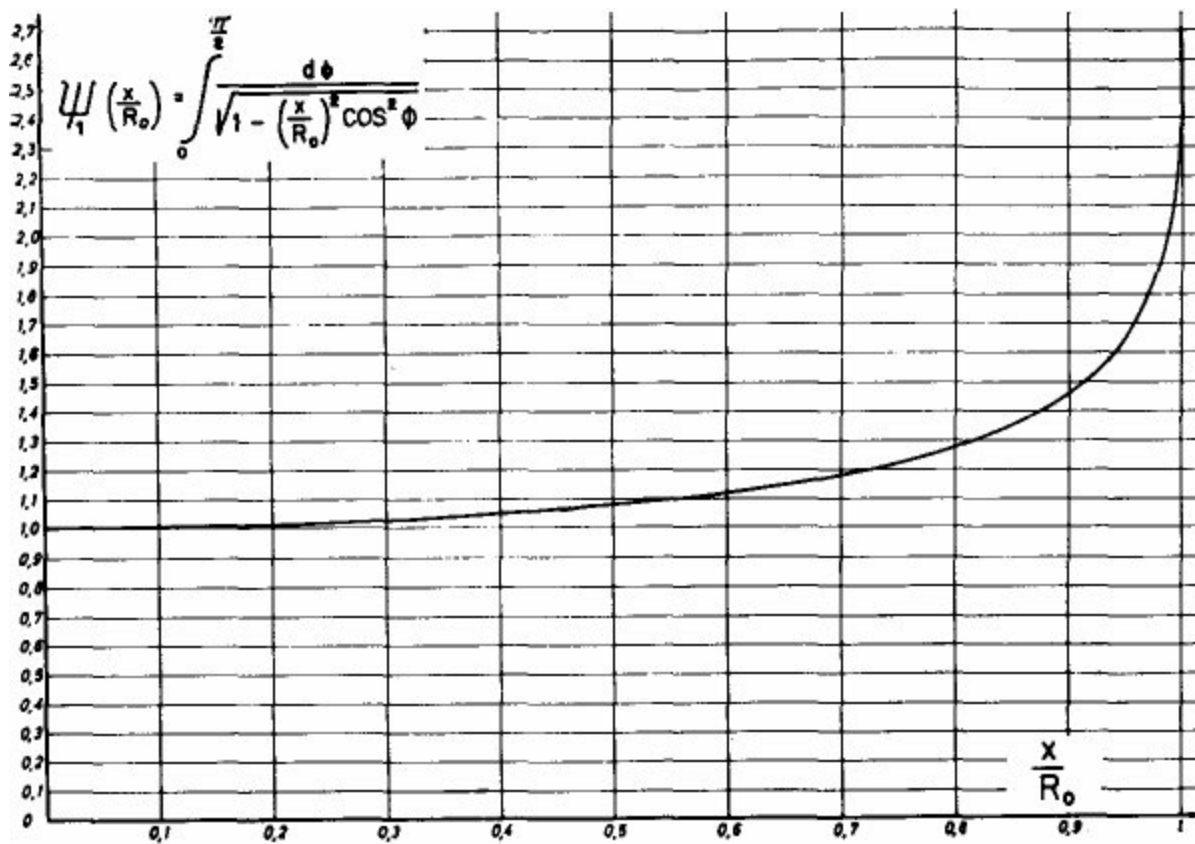

Figure 7. The function Ψ_1 (see Eq. 14) shows for density $\rho = 0$ the radial variation of dose in the cylinder geometry shown in Figure 5.

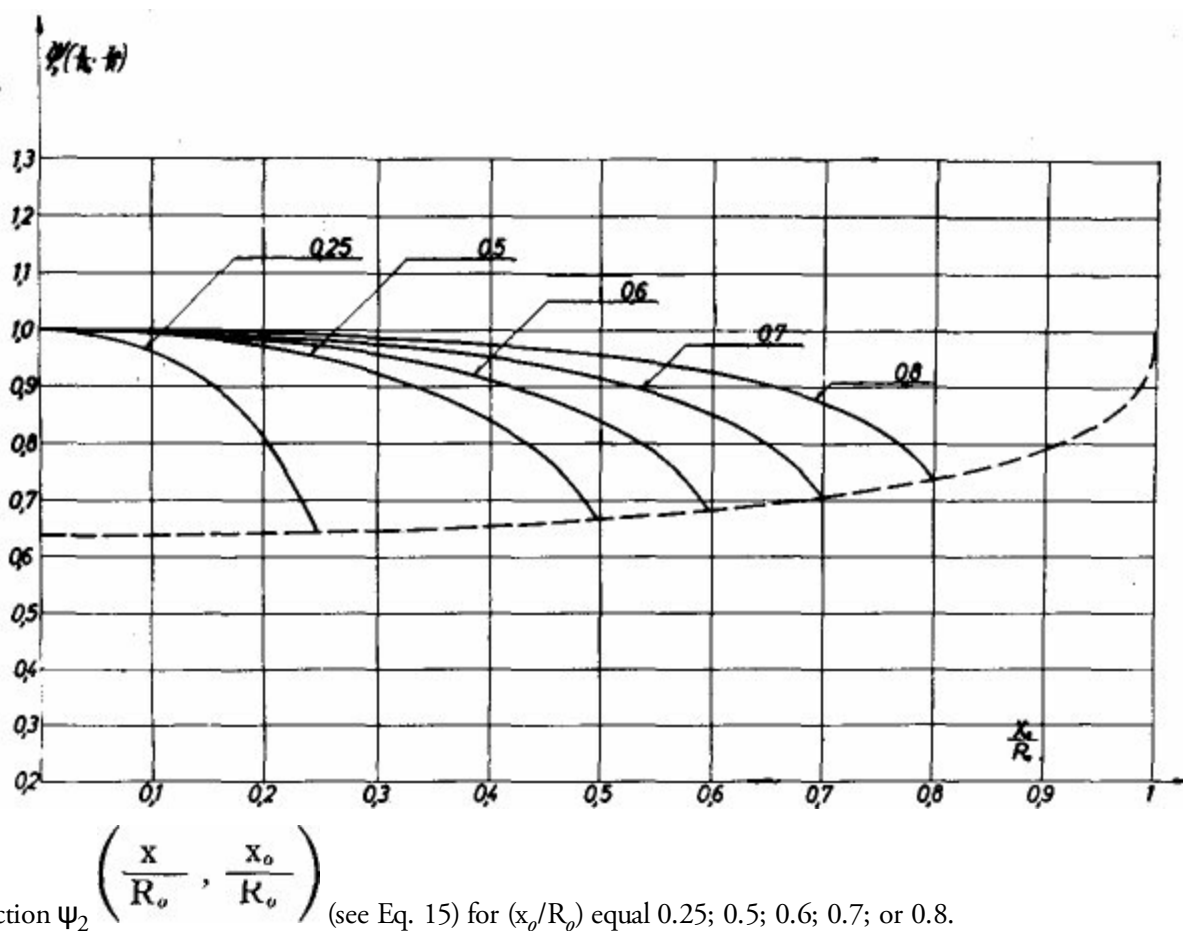

Figure 8. The function $\Psi_2\left(\frac{x}{R_0}, \frac{x_0}{R_0}\right)$ (see Eq. 15) for (x_0/R_0) equal 0.25; 0.5; 0.6; 0.7; or 0.8.

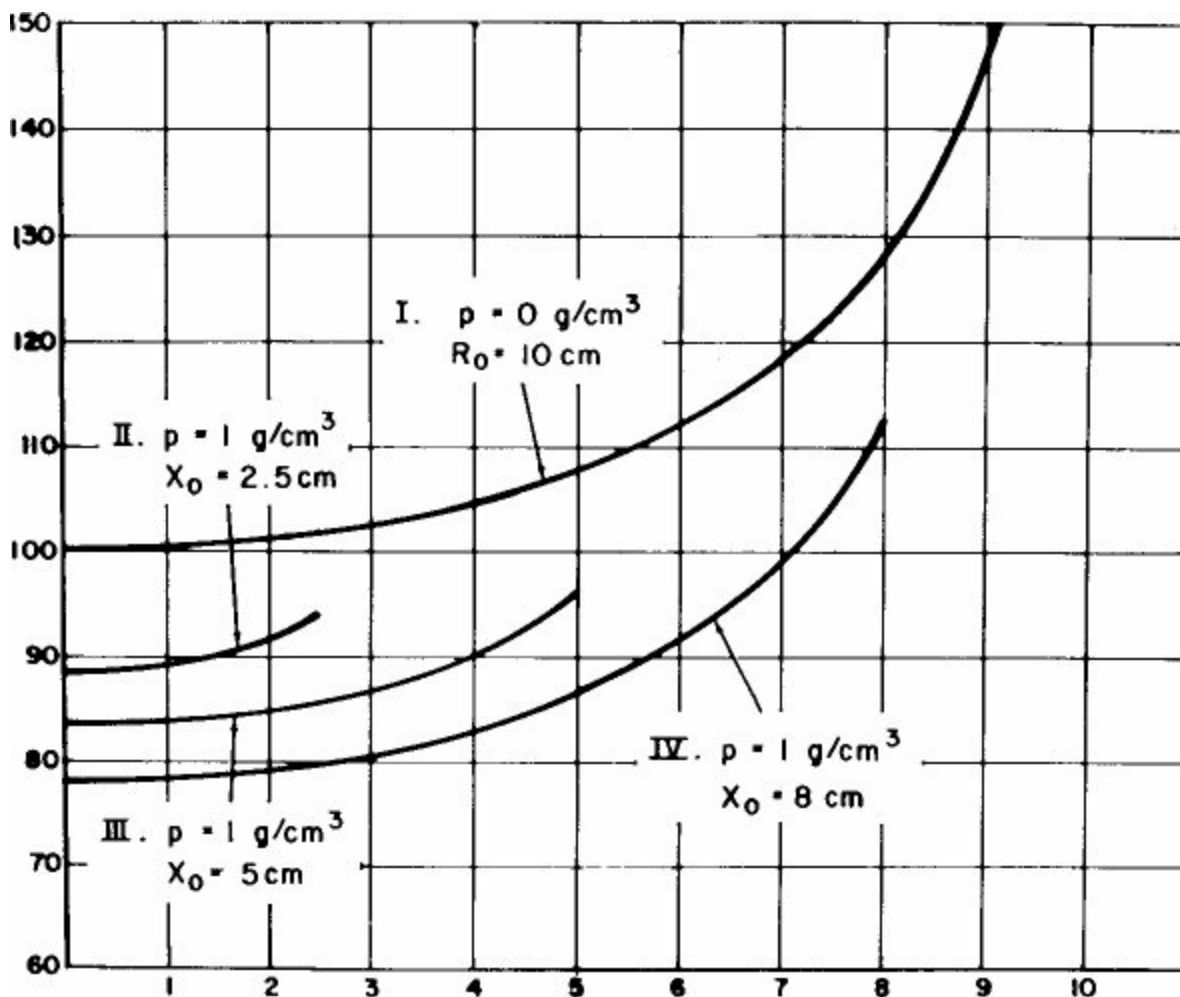

Figure 9. The radial variation of dose in the cylinder geometry shown in Fig. 5 when $\rho = 1 \text{ g/cm}^3$ and for $R_0 = 10$ and x_0 equal 2.5 cm, 5 cm, and 8 cm.

B. Plane source geometry

This geometry is most commonly used in industrial facilities. The cobalt-60 source is made up of several elements of modules that are arranged in a plane. The product, packaged in standard unit sizes, is moved, tightly packaged, around the source, see Figure 10.

Infinity Source Plane

To analyze the dose distribution in these facilities let us consider Figure 11, which shows two “infinite” plane sources on each side of the product. Using the nomenclature shown in Figure 11 we have

$$q_1(x) = 1.26 \cdot C \cdot 10^4 \cdot \int_{X_0 - x}^{R_0} \frac{1 - a \cdot \frac{X_0 - x}{X_0 - x} \cdot r}{r^2} \cdot 2\pi r \cdot dr \quad (18)$$

where C is the number of curies per cm^2 of the source plane. The constant a is defined in Eq. (6b). The numerator in the integrand must always be positive. That is

$$\text{ar} \cdot \frac{X_o - x}{X_o - x} < 1 \text{ or } R_o \leq \frac{X_o - x}{a(x_o - x)} = R_{max} \quad (19)$$

We must also have that

$$R_o \leq X_o - x \quad (19a)$$

where

$$R_o = R_{max} = \frac{X_o - x}{a(x_o - x)} = \frac{X_o - x}{b} \quad (20)$$

We add the contributions from the two sources, one on each side of the sample, and get

$$D(x) = q_1(x) + q_2(x) = 1.26 \cdot 10^4 \cdot 2\pi \cdot C \cdot \left[f_1(b) + f_2\left(\frac{x}{x_o}\right) \right] \text{ rads/hour} \quad (21)$$

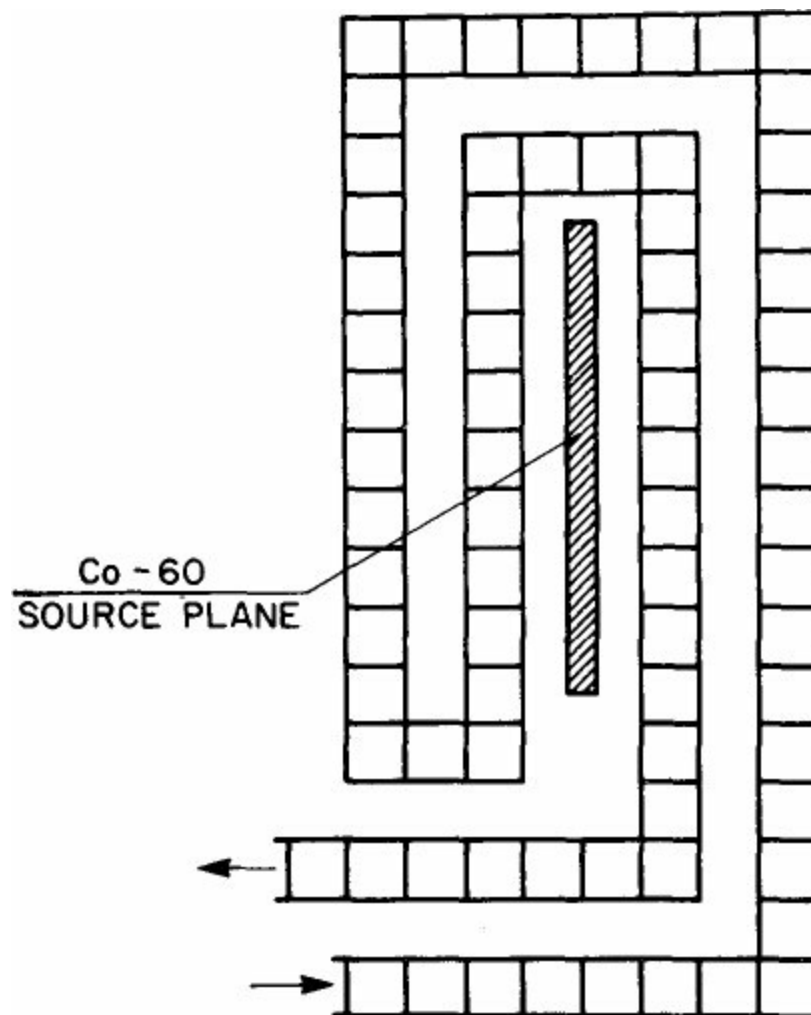

Figure 10. A sketch of the source and the product movement in an industrial facility using a "plane source geometry" For every large source the dose distribution is given by Eq.(21), while for a finite source it is given by Eq. (30).

where

$$f_1(b) = 2b - 2 \ln b - 2 \quad (22)$$

$$b = 0.0295 \sum \rho_n \cdot \frac{Z_n}{A_n} \cdot d_n \quad (23)$$

and

$$f_2\left(\frac{x}{x_0}\right) = -\ln\left(1 - \frac{x^2}{x_0^2}\right) \quad (24)$$

D_0 in the center plane of the sample is then

$$D_0 = 1.26 \cdot 10^4 \cdot 2\pi \cdot C \cdot f_1(b) \text{ rads/hour} \quad (25)$$

and the variation of the dose with x is

$$D(x) - D_0 = 1.26 \cdot 10^4 \cdot 2\pi \cdot C \cdot f_2\left(\frac{x}{x_0}\right) \text{ rads/hour} \quad (26)$$

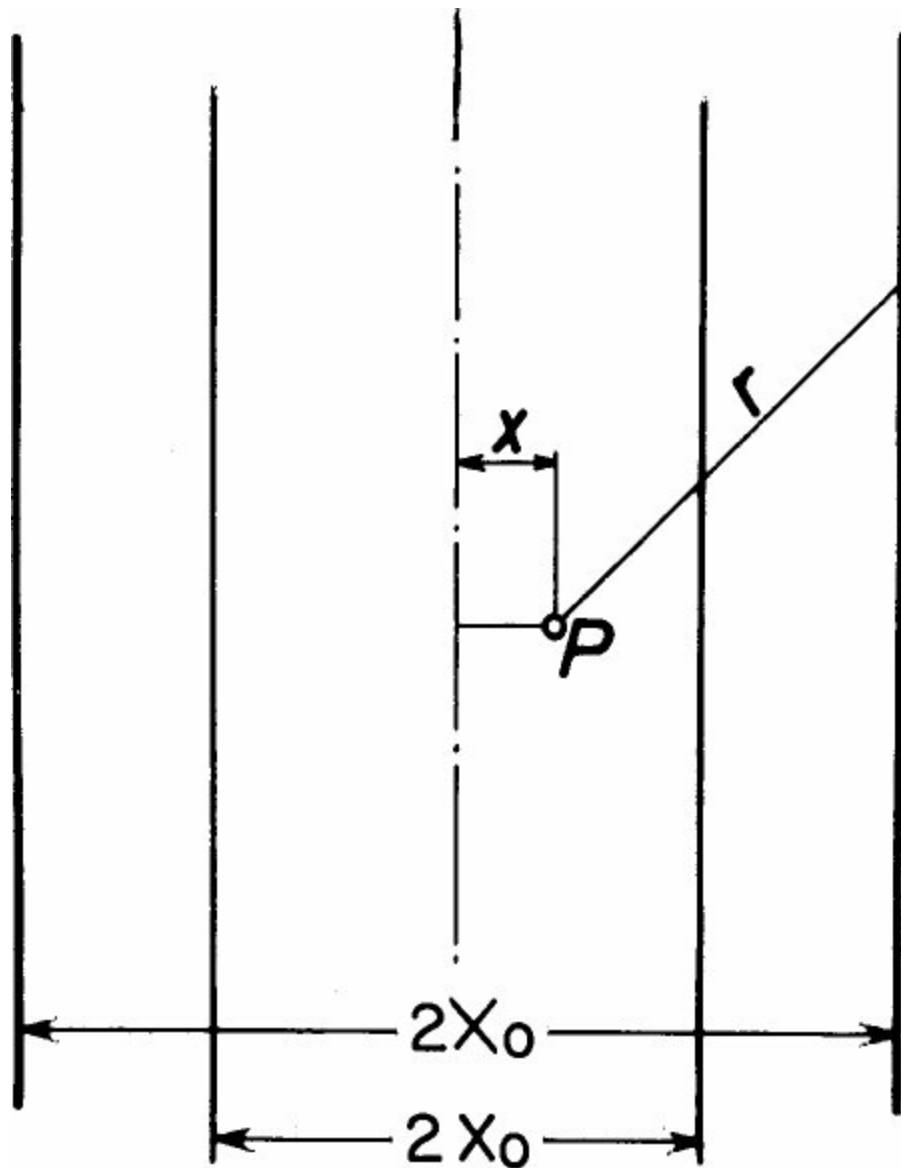

Figure 11. A sketch of the parameters used in the calculations of the dose in an irradiation geometry using a plane source.

Infinite Source Rods

We consider a source that consists of two very long parallel source rods each containing C_1 curies per cm of their lengths. We assume a continuous flow of samples moving at a speed v cm/hour between the source rods. The direction of the sample movement is perpendicular to the source rods.

The dose in the centerplane of the sample is then

$$D_o = 1.26 \cdot 10^4 \cdot 2\pi \cdot \frac{C_1}{v} \cdot f_1(b) \text{ rads/hour} \quad (27)$$

More generally the dose at a distance x from the center plane of the sample (this plane is assumed to be parallel to the source rods) is

$$D(x) = 1.26 \cdot 10^4 \cdot 2\pi \cdot \frac{C_1}{v} \left[f_1(b) + f_2 \left(\frac{x}{d} \right) \right] \quad (28)$$

where

C_1 = number of curies per cm of the source rods

v = conveyor speed in cm/hour

and $f_1(b)$ and $f_2(x/d)$ are the functions defined by Eqs. (22) and (24).

Finite Source Plane

In Eqs. (20) through (26) we have assumed that the source plane was very large such that the absorption would cut off the contributions of the distant parts of the source plane, that is for distances $R_0 \geq R_{max}$ where R_{max} is given by Eq. (20). When Eq. (20) is fulfilled, the dose distribution is the same as from an infinite source plane.

If on the other hand, Eq. (20) is not fulfilled, that is

$$R_0 \geq R_{max} = \frac{X_0 - x}{a (x_0 - x)} \quad (29)$$

then the dose distribution will be a function of the actual maximum distance R_0 in different directions. The variation with R_0 makes accurate calculations of the dose complicated and time consuming. One may often find, however, an approximate dose by using an average R_0 because the distant parts contribute very little to the total dose.

We find for $(x/X_0)^2 \ll 1$ a fair approximation for a limited source by replacing Eq. (21) by

$$D(x) = 1.26 \cdot 10^4 \cdot 2\pi \cdot C [F_1 + F_2] \text{ rads/hour} \quad (30)$$

where

D = dose in rads/hour

C = curies of cobalt-60 per cm^2

$$F_1 = 2 \left[b \left(1 - \frac{R_0}{X_0} \right) + \ln R_0/X_0 \right] \quad (31)$$

$$b = 0.0295 \sum \rho_n \cdot \frac{Z_n}{A_n} \cdot x_n \quad (32)$$

$$F_2 = -\ln \left(1 - \frac{x^2}{X_0^2} \right) + 2b \frac{R_0}{x} \frac{1 - \frac{x_0}{X_0}}{\left(\frac{X_0}{x} \right)^2 - 1} \quad (33)$$

For $x = 0$ and $R_0 = X_0/b$ we find that Eqs. (30) and (21) are equivalent.

Finite Source Rod

The source consists in this case of two equal parallel rods, each containing C_1 curies per cm. The length of each rod is $2R_1$ and the distance between them is $2X_0$. The contour of the two rods forms thus a rectangle with sides $2R_1$ and $2X_0$.

We assume further that

$$R_0 = \sqrt{R_1^2 + X_0^2} < \frac{X_0 - x}{b} \quad (34)$$

where R_0 is the distance from the center of the rectangle to the end of the source, and b is defined in Eq. (32).

The samples move at a speed of v cm/hour in a direction perpendicular to the source rectangle. The length of the irradiation conveyor is approximately $2R_1$, that is, R_1 on each side of the plane containing the sources.

The dose $D(x)$ received by the center portion of the sample is

$$D(x) = 1.26 \cdot 10^4 \cdot 2\pi \cdot \frac{C_1}{v} [F_1 + F_2] \quad (35)$$

where F_1 and F_2 are defined by Eqs. (31), (32), and (33).

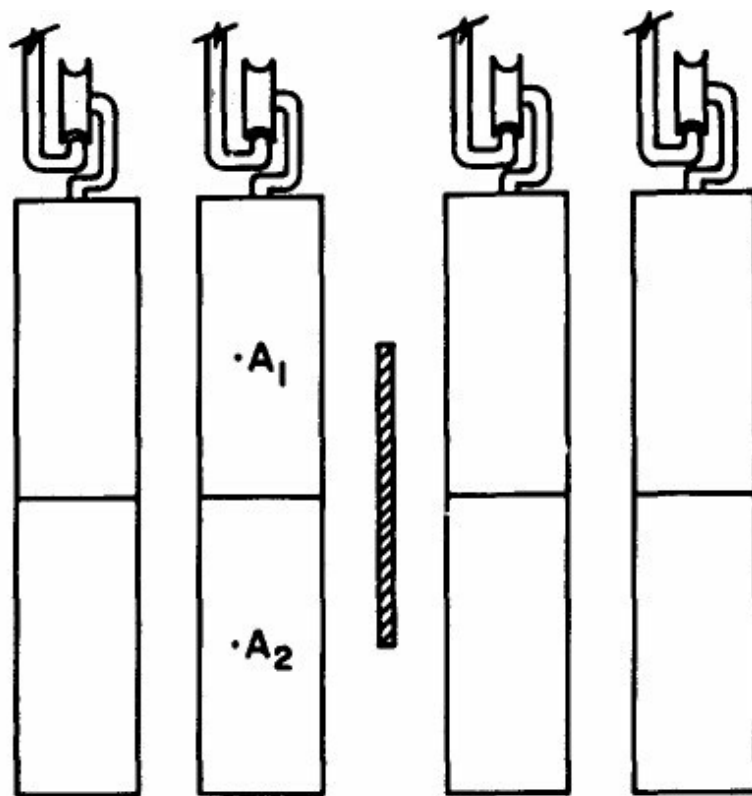

VERTICAL CROSS SECTION

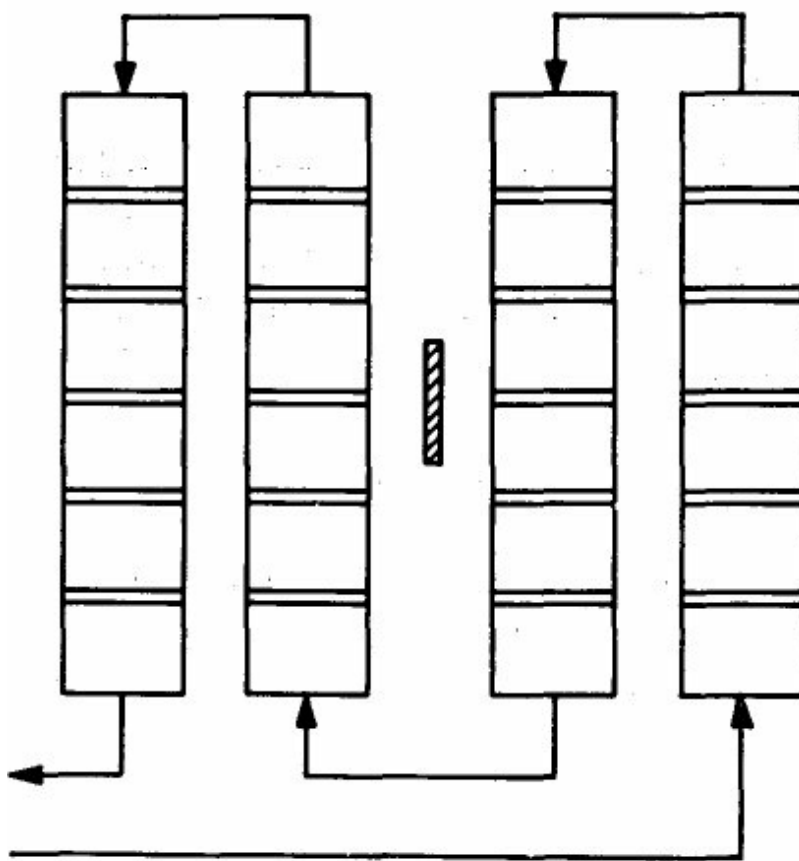

HORIZONTAL CROSS SECTION

Figure 12. A sketch of the irradiation geometry in an industrial irradiation facility. An example of the dose distribution and the irradiation efficiency for such a facility is shown in Table I and Table II.

Example of dose calculation in an industrial facility with sources in the form of a rod (or plane) and product in the form of boxes in carriers pushed around the source:

We assume that the design of the irradiation geometry is similar to that shown in Figure 12. We will make rough estimates of the dose received when the product passes at a uniform speed of v cm/hour through the facility and we will calculate how the dose varies with the density of the product.

Description

The source consists of 5 parallel strips arranged in a rectangular frame. Each strip is 1 m long and 2 cm wide. The thickness of the cobalt strips is 5 mm and they are encapsulated in 2.5 mm stainless steel. The total source strength is 200,000 curies or $C_1 = 2,000$ curies per cm length of the source.

The irradiation carriers, 2 m by 0.33 m by 0.33 m, are of 2 mm aluminum. The long sides of the carriers are parallel to the source strips as they move through the facility. The carriers are pushed around as shown by the arrows. When the product in the upper half of each carrier has been once around the source, it is moved into the lower half of the carrier which brings it again around the source. In this way the product goes twice around the source, first in the upper half of the carrier and then in the lower half. A point P' at A_1 in the product (see Figure 12) will first see the source stretching 1 m downwards and the same product point, when in the lower half at the point A_2 , will see the source as if it was stretching 1 m upwards. The total dose received by the point P' will be the same as if it moved once past the center of a source 2 m long. By viewing Figure 12, we may also see that the passage of the product around the source is equivalent to passage between two source rods.

The distance X_0 from the source to the center plane of the carriers in the first row is $X_{01} = 30$ cm, and to the second row $X_{02} = 70$ cm.

The value of b is dependent on product density. In the first row it is

$$b_1 = 0.0295 \left(8.9 \frac{27}{59} \cdot 0.25 + 0.79 \frac{26}{27} \cdot 0.25 + 2.7 \frac{13}{27} \cdot 0.2 + \rho \cdot \frac{10}{18} \cdot 16.5 \right) = 0.06476 + 0.2704 \cdot \rho$$

In the second row b is similarly

$$b_2 = 0.0801 + 0.8113 \rho \quad (37)$$

The value of R_0 in the first row is:

$$R_{01} = \sqrt{100^2 + 30^2} = 104.4 \text{ cm} \quad (38)$$

In the second row we have:

$$R_{02} = \sqrt{100^2 + 70^2} = 122.1 \text{ cm} \quad (39)$$

The absorbed dose $D = D_1 + D_2$ is the sum of the dose D_1 absorbed in the rows closest to the source and the dose D_2 absorbed in the second rows. We calculate $D_1(0)$ and $D_2(0)$ by use of Eq. (28) when Eq. (20) is valid and by use of Eq. (35) when Eq. (34) is valid. We find when

$$k = 1.26 \cdot 10^4 \cdot 2\pi \cdot 2000/v \quad (40)$$

that $D_1(0)$ is given by

$$D_1(0) = k \cdot F_1 = k \cdot 2 \cdot \left[b_1 \left(1 - \frac{R_o}{X_o} + \ln \frac{R_o}{X_o} \right) \right] \\ = k \cdot [2.17 - 1.34\rho] \text{ rads/hour} \quad (41)$$

$$\text{for } \rho \leq 0.823 \text{ g/cm}^3 \quad (42)$$

and

$$D_1(0) = k \cdot f_1 = k \cdot 2 \cdot [b_1 - \ln b_1 - 1] \text{ rads/hour} \quad (43)$$

$$\text{for } \rho \geq 0.823 \text{ g/cm}^3 \quad (44)$$

where b_1 is given by Eq. (36)

Analogously we find the dose $D_2(0)$ for the second row given by

$$D_2(0) = k \cdot F_1 = k [0.99 - 1.21\rho] \quad (45)$$

$$\text{for } \rho \geq 0.608 \text{ g/cm}^3 \quad (46)$$

and we have

$$D_2(0) = k \cdot f_1 = k \cdot 2 [b_2 - \ln b_2 - 1] \text{ rads/hour} \quad (47)$$

$$\text{for } \rho \leq 0.608 \text{ g/cm}^3$$

where b_2 is given by Eq. (37)

To calculate the increase in dose with x we may use $F_2(x)$ for low densities ($\rho < 0.53 \text{ g/cm}^3$), and $f_2(x)$ for high densities ($\rho > 0.72 \text{ g/cm}^3$). In the intermediate density range we must calculate the contribution to the dose separately for the carriers when on the left side and when on the right side of the source.

In Table I we show the doses $D_1(0)$, $D_2(0)$, and $D(0) = D_1(0) + D_2(0)$ in the center of the carriers; and the doses $D_1(b)$, $D_2(b)$, and $D(b) = D_1(b) + D_2(b)$ close to the carrier sides parallel to the source.

Table I. — The doses $D_1(0)$, $D_2(0)$, and $D(0) = D_1(0) + D_2(0)$ in the center of the carriers shown in Figure 12; and the doses $D_1(b)$, $D_2(b)$, and $D(b) = D_1(b) + D_2(b)$ at the carrier sides parallel to the sources as functions of the product density ρ in the carriers $k = 1.26 \cdot 10^4 \cdot 2\pi \cdot C/v$, where C is the number of Ci/cm and v is the conveyor speed in cm/hr.

ρ in g/cm ³	$\frac{D_1(0)}{k}$	$\frac{D_1(b)}{k}$	$\frac{D_2(0)}{k}$	$\frac{D_2(b)}{k}$	$\frac{D(0)}{k}$	$\frac{D(b)}{k}$	$\frac{D(b)}{D(0)}$
0.0	2.17	2.37	0.99	1.23	3.16	3.60	1.14
0.1	2.04	2.29	0.87	1.07	2.91	3.36	1.16
0.2	1.90	2.21	0.75	0.91	2.65	3.12	1.18
0.3	1.77	2.13	0.63	0.76	2.40	2.89	1.20
0.4	1.64	2.06	0.51	0.60	2.15	2.66	1.24
0.5	1.50	1.98	0.39	0.44	1.89	2.42	1.28
0.6	1.37	1.90	0.27	0.34	1.64	2.24	1.37
0.8	1.10	1.79	0.09	0.18	1.19	1.97	1.65
1.0	0.86	1.70	0.01				
1.2	0.67	1.64					

Table I illustrates how the doses decrease with increase in the product density ρ , and how the dose inhomogeneity $D(b)/D(0)$ increases with ρ . For $\rho < 0.53$ g/cm³ the doses decrease approximately linearly with increase in ρ .

Along the longest dimension of the carriers the dose decreases only slightly towards the ends. In the irradiation geometry considered above the dose close to the ends of the carriers is approximately 5% lower than in the middle of the carriers. In the actual design this dose variation along the axis can be compensated for by adjusting the specific source activity along the source rods. In the above design we could increase the source activity in the center portion of the rods.

The Efficiency

According to Eq. (3) we have that 1 joule = $10^5 \cdot \text{g} \cdot \text{rad}$, or

$$\begin{aligned}
 1 \text{ kwatt} \cdot \text{hour} &= 3.6 \cdot 10^6 \text{ joule} \\
 &= 3.6 \cdot 10^{11} \text{ g} \cdot \text{rad} \\
 &= 360 \text{ kg} \cdot \text{Mrad}
 \end{aligned} \tag{48}$$

That is, 1 kwatt of radiation can irradiate 360 kg per hour with a dose of 1 Mrad, if 100% of the radiation is absorbed in the product.

According to Eq. (4) we have that 67,300 Ci of cobalt-60 emit 1 kwatt. If the efficiency were 100% then 67,300 Ci could irradiate 360 kg per hour with a dose of 1 Mrad or 100 kg/hour with a dose of 3.6 Mrad. In actual designs not all the radiation is absorbed in the product. One fraction of the radiation is absorbed in the source, that is the self-absorption, another fraction in the conveyor, a third fraction in the product carriers, in the walls, the ceiling, and the floor. The fraction absorbed in the product, that is the irradiation efficiency η , is usually in the order of 10% to 40%.

In the facility shown in Fig. 12 we may use Table I to obtain the irradiation efficiency.

The amount x of product irradiated is

$$x = (v \cdot 33 \cdot 100\rho) \cdot 10^{-3} \text{ kg per hour}$$

and a dose $D(0)$ in the center of the irradiation box, that is at the point P, is

$$D(0) = 1.26 \cdot 10^4 \cdot 2\pi \cdot \frac{C_i}{v} \cdot \left[\frac{D(0)}{k} \right] \cdot 10^{-6} \text{ Mrad} \quad (49)$$

where the value of $\left[\frac{D(0)}{k} \right]$ is shown in Table I.

The minimum dose, which is found close to the ends of the irradiation box, is $D_{\min} = 0.95 \cdot D(0)$.

If the source strength is 67,300 Ci, $C_1 = 673 \text{ Ci/cm}$, then the efficiency η is given by

$$\eta = X \cdot \frac{0.95 \cdot D(0)}{360} = 167 \cdot \rho \cdot \left[\frac{D(0)}{k} \right] / 360 \quad (50)$$

Table II. — The irradiation efficiency η as a function of the product density ρ in g/cm^3 for the irradiator shown in Figure 12.

ρ	η
0.1	0.14
0.2	0.25
0.3	0.33
0.4	0.40
0.5	0.44
0.6	0.46
0.8	0.44
1.0	0.40
1.2	0.37

where ρ and $\left[\frac{D(0)}{k} \right]$ are the values shown in Table I. In Table II we list the values of η , calculated in this way, as a function of ρ .

Concrete Shielding

For personnel protection, the walls and roof, when made of ordinary concrete, must be 140-190 cm thick. The dose q in rads/hour just outside a wall r cm thick is

$$q = 1.126 \cdot 10^4 \cdot C \cdot B_d \frac{\exp(-\mu_t \rho \cdot r)}{R^2} \text{ rads/hour} \quad (51)$$

where

C = source strength in curies

B_d = dose buildup factor

μ_t = total absorption coefficient in concrete = $0.060 \text{ cm}^2/\text{g}$

ρ = density of concrete = 2.3 g/cm^3

r = shielding thickness in cm

R = distance from the source in cm.

If $q = 10^{-4}$ rads/hour is an acceptable level, 55 and $R \sim 300$ cm, then the thickness r is given by

$$r = \left(181 + 16.7 \cdot \log_{10} \left(\frac{r \cdot C}{150} \cdot 10^{-6} \right) \right) \text{cm} \quad (52)$$

that is, $r = 181$ cm for a megacurie source 164 cm for a 100,000 Ci source and 147 cm for a 10,000 Ci source.

Cobalt-60 Sources

The total activity C of the source depends on the efficiency η and the required throughput rate x in kg/hour of product at a given dose D in Mrad. The relation determining the required source strength is

$$C = 1.87 \cdot 10^2 \cdot \frac{x \cdot D}{\eta} \text{ curies}$$

where

- C = source strength in curies
- x = kg of product
- D = dose in Mrad
- η = irradiation efficiency

Example: If $x = 500$ kg/hour; $\eta = 0.3$; and the dose 2.5 Mrad, then

$$C = 187 \cdot \frac{500 \cdot 2.5}{0.3} = 779 \cdot 10^3 \text{ curies}$$

The source activity per gram of cobalt, and the source activity per cm^2 of the source plane are significant factors in the design. The activity per cm^2 of the source is often in the range of 25 Ci/ cm^2 to 250 Ci/ cm^2 . A 1 million curie source with activity 250 Ci/ cm^2 would fill a plane approximately 0.4 m wide and 1 m high. If the activity is 25 curies per cm^2 the same source plane would be 4 m by 1 m. As the activity per cm^2 is decreased, the size of the source must be increased and then we also must increase the size of the source storage pool and the size of the irradiation room. The amount of product around the source must then also be increased and consequently the dwell time of the product in the cell must be increased.

We understand from this that high activity per cm^2 may be used to simplify the design and shorten the dwell time. To increase the source activity per cm^2 we may increase the thickness of the source plane rather than increase the specific activity per gram of cobalt. As the thickness increases, however, the self-absorption and the self-heating in the source increases.

When designing the source configuration, later replenishment of the source should be taken into consideration. The source plane should preferably be designed large enough; for example, with empty spaces, to allow adding new sources into the plane without removing old sources before these have

decayed to an insignificant level.

Installation of the Sources

The sources, inside a lead shielded container weighing 9-18 tons, may be brought into the facility through a hole in the roof above one end of the source storage pool. When the container is at the bottom of the pool, the lid is taken off and the sources are transferred into the frame that holds the sources. This frame is attached to an elevator which will raise the sources out of the pool when they are used for irradiation. The lid is then put back on the lead container, which is lifted up from the pool, out through the hole in the roof, and back on the truck for shipping. The hole in the roof of the irradiation room is then closed with a tight fitting concrete plug.

The Source Storage Pool

Sources less than 40,000 Ci, when not in use, may be kept in a dry lead shielded container under the floor. Larger sources, when not in use, are usually kept in large water pools under floor level. The water serves as a shield for the operators when they handle the sources close to the bottom of the pool using long tools. 100,000 Ci of cobalt-60 at 3.5 m depth of water will give a dose rate of approximately 0.1 millirad/hour at the surface. When the sources are removed from the container they are brought into a position 150-200 cm above the bottom of the pool. The water tank should, therefore, be 5 to 6 m deep.

The tank must be completely watertight to prevent leakage into the surrounding soil in case the water is contaminated. The tank may be of reinforced concrete thoroughly tightened and painted on the inside. Large sources should not lie on the bottom of the pool or be close to the wall because the radiation heating and outgassing may weaken the concrete and make it leak. The pool is lined, sometimes, on the inside with a stainless steel tank.

To minimize corrosion, the water is constantly recirculated through a deionizer with a flow rate of 15 lpm. The pH should be around 6.5 and the resistance greater than 100,000 ohm/cm. *A sensitive radiation monitor close to the deionizer* is used to pick up any activity in case the water should be contaminated by a leaking source.

The Labyrinth

The product is usually brought into the irradiation room through a labyrinth, which must have several bends to prevent escape of the radiation, and usually serves also as an entrance to the irradiation room. Exact calculations of the radiation leakage through the labyrinths are very difficult. By rule of thumb, a labyrinth should be so designed that to escape through the labyrinth the radiation has to be reflected at least three times. This is valid for most industrial size facilities if $A/R^2 \leq 1/7$ where A is the cross section of the labyrinth and R is the distance between two bends in the labyrinth. The ratio A/R^2 should be slightly smaller for megacurie facilities and could be slightly larger for smaller facilities.

Air Exhaust

Single user license provided by AAMI. Further copying, networking, and distribution prohibited.

Small amounts of ozone and nitrogen oxides are produced in the irradiation room during the

exposure. The ozone is toxic and the most important. It must be reduced to levels less than the tolerance concentration 0.1 ppm before entering the irradiation room. The production rate x of ozone is

$$x = 10^{-10} \cdot G \cdot C \cdot \bar{R} \text{ cm}^3/\text{sec} \quad (53)$$

where

x = production rate of ozone in cm^3/sec in air

G = number of ozone molecules formed per 100 eV of radiation energy absorbed = 13.8

C = source strength in curies

\bar{R} = average distance in cm from the source to the walls, ceiling, and floor of the irradiation room

Ozone is usually very unstable and G -values between 0.1 and 20 have been reported. In dry and cold weather the ozone may be rather stable. We will use a G -value, of 13.8 for the production of ozone reported by Ghormley *et al.*,¹³. R is usually in order of 2 m. We have then

$$x = 2.8 \cdot 10^{-7} \cdot C \text{ cm}^3/\text{sec} \quad (54)$$

If the exhaust rate is $v \text{ m}^3/\text{sec}$ then the maximum concentration in parts per million (ppm) is x/v . We will set this equal to 0.1 ppm and we get

$$v = 2.8 \cdot 10^{-6} \cdot C \text{ m}^3/\text{sec} \quad (55)$$

For a 1 million curie source the exhaust rate v should thus be $2.8 \text{ m}^3/\text{sec}$; and for a 100,000 curie source it should be $0.28 \text{ m}^3/\text{sec}$. The airflow is from the loading area in through the labyrinth into the irradiation room, which has negative pressure, and out the stack.

Radiation Protection

As in any other industrial facility, safety of personnel is of prime concern. We take measures to protect people from exposure to deadly high voltage lines, from being locked inside freezers, and from being exposed to leaking ethylene oxide gas from a ethylene oxide gas sterilization facility. Similarly, we must take measures to assure the safety of personnel in an irradiation facility.

The following procedures may be used. One and only one lockup key should be made available in the facility. To assure that no one is in the irradiation room when the sources are raised, the operator, as a first step in the starting procedures, must enter the irradiation room and there activate an interlock. The operator is then given one minute to leave the room through the only entrance, the labyrinth, and when outside the entrance to the labyrinth activate another interlock which automatically closes the entrance to the irradiation room. Not before this operation is concluded shall it be possible to raise the source.

The source elevator should be very reliable. In case of any abnormality, the sources should return to the storage position automatically. To prevent mechanical damage, the motor that raises the source should have a fast-acting torque sensing device that shuts the motor off and returns the sources to the

storage position if the torque is excessive. An analogous system should be used for the product conveyor to prevent damage to the sources in case the conveyor jams. In case the sources, despite the above precaution, jam in the up position the shielding should have conduit holes, normally plugged, through which some manipulation of the conveyors could be made.

To detect any leak of the sources activity into the water, a sensitive radiation monitor may be located close to the ion exchange beds of the water purification system for the source storage pool. This monitor should sound an alarm in case the activity exceeds a preset level.

A water level indicator in the source storage pool should sound an alarm in case the water level is low.

To demonstrate that the air is never contaminated, radiation detectors may be placed close to a filter in the air exhaust and at the entrance to the labyrinth.

When the source is down (supposedly) and the irradiation room accessible, a sensitive radiation monitor inside the room should become operative and sound an alarm if radiation level exceeds background.

All the interlocks should be failsafe; that is, if they malfunction, the sources should be locked in their down position.

To meet the personnel radiation protection requirements in most countries, monitoring and recording of any personnel exposure must be made. Activity levels of the water in the storage pool, and the activity of dust collected at different places in the facility should be measured periodically and logged to document responsible operation.

Acknowledgement

I thank my colleagues Dr. Irwin A. Taub, Mr. Robert D. Jarrett, Mr. Thomas G. Martin III, and Dr. Edward S. Josephson for their comments when proofreading the manuscript. One of their comments, which I fully agree with although it is not reflected in the body of this paper, is that much of the designs of the irradiation facilities and the calculations of irradiation geometries apply with only minor modifications to those using cesium-137 source instead of cobalt-60 source.

References

1. Artandi, C. (1964). Production experiences with radiation sterilization. *The Bulletin of the Parenteral Drug Association*, **18**, 2-9.
2. Artandi, C. (1967). Ethicon worldwide complex of ^{60}Co sterilization units. *Isotopes Radiation Technology*, **4**, 399-403
3. Kendra, E. (1970). Production experience in a cobalt-60 irradiation plant for sterilization of disposable medical products. *Chemical Engineering Progress Symposium Series 66 (106)*, 42-47.
4. Jefferson, S. (1964). Commissioning a gamma radiation processing plant. *Ionizing Radiation and the Sterilization of Medical Products*. Proceedings of the first international symposium organized by the Panel on Gamma and Electron Irradiation, December 6-9, 1964, Riso, Roskilde, the Research Establishment of the Danish Atomic Energy Commission. Taylor and Francis Ltd., pp. 109-111.
5. Brouqui, M., Eymery, R. and Saint-Lebe. (1973). Irradiateur de produits alimentaires en sacs. *Radiation Preservation of Food*. Proceedings of a symposium organized by IAEA and FAO of the United Nations and held in Bombay, November 13-17, 1972. IAEA, Vienna, STI/PUB/317, pp. 577-591.
6. Jarrett, R. D. (1967). U.S. Army Radiation Laboratory. *Advances in Chemistry Series 65*, American Chemical Society, pp. 156-170.
7. Dietz, G. R. (1964). Facilities supporting AEC food irradiation research. *Radiation Preservation of Food*. Proceedings of an international conference, Boston, Massachusetts, September 27-30, 1964. NAS/NRC publication 1273. Washington, DC (1965), pp. 303-313.
8. Manowitz, B., Bretton, R. H., Galanther, L. and Rizzo, F. X. (1964). *Computational Methods of Gamma Irradiator Design*. Brookhaven National Laboratory, Upton, New York, BNL-899 (T-361) (Isotopes — Industrial Technology — TID — 4500, 36th ed.) pp. 1-205.

9. Artandi, D., and Van Winkle, W., Jr. (1965). Comparison of electron-beam and gamma irradiation plants. *Isotopes and Radiation Technology*, **2**(4), 321-328.
10. Brynjolfsson, A. (1973). Factors influencing economic evaluation of irradiation processing. *Factors Influencing the Economical Application of Food Irradiation*. International Atomic Energy Agency, Vienna, IAEA-PL-433/2, pp. 13-35.
11. Gard, C. W. S., Warland, H. M. F. (1973). Factors influencing food irradiation economics. *Radiation Preservation of Food*. Proceedings of a symposium organized by IAEA and FAO of the United Nations and held in Bombay, November 13-17, 1972. IAEA STI/PUB/317, pp. 629-636.
12. Leveque, P. (1966). Considérations économiques sur le traitement par irradiation. *Food Irradiation*. Proceedings of a symposium organized by IAEA and FAO of the United Nations and held in Karlsruhe, June 6-10, 1966. IAEA STI/PUB/127, pp. 847-850.
13. Ghormley, J. A., Hachanadel, C. J. and Boyle, J. W. (1968). Yield of ozone in the pulse radiolysis of gaseous oxygen at very high dose rate. Use of this system as a dosimeter. ORNL-P-4089 and J. Chem. Phys. **50**, 419-423 (January 1, 1969).

The Prospects of Using Cesium For Radiosterilization

R. Eymery

Commissaria à l'énergie atomique, Centre d'Études Nucléaires de Grenoble, France.

Abstract: *The development of nuclear energy leads to the production in power reactors of large quantities of useful radioisotopes like cesium-137. Safety considerations have led to the construction of fission product separation facilities.*

Thus, during 1974 cesium-137 separated at Hanford will become available. No decisive technical argument can direct the choice between cesium-137 and its main competitor cobalt-60.

Although the present prices appear to be more or less artificial, the choice of cesium-137 could be economically justified, but the difference of cost compared with cobalt-60 is very small.

A decrease of the price announced for cesium-137 could lead to a significative development of its market.

Production Perspectives for Cesium-137

From the very first years of nuclear energy, it was apparent that the quantity of radioactive products that would be produced in nuclear power-reactors, would be considerable.

Among the numerous radioisotopes that occur in the fission of uranium-235 nucleus, one, cesium-137, emits a radiation with very interesting characteristics. It is comparatively abundant; nearly 6% of the uranium-235 nuclei give rise to cesium-137 atoms.

The expansion of electricity production of nuclear origin will lead in the course of years to the formation of quantities of Cesium-137 having no common measure with present consumption of radiation sources. Thus a single 1,000 MW power-reactor will produce about 3 MCi of cesium-137 each year.

As the decay of cesium-137 is very slow (2.5% per year) the available accumulated quantities in the year 2000 should attain some 30,000 MCi representing a radiation power of 100,000 kW, as compared to the total power of radiation sources used today for radiosterilization, of the order of 100 kW^{1,2}.

These perspectives — and there is no doubt today they will occur — led those responsible for atomic energy to initiate, as early as the 1950s, research programs on radiation applications.

Thus, considerable work was carried out on radiation chemistry, with the main object of finding some utilization for these enormous radiation sources. Sooner or later, in a world in which nuclear energy will be acquiring more and more importance, fission products will become more and more plentiful and it is very necessary that they be utilized by industry as in any case, these dangerous waste products cannot be eliminated by physical or chemical means. Dilution in the sea, sometimes used for short-lived radioactive wastes, would certainly be unacceptable for the quantities of cesium-137 now being produced. Dumping raises delicate problems, as dumping containers must offer all the seal-proof

guarantees required for many centuries. The 30,000 MCi just mentioned will still represent 30 MCi after 300 years of decay. cesium-137 is certainly not the only radioisotopic fission product creating problems, but it is indubitably one of the most troublesome because of its long half-life, the energy emitted and the considerable biological risk it represents as it fixes itself easily in the bones.

Utilization of cesium for industrial irradiation must be considered within this double prospect: an increasingly great and inevitable abundance of this radiation source, an advantage in its utilization as radiation source, that corresponds, in fact, to storage under permanent supervision.

But as it is hardly possible to utilize non-separated fission products, some fairly expensive research has been carried out to isolate cesium-137 and a few other interesting isotopes, such as strontium-90, from the other fission products.

Separation Programs for Cesium-137

To our knowledge, only two countries have developed the study of the separation of fission products to the level of industrial production: the United States and France.

American program

It rests on two teams with somewhat different objectives:

- On the one hand, the Isotopes Development Center at Oak Ridge has been engaged since 1954 in making available to potential utilizers the isotopes that industry could not supply, and in particular cesium-137.
- On the other, the Hanford laboratories, specialized in the re-treatment of nuclear fuels were early led to study the separation of cesium-137 on a major scale, as much as part of the general problem of the treatment of fission products, as for commercial purposes.

Several methods of separation, resting essentially on mineral ion exchangers, have been studied. The alumino-silicate system is extremely effective cesium can be obtained in the form of chloride and eventually be converted into an insoluble compound (cesium glass).

About 1965, the ISOICHEM Company was established, with private capital, to build a plant in Hanford for the use of this technique. A production of 30 MCi of cesium-137 per year, was foreseen.

The program rested entirely on the possibilities of commercializing the extracted products: cesium-137, promethium-147, strontium-90. The price indicated was 12.5 ¢/Ci for cesium-137, which just brought it to a competitive level with cobalt-60. The sales of radioisotopes in 1966 and 1967 clearly proved that the ISOICHEM project was established on forecasts that were too optimistic both as concerns cesium-137 as well as the other radioisotopes of the program.

The project of the private plant for the separation of fission products was therefore given up, and the AEC continued to produce cesium-137 on a moderate scale (less than one MCi per year) in its Oak Ridge laboratory.

With the disappearance of the ISOICHEM project, the whole problem of the fate of high activity wastes remained. The separation of cesium-137 to allow its storage, isolate from the other radioelements, is the subject of studies by Battelle North-West at Hanford; the interest in using the cesium as a radiation source then went into the background. The object of the present Hanford Waste Management Program project is the conditioning of cesium chloride melted in containers of 2.6 inches

outside diameter. This seems to be the most suitable dimension for storage containers.

As we shall see further on, it leads to a high self-absorption of radiation. An economic study would have led to the realization that smaller diameter sources would entail an increase in the cost of sources greater than the economy obtained by the reduction of self-absorption³.

The establishment of separation and conditioning plants is being continued; it was considered that industrial scale manufacturing would start at the beginning of 1974.

Although this program is essentially intended for the conditioning of cumbersome wastes that are in storage at present, it is obvious that it will be possible to use the same technique in the future for the conditioning of cesium produced in power reactors. It is also possible that from a financial point of view, fission products produced in power reactors will be more interesting. That is because they contain a fairly high quantity of cesium-134 which emits more energy than cesium-137, with however a faster decay rate.

French program

The quantities of fission products stored in France are considerably less than the quantities stored in the United States; the problem of their final conditioning therefore has no urgency. Nevertheless in consideration of the perspectives of development of the irradiation market, a separation and conditioning program was initiated at the beginning of the 1960s.

A pilot separation and conditioning plant was commissioned in 1971. More than 500,000 Ci were separated that year. Unfortunately, the sale price restricted the use of cesium, both in Europe and in the United States, solely to laboratory irradiators and to mobile irradiators⁴.

The French separation unit was stopped at the beginning of 1972.

Technical Comparison of Cesium-137 and Cobalt-60

Nuclear characteristics

Table I summarizes the nuclear characteristics of cesium-137 and cobalt-60. As will be seen, we have also shown those of cesium-134. This is because this last is also a fission product and it is not possible to separate one from the other. The cesium-134 content in relation to cesium-137 depends on the length of stay of the fuel in the reactor and the time elapsed since its withdrawal from the reactor.

It can happen that the quantity of cesium-134 is of the same order as that of cesium-137.

The use of the cesium-137: cesium-134 mixture for irradiation can be considered.

Radiation penetration

The energy of the photons emitted by cesium-137 is markedly less than that of cobalt-60 photons. Now, the effective sections of absorption vary appreciably with energy. It could therefore be considered that the radiation emitted by the cesium would be attenuated much more quickly and that consequently it would be more difficult to ensure a comparatively uniform irradiation.

Table I. — Radioactive properties

	Cs-134	Cs-137	Co-60
Half-life, yr	2.10	30.2	5.26

Decay Energy			
W/Ci			
Gamma	9.48×10^{-3}	3.35×10^{-3}	14.9×10^{-3}
Beta	0.85×10^{-3}	1.0×10^{-3}	0.56×10^{-3}

Decay energy spectrum (Gamma)

Cs-134		Cs-137		Co-60	
MeV	%	MeV	%	MeV	%
1.40	0.1				
1.365	3.0			1.3325	100
1.168	1.85			1.1732	100
1.039	1.06				
0.802	9.5				
0.796	89.0				
0.605	98.0	0.6616	85.00		
0.569	15.8				
0.563	8.82	0.032	5.82		
0.475	1.54	0.0365	1.31		

Actually, we find that in media that essentially contain materials of low atomic number, the diffusion phenomena are extremely important, and the dose received is due more to the photons that have been subjected to diffusions, rather than to the photons coming directly from the source.

In radiosterilization installations, the attenuation of cesium-137 radiation is of the same order as that of cobalt. This can be seen on the attenuation graphs in Figure 1, drawn up according to reference 5 and 6.

If the cesium sources offered the same self-absorption as the cobalt sources, some could undoubtedly be placed in existing industrial irradiators, without any major change to the latter.

Specific activity and self-absorption problems

Whereas the specific activity of cobalt-60 depends on the time it stays in the reactor and varies, for industrial sources, from 5 to 100 Ci/g, that of cesium-137, when it is separated, depends mainly on the time elapsed after coming out of the reactor; in practice it varies from 20 to 25 Ci/g. As the power emitted by 1 Ci of cesium-137 is about a quarter of that of 1 Ci of cobalt-60, it can be seen that a cesium source, at equal power, may weigh 10 or even 20 times more than a cobalt source. If therefore one wishes with a certain number of elementary sources, to obtain a specific radiated power, the cesium-137 sources will be heavier and will absorb their own radiation in a bigger proportion (35 to 40% of self-absorption for cesium-137 sources of two inches diameter instead of 8 to 20% for equivalent cobalt-60 sources). Self-absorbed radiation produces heating of the sources. In most cases, the total power dissipated in this way will not exceed a few kilowatts and will not cause too high a rise in temperature.

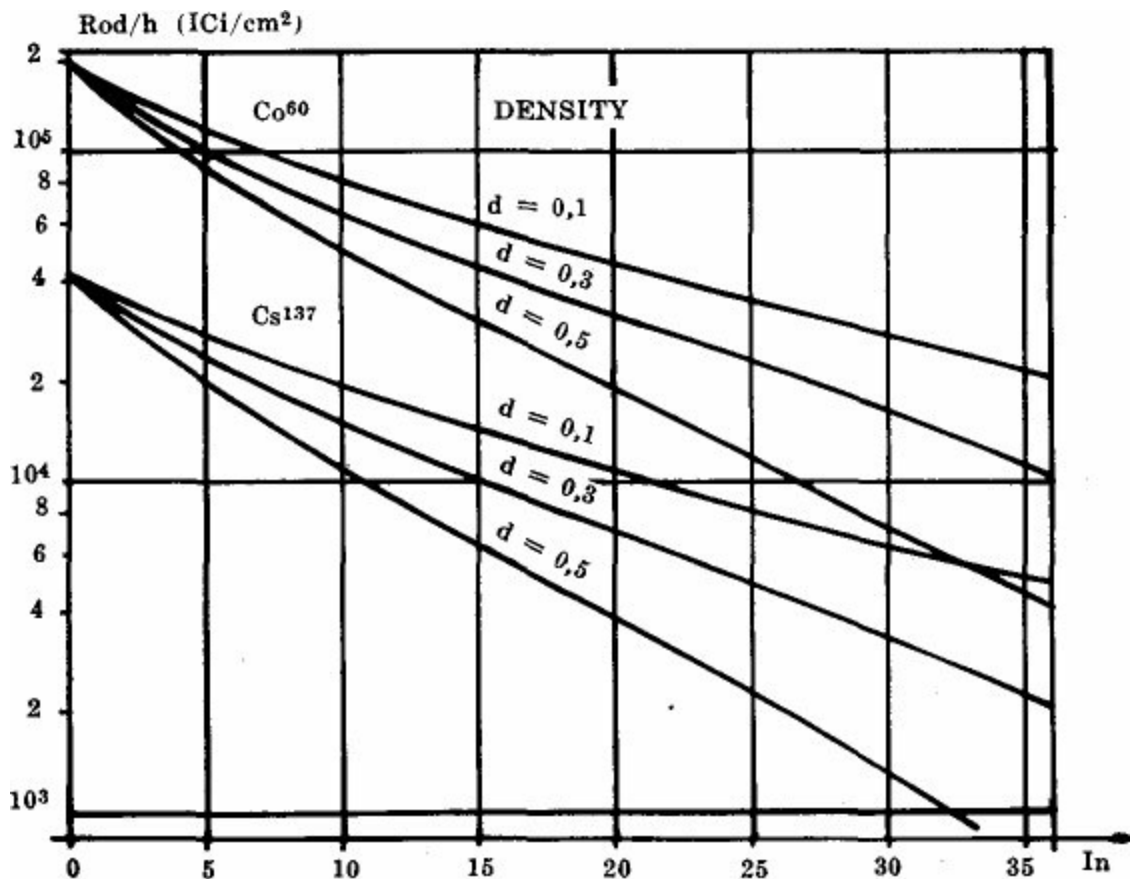

Figure 1. Depth dose. (air gap: 2", Square Slab Source 60" × 60")^{5,6}.

On the other hand, it can be asked if the necessity of storing a more considerable mass of radioactive materials on the source-rack will not give rise to some difficulties.

Actually, a 4 MCi source of cesium-137, of approximately equivalent energy to a 1 MCi source of cobalt-60, represents a volume of 62,500 cm³. If it was possible to spread the cesium evenly on a 2 m × 2 m slab, the source would have a thickness of 1.56 cm. As there is no need to leave much space available for later rechargings, the realization of an industrial cesium irradiator does not meet with any important difficulties from that point of view.

Conditioning — Safety

Whatever the radioisotope considered, it is considered that a double sheath in stainless steel presents all necessary guarantees against contamination risks. Some cobalt sources have now remained for twenty years in such arrangements and the major part of this time has been spent under water.

For cesium sources, we do not have as long an experience but such examinations as have been carried out prove that the cesium capsules can be stored equally well.

On the other hand, measurements carried out with sources intentionally pierced with very small holes (30 μm in diameter) show that activity diffusion to the outside, even in water, is extremely slow⁷ in spite of the high solubility of cesium chloride. This high solubility has an advantage however. It makes decontamination, after an eventual accident, much easier.

Finally on a last point, the thickness of the shielding required, cesium-137 has a distinct advantage over cobalt-60. Actually only 1.20 m of concrete is required instead of 1.70 m, or 18 cm of lead instead of 34 cm. This is subject to the cesium-137 not containing cesium-134, that is to say that it has been out of the reactor for a sufficiently long time.

Shielding apart, the technological problems created by the use of a mixture of cesium-137 and cesium-134, are the same as those created by cesium-137 alone.

Dimensions of the unit sources

In a gamma irradiation plant, it is necessary that the irradiated packages receive doses presenting a certain uniformity. This uniformity can be more easily obtained if a large number of elementary sources are available that can be arranged on the source-rack.

The sources produced at Hanford will contain 60,000 Ci of cesium-137.

For the initial charging of an irradiator, which could be of the order of 400,000 Ci at least, six Hanford type sources must therefore be available, and satisfactory uniformity could probably be obtained by alternating the position of the six sources.

On the other hand, when recharging, for example after five years of utilization, the quantity to be added will also be of the order of 60,000 Ci. The setting in place of this single source, with a different activity from that of the other sources, could appreciably complicate the choice of a satisfactory arrangement for the sources, to obtain uniformity in the dose.

It could become necessary perhaps to utilize special sources, with a weaker activity.

Economic Comparison

As we have just seen, no decisive technical argument can direct the choice between cesium-137 and cobalt-60. At the most, it may be feared that the authorities responsible for security may fear contamination by cesium somewhat more than by cobalt.

Is it possible to make a valid economic comparison?

Price of Cobalt-60 sources

For a number of years, transactions in cobalt-60 have been carried out at prices in the neighbourhood of 40¢ US per curie. Such a stability could lead one to think that there exists a real market price, determined by technical and economic considerations. Actually two important remarks must be made:

The first is that the theoretical production capacity of cobalt-60 has no common measure with the present market for these products. Thus the neutron irradiation reactors, such as those of Savannah River, have production capacities that amount to some tens of megacuries per year, and the Pickering power reactors in Canada, the first of which has been put into service, will actually each produce 5 MCi per year, whereas the present world market for cobalt is of the same order.

The second remark is that the market for cobalt-60 is at present mainly dominated by a single producer: AECL. For Canada, cobalt-60 is therefore a by-product which is or may become considerably superabundant; its present price is somewhat fictitious. Development of the market and a different estimate of production costs could lead to major variations in the price.

Sale price of Cesium-137

When the ISOICHEM project we have already mentioned was prepared, the AEC decided, for promotion reasons, to reduce the price of cesium-137 to 12.5 ¢ per curie.

As far as we know, there have been no deliveries so far of Hanford produced sources, but it had

been announced⁸ that these sources would be sold, sealed, at 10 ¢/Ci.

Here again, it may perhaps be useful to stress that this price was set without reference to the actual cost of separation and conditioning. Taking the experience acquired at its fission products separation unit at La Hague into account, the Commissariat à l'Énergie Atomique (France) has been able to work out estimates of the cost price of separation and conditioning. For a production of 0.5 MCi per year, the production cost price reaches more than \$1 US per curie. In this cost, fixed charges make up nearly 80%; it is therefore obvious that a major reduction of cost price could be obtained with a unit of very big dimensions. Extrapolation to a unit of 10 MCi per year leads to a price of 15 to 20 ¢/Ci.

Comparison of treatment cost prices for industrial plants

As we have just seen, various hypotheses can be made as to the evolution of prices in the future and as to the part each of the isotopes considered may have in the market.

We would like to put the problem now in an immediate and practical way: in 1974 it is possible in principle to choose between cobalt at 40 ¢/Ci, cesium-137 conditioned by Hanford at 10 ¢/Ci, and cesium-137 purchased at Hanford but reconditioned to a form better adapted for industrial irradiation.

The cost price of a cubic meter radiosterilized to 2.5 Mrad, has been calculated for outputs per hour extending from 0.5 to 3 cubic meters.

These plants are assumed to be located in Western Europe, but for reason of convenience, the costs have been worked out in US \$.

The initial cost of the plant is written off over ten years, with an interest of 14%.

Two types of installation have been considered. The first (type A) corresponds to a medium efficiency and a fairly modest investment in irradiation mechanisms (two passes, batch thickness 50 cm, over-dosage 1.35).

The other (type B) corresponds to a more complicated mechanical lay-out, allowing a higher efficiency to be obtained (4 passes on either side of the source, 55 cm batches, overdosage 1.35). The mechanical lay-out adopted is the same for a given type whatever the source, but owing to self-absorption and slight differences in radiation attenuation, the efficiency obtained varies with the type of source.

Among the hypotheses made, we must also draw attention to an estimate of the cost of transport USA-Europe of \$6000 for a charge of 400,000 Ci and a reconditioning cost of \$800 per elementary source whatever its activity. Finally it has been assumed that recharging would take place annually in the case of cobalt-60 and every 5 years in the case of cesium-137.

The results we obtained for 0.5 - 1.5 and 3 cubic meters/hour are shown on the Table II. The cost prices indicated included amortization and operating expenses except labor which is the same in every case and will depend on the country and on the company organization. We have shown independently the cost related to the source (amortization and replenishment) and the building and mechanism amortization.

Table II. — Cost of radiosterilisation (U.S. \$)

Type of Plant		Medium Efficiency Plant				Very High Efficiency Plant			
Type of Source		Cobalt-60	Cs-137 Ø = 2	Cs-137 Ø = 3	Cs-137 Hanford	Cobalt-60	Cs-137 Ø = 2	Cs-137 Ø = 3	Cs-137 Hanford
Output	Efficiency (density 0.2)	30%	33%	29%	26%	56%	54%	47%	41%
	Initial investment (US. \$)	298 000	374 000	347 600	322 100	370 000	413 000	405 500	390 000
0.5	Annual cost:								
m ³ /h	— Facility	44 800	44 800	44 800	44 800	64 000	64 000	64 000	64 000
	— Source	24 900	30 900	26 800	21 600	16 900	20 600	18 700	15 200
	— Total (except manpower)	69 700	75 700	71 600	66 400	80 900	84 600	82 700	79 200
	COST PER CUBIC METER [US.\$] (except manpower)	17.4	18.7	17.9	16.6	20.2	21.1	20.7	19.8
	Initial investment (US. \$)	453 000	657 000	602 900	532 300	444 000	590 000	558 100	523 900
1.5	Annual cost:								
m ³ /h	— Facility	44 800	44 800	44 800	44 800	64 000	64 000	64 000	64 000
	— Source	68 500	87 900	75 100	62 600	38 000	55 200	47 500	41 400
	— TOTAL (except manpower)	113 300	132 700	119 900	107 400	102 000	119 200	111 500	105 400
	COST PER CUBIC METER [US. \$] (except manpower)	9.4	11.1	10.0	8.9	8.5	9.9	9.3	8.8
	Initial investment (US. \$)	683 000	1 084 000	985 000	844 600	568 000	849 000	795 800	721 800
3	Annual cost:								
m ³ /h	— Facility	44 800	44 800	44 800	44 800	64 000	64 000	64 000	64 000
	— Source	133 300	174 300	149 800	125 300	72 900	106 000	92 500	80 100
	— TOTAL (except manpower)	178 100	219 100	194 600	170 100	136 900	170 000	156 500	144 100
	COST PER CUBIC METER [US. \$] (except manpower)	7.4	9.2	8.1	7.1	5.7	7.1	6.5	6.0

It can be seen that the cost prices obtained are extremely close and that, under the hypotheses made, there does not appear to be any economic interest in reconditioning the cesium taken as delivered by Hanford in sources of 2.6" diameter. On the other hand, it may be necessary to do so for technical reasons.

These results must be compared to the study carried out by Battelle North-West⁹ which led to a competitive price, as compared to cobalt-60 (at 40 ¢/Ci), of 11 ¢/Ci for cesium-137 conditioned in sources of 1" diameter, and of 8 ¢/Ci for cesium delivered in the 2.6" diameter containers produced at Hanford. Considering the difficulty arising out of this type of economic assessment and the agreement between the conclusions of two independent studies carried out differently, it can be admitted that at a price level of approximately 10 ¢/Ci, the cesium-137 produced at Hanford is at the competitive limit with cobalt-60 at 40 ¢/Ci.

Eventual utilization of the mixture Cesium-137/Cesium-134

The presence of cesium-134 mixed with the cesium-137 in the fission products of power reactors allows for sources of higher specific power.

The presence of two isotopes of different periods seriously complicates calculations on recharging and consequently the evaluation of cost prices. The quantity of cesium-134 associated with 1 Ci of cesium-137 is usually between 0.6 and 1.2 Ci for fission products that have come out of a power reactor for less than a year. The additional energy contained in the cesium-134 brings the competitive price of the cesium-137 curie to a level of the order of 25 ¢/Ci, always as compared to a curie of cobalt-60 at 40 ¢⁹.

Consequently, it is not to be denied that the mixture possesses sufficiently attractive economic characteristics for its separation to be considered.

According to the results obtained in the commercialization of cesium-137 conditioned at Hanford, commercialization which is due to begin in 1974, it is possible that the mixture cesium-137/cesium-134 will be commercialized under interesting economic conditions, towards 1980.

Conclusions, Market Prospects

It is known that the applications of radiation in the chemical industry or for the preservation of foodstuffs, have not developed as much as was hoped. For the time being, radiosterilization forms the bulk of the industrial gamma irradiation market. A study of this market was carried out for USAEC¹⁰. It leads to an annual consumption equivalent to 16 MCi of cobalt-60 in 1980 and 29 MCi in 1985, in the most pessimistic hypothesis.

The division of the market between two or even three radioisotopes of different half-lives, makes any assessment difficult and uncertain.

The hypotheses made lead to the assumption that the cesium-137 capsule-sealed in Hanford could take half the market of radiation sources sold in 1980, that is about 25 MCi of cesium-137 per year⁹. These hypotheses appear to us to be somewhat optimistic.

The commissioning of the Hanford capsule-sealing plant for cesium-137 will, in the coming years, offer an alternative to cobalt-60. When studies of industrial irradiators utilizing cesium-137 will have been completed, when major plants will have been added to the present modest installations, it is not impossible that cesium will then appear as the radiation source of the future.

It is still presumptuous to assert it today.

References

1. Culler, F. L., Blomeke, J. O. and Belter, W. G. Current developments in long-term radioactive waste management. *Peaceful uses of atomic energy, AIEA*, (Geneva 1971) **11**, 427.
2. Sousselier, Y., Pradel, J. La gestion des déchets radioactifs et leur stockage à long terme. *Peaceful uses of atomic energy, AIEA*, (Geneva 1971), **11**, 445.
3. Van Tuyt, H. H., Stidham, H. C. and Keder, W. E. Encapsulated waste management cesium as a process radiation source. In: BNWL-1308-4, p. 6.
4. Courouble, J. M. and Rozand, L., Elan IIB. Atelier pilote pour la fabrication de sources de caesium. *Energie Nucléaire* 10:5 (Septembre 1968), pp. 297-302.
5. Rizzo, F. X., Galanter, L. and Krishnamurthy, K. Tabulated dose distribution data for gamma irradiator design. I. Cobalt 60 square plaque sources. *Int. J. Radiation Engineering (Israël)* (1971), 1(1), pp. 15-48. Also: Computational methods of gamma Irradiator design (BNL 899).
6. Rizzo, F. X., Galanter, L. and Krishnamurthy, K. Tabulated dose distribution data for gamma irradiator design II. Cesium 137 square plaque sources. *Int. J. Radiation Engineering (Israël)* (1971), 1(2), pp. 115-148. Also: Computational methods of gamma irradiator design (BNL 899).
7. Robinson, R. A. Safety aspects of Cesium 137 gamma radiation sources. *Transactions of the American Nuclear Society Meeting*, November 1972, pp. 692-693.
8. Radioisotope report, July 1972, p. 139.
9. MacKee, R. W. and Cusack, J. H. Technical, economic and policy considerations affecting future production, marketing and use of Cesium 137 and Strontium 90. December 1972. BNWL-1686.
10. Wood, P. M. and Harrel, H. A. Potential market for by-product cesium from commercial reactors. January 1971, AECOP-754 (official use only).

Panel

Questions and Answers

To L. B. SZTANYIK—Austria, by: H. B. RAINEY—New Zealand

Q. Could you please repeat the estimated savings in trained staff by the use of sterile disposables in hospitals? Was it 50 hours/week/bed at a usage rate of 70-80% presterilized disposables?

A. No, it was said that by the use of disposables, approximately 50 hours per year, per bed, could be saved.

To S. VASSERMAN — USSR, by: S. E. HUNT — U.K.

Q. Does 1.5 MeV represent the upper energy limit of your machines (ELIT 2) and are you intending to develop machines of higher energy? 1.5 MeV is rather limited for sterilization work.

A. We do not plan to develop ELIT machinery above 2 megavolts, although this is possible. The same type transformer of power supply has been used in special machines (field emission type) at voltages up to 5 megavolts.

To W. RAMLER — USA, by: S. E. HUNT — U.K.

Q. On assessing the relative cost of cobalt-60 radiation and the use of Dynamitron™, Dr. Ramler considers that the Dynamitron™, as a producer of bremsstrahlung only, and obtained roughly comparable economics. If we consider the Dynamitron™ or other electron accelerators as a source of electrons for direct electron sterilization, its economics should look even better.

A. I would simply say that I think you have to review the entire problem of sterilization and the approximate dose rate to appreciate and truly see if the overall economics, that is the economic cycle, is still intact as far as the process is concerned. I don't know what else to say at this point but this should be a point of discussion later on this afternoon.

To G. D. STEPANOV — USSR, by: S. V. NABLO — USA

Q. Could you comment on the number of linacs being used for radiation sterilization in the USSR. What products are usually sterilized with this type of source in the Soviet Union?

A. We have 5 linear accelerators. Accelerators are used for sterilization of medical devices, typically syringes, catheters, blood transfusion systems and materials in contact with blood.

To R. EYMERY — France, by: D. M. RICHMAN — USA

Can you clarify why scattering helps in giving cesium-137 a depth dose curve and hence irradiation of target uniformity closer to cobalt-60 than one might expect, and yet, when it comes to shielding, cesium is still much easier to shield. Doesn't scattering affect the penetration of the shield as well?

When you have an interaction of a photon with an atom, you may have essentially a Compton scattering or a photoelectric effect. In the photoelectric effect, the photon is absorbed. In the Compton effect, the photon is scattered with a lower energy.

Now, the probability of Compton scattering is more important with low atomic number material like medical products, the photoelectric effect being almost non-existent. Thus at 20 or 50 centimeters from the source, the dose-rate is mainly due to scattered photons, their number vary the same way for a cobalt source as for a cesium source.

In the shielding, however, the photoelectric effect becomes more important at low energy, especially in lead. Even in concrete, cesium photons which have undergone many scatterings will have a low energy and will be absorbed by photoelectric effect. Cobalt photons, after the same number of scatterings will have a higher energy and may not be absorbed.

To R. EMERY — France, by: H. M. F. WARLAND — Canada

Any cesium-134 in cesium-137 source would make dose control quite difficult particularly at the time of adding sources.

In fact the dose distribution with cobalt-60, cesium-137 and Cesium-134 is almost the same. Concerning the decay, it is not difficult to calculate it, if you know the ratio of cesium-134 to cesium-137. I think it is possible to take account of the fact that the specific activity of some new sources will vary more rapidly than the specific activity of others.

To R. EYMERY — France, by: H. M. F. WARLAND — Canada

I think that it is necessary to assume a finite capsule life in your source cost calculations. 15 to 20 years would seem a reasonable maximum. Please comment.

In my calculations, I have taken, as it is usual, a ten year amortization period, that means that I suppose the source is worth nothing after 10 years. From the safety point of view, however, I think that the sources cobalt, or cesium, should be sent back to the producer after 20 or 30 years. I cannot imagine that it will be allowed to keep in a facility sources a hundred years old.

To A. BRYNJOLFSSON — USA, by: W. BARNES — U.K.

Your paper made no mention of cobalt-60 plants with a dry safety cell. As downtime, not actual time, spent in loading can be as long as 36 to 48 hours when refuelling a plant with a wet safety

Q. pit compared with 2 hours to refuel a plant with a dry safety pit. Would you give your opinions on these two systems of safety?

A. In small facilities, less than 40,000 - 60,000 Ci, the dissipation of heat is usually not a problem and one may use a dry cell. If the source is large (for example 500,000 Ci or more) the heat and the radiation from a source may disintegrate the concrete shielding. I would then be inclined to favor a wet storage or safety pool. I believe it is misleading to talk about refueling time of 2 hours for small industrial Co-60 facility. These facilities are likely to have a dwell-time of the product in the irradiation cell in the order of a day or even several days. It would be difficult to change the activity or to reload the source with product inside the irradiation room. I see no reason why the reloading time should be different in facilities with dry and wet safety pit.

To J. HAIMSON — USA, by: W. W. VINCENT — U.K.

Q. With the present state of the technology given a low density of 0.6 gram per cc, would it be possible to give some indication of the sterilizing output range over which linac accelerator costs are more favorable than gamma radiation?

A. Let us assume your 0.6 g/cc product is packaged so that the maximum advantage can be gained from either system. This will result in an overall utilization efficiency of 30 to 33% for the ⁶⁰Co irradiator and 50 to 55% for a correctly designed high energy electron linear accelerator. For a standard 10 MeV, 10 kW machine, this would require a product thickness of 5 cm. The equivalent ⁶⁰Co irradiator would require 1.0 to 1.1 megacurie and both systems would then be capable of 600 kg/hr. throughput at a dose of 3 Mrads.

A. The capital costs and housing costs are comparable for both systems, and the conveyor costs favour the machine installation. The annual replacement cost of ⁶⁰Co is considerably higher than the operational costs of a 10 MeV, 10 kW modern linear accelerator but this tends to be offset by the lower availability factor of the machine (92 to 96%) compared to the irradiator (97 to 99%)*. From this and other operational evidence I believe that for above 500 kg/hr. (at 3 Mrad) modern linear accelerators are more favorable than ⁶⁰Co irradiators.

To L. B. SZTANYIK - Austria, by: C. B. G. TAYLOR — U.K.

Q. You mention the possibility of sterilizing blood components by irradiation. For example, for the control of serum hepatitis. Please say where work on this problem is being done? Is the blood component processed in any way after irradiation to remove the product or damage?

A. As an international civil servant, I don't wish to seem a nationalist. Therefore, I did not wish to mention among the countries, Hungary first. We decided to list the authors of papers which have been published and according to this list, put in alphabetical order, the first author who had to be mentioned is Antoni of Hungary, then Gergely from Hungary, Frisehauf from Austria and Martinez de Alva from Mexico who were looking for the possibility of sterilization of blood

components by using irradiation. All these experiments were carried out in live-life form and no appearance of toxic products has been reported in this paper. The paper can be found in an agency publication called: Radiosterilization of Medical Products; that is a symposium proceeding published in 1967 and another paper published in 1969: "Sterilization and Preservation of Biological Tissues by Ionizing Irradiation".

To R. EYMERY — France, by: S. E. HUNT — U.K.

The production of fission product waste is one of the main problems connected with the expanding nuclear energy program. Is this not an argument for immediately storing them in leak-free storage cylinders under carefully controlled conditions rather than attempting to separate them and use them industrially and thus increasing the risk involved, particularly in the case of long-lived bone seekers, such as cesium-137.

Q.

I cannot answer in the name of the USAEC which manages this waste separation program. I suppose that it would be inefficient to store together products with short half life and products with long half-life, high and low activity wastes, alpha emitters with gamma emitters which require remote handling.

A.

The fact is that cesium-137 from the waste management facility will be available this year. The contamination risk is probably easier to control in an irradiation facility than elsewhere.

To J. HAIMSON — USA, by: Z. P. ZAGORSKI — Poland

You have mentioned troubles with handling boxes for irradiation. I have the feeling that accelerators are more advanced nowadays in comparison to other hardware around the machine. Would you mind expressing your opinion about the optimal construction of a conveyor?

Q.

Because of the high throughput capability of linear accelerators, special attention should be given to the logistics of product handling — the loading, unloading and staging area as well as the conveyor system.

Unlike the gamma irradiator, the linear accelerator provides a concentrated beam of high intensity radiation and this allows the use of a simple, single-pass conveyor system. Since the electron beam can be scanned in the transverse direction many times during the time the product moves forward a distance equal to the width of the beam, the dose uniformity can be controlled to a high degree of accuracy.

A.

The conveyor system may be of the product carrier type, mounted from the ceiling, and used with a horizontal beam, or the belt and roller type which passes beneath a vertically downward directed beam. In the construction of conveyor systems, care should be taken to select radiation and corrosion resistant materials such as stainless steel belts or product carriers.

I tend to favour the product carrier conveyor system because all the critical components are remote from the beam and because it allows the use of a vertical plane electron window.

To G. D. STEPANOV — USSR, by: R. S. M. FROHNSDORFF — U.K.

Q. How much cobalt-60 is there in the gamma radiation plant described? Is this the only commercial gamma facility in the Soviet Union?

A. Yes, it is the only installation of this type. The activity of the irradiator is one million curies.

To A. S. IVANOV — USSR, by: S. V. NABLO — USA

Q. Would you comment on the relative economics of using very large “self shields” as you described for the Elektron-3 accelerator, as compared with the use of vaults or “volume shield” rooms. Doesn't such a large shield weight limit the use of the accelerator?

A. If the shields contain concrete, the economics are as follows: At this time, the accelerator has dimensions 1.5m × 3m × 3.5m, a vault would have dimensions of about 6m × 3m × 10m. These are minimum dimensions. With the self shielded accelerator, there is a savings of about 20,000 dollars per installation.

To A. S. IVANOV — USSR, by: S. V. NABLO — USA

Q. Has such Elektron 1.1 meter units been used for industrial sterilization in the Soviet Union?

A. It is used to irradiate polyethylene and transparent plastics.

To G. D. STEPANOV — USSR, by: T. OUWERKERK — Netherlands

Q. There is a design of an irradiator made for sterilization purposes using the gamma irradiation from a cooling medium of a cooling powered reactor. This medium is a liquid metal with a high cross section and a short half life. Will this design be applied, that is, is it being used now? A. No, we feel that this principle is too complicated.

To A. BRYNJOLFSSON — USA, by: H. M. F. WARLAND — Canada

Q. Would you please define efficiency as shown on the slides. Is it based on curie contents or output from the source, and is it based on minimum or average dose in the product?

A. My definition of the irradiation efficiency is fully described in the text of my paper. I have assumed uniform product density, no spacing between boxes or inside the boxes. The efficiency shown in Table II does not include the down-time nor the time lost, when changing to a new product; nor does it include holes or spacing between the packages. Therefore, the efficiency reported in Table II represents maximum efficiency and should be used as a guideline only.

To W. RAMLER — USA, by: H. ROUSHDY — Egypt

As expected, developing countries are keen to make best of their imported technical facilities. Do you recommend any specific model of electron linac accelerator of variable energy which can

Q. fulfill low energy beam requirements for modification of characteristics of textile material, moderate energy beam required for irradiation sterilization of medical supplies, and the high energy beam required for plasma physics studies? Furthermore, is there any possibility for utilizing such industrial plants in electron therapy?

First of all the aspect of a wide range of use quite often what comes into question is pulse repeatability of characteristics in regard to both energy and current. One should start looking at electrostatic machines. This would give you a wide range of energy variations. It will certainly give you pulse characteristics that are conducive to reaction connected studies. But, in the next breath, I simply say, well here we come to the question of what should be the throughput associated with the machine and then one has to go back and relate to the other machines, such as the ICT, the Dynamitron™ where there is a high power consideration. Many of these machines, the ICT, the Dynamitron™ certainly have the repeatability of characteristics and the question comes up then, just what do you really want as far as throughput from the machine is concerned? So I guess what I'm trying to say — well let me say one other thing. The one other thing is the linac — a very beautiful machine too — because you can run with the injector system, you can drift the beam through the structure, so that you can run a wide range of energy; obtain some very nice pulse characteristics, either the micro second type pulsing condition or into even the nano, even the pico-second range, if you want to push that hard from the research standpoint. So there never is a clear cut answer to this until you put some notes on paper. What is the number you want to see come out of this machine? Now as far as the therapy aspect is concerned, if you really relate to the quality of your beam, meaning not only the physical size, but the diversions and the energy repeatability and the current, etc. — I would certainly say that one could relate to the therapy side of the picture with such a machine. Possibly there are more questions about that, but that is my attempt to try to answer them.

A.

To R. EYMERY — France, by: S. V. NABLO — USA

You commented on the shield economics of cesium-137 irradiators for portable applications. Do any of the mobile or portable applications look promising and are some planned in France in the near future?

Q.

A. Mobile or portable irradiators are used only for demonstration purposes. We do not intend to build another one in France.

To S. VASSERMAN, A. S. IVANOV and G. D. STEPANOV — USSR, by: T. OUWERKERK — Netherlands

Q. In Novosibirsk you developed transformers for industrial use and as far as I know, your colleagues developed linac types of accelerators in Leningrad and your colleagues in Minsk are using Co-60 sources for sterilization work. Can you give us an impression of the type of irradiation equipment that will be likely used in the USSR for sterilization work in the near future?

A. The choice of the most efficient radiation sterilization system is dependent upon a number of factors: product thickness, plant capacity, product sensitivity and dose rate required, capital and operating costs, etc. Therefore, one type of radiation sterilization machine, or even two, could not satisfy the diverse requirements of this industry.

To J. HAIMSON — USA, by: K. H. MORGANSTERN — USA

Q. The approximate capital cost of a 6 megavolt, 30 kilowatts linac is what? What is the approximate operating cost excluding amortization?

A. The approximate cost of a 6 MeV. or 10 MeV., 30 kW. linac is between 750,000 and 900,000 dollars. Its operating cost is somewhat between 40,000 and 70,000 dollars a year, depending on the operating staff and spare parts contingencies.

To The Panel, by: A. CHARLESBY — U.K.

Q. How does the panel view possible uses of strontium-90 for treatment of thin objects with low shielding needs and corresponding low cost for small specialized sources?

by: R. EYMERY — France

A. Strontium needs almost the same shielding as cobalt or cesium because you have a photon which is quite important. Secondly, those rads that we can expect from strontium are a few megarads per hour. The capacity of sterilization by strontium, even with a very large source is rather small.

To A. BRYNJOLFSSON — USA, by I. GALATEANU — Romania

Q. What are the trends in the market concerning sales of cobalt irradiators as compared with those of accelerators. Are these competitive and will accelerators replace in any way cobalt-60 irradiators, especially in mobile sources?

A. I believe both radiation sources have their place. When deep penetration is needed, a cobalt-60 source should be used. As Dr. Morganstern pointed out, the cost of X-rays from DC accelerators may be comparable to the cost of gamma rays from Co-60. I favor the electron accelerators for large product throughputs, requiring irradiation sources of 10 kwatts or more, if the penetration depth of the electrons is adequate.

To L. B. SZTANYIK — Austria, by: H. ROUSHDY — Egypt

Q. You mentioned an alleged radiosensitivity of virus due to change in temperature during irradiation. Does radiation damage on virus follow a more or less dose effect relationship? If so, is there any experimentation you would kindly refer to?

The two more comprehensive publications I may recommend are:

A. Sullivan *et al* — Appl. Microbiol 22: 61-65 1971 and Pollard — Manual on Radiation

To S. VASSERMAN — USSR, by: W. L. McLAUGHLIN — USA.

Will you say a few more words about the following?

1. Typical frequency of maintenance and downtime for transformer type pulsed accelerators.

Q.

2. Typical beam handling system i.e. dimensions of scanner, window, etc.

3. Typical product dwell times for administering a reasonably uniform dose of, say, 2.5 megarads with the Elit 2 accelerator operating at full power.

1. At the present time the limiting factor in maintenance is the electron gun which must be serviced at intervals of about two hundred hours. Our goal is to improve overall system reliability so that preventative maintenance is required at not less than 500 hour periods. Downtime for preventative maintenance is one shift (8 hours).

A.

2. We now use two window sizes on our scanners: 80 mm × 500 mm and 100 mm × 1200 mm. For special applications, scanners with widths of 2 meters have been produced. We normally use a scan angle of $\pm 25^\circ$. Scanning systems have been developed which permit tailoring of the pulse distribution or overall current distribution of the system.

3. For a 1M × 10 kW. system at 1.5 Megavolts, line speeds would be 3 m/min. for a 2.5 Megarad dose; this would give an exposure time of ~ 1 sec.

To S. VASSERMAN — USSR, by: I. GALATEANU — Romania

1. If the accelerator ELIT-2 will be commercialized, what is the price?

Q.

2. What is the irradiation capacity of ELIT-2 for sterilization of medical products?

3. What is the cost of operation of 1000 Kg. material irradiated?

1. This family of accelerators is being manufactured at our institute as well as by our licensees, such as Energy Sciences Inc. in the USA. Prices can be obtained from them.

A.

2. The capacity of the system will, of course, depend upon energy utilization in the product. The theoretical limit is 360 kg/hr/keV. at 1 Mrad dose. For a typical utilization efficiency of 60%, at the 2.5 Mrad level, the kW. ELIT-2 would handle approximately 1 metric ton per hour.

3. Because of its simplicity the ELIT accelerators should be very economical to operate but exact cost figures are dependent upon the application as with any other (radiation) sterilizer.

To A. BRYNJOLFSSON — USA, by: T. OLEJNIK — USA

Concerning plaque industrial irradiators, is the assumption of uniform density valid for all composites e.g. equal size and weight boxes have equal densities, however, if one contains water and the other air and lead it would seem that energy absorption would differ. This is an extreme case. Is there a cut off point for application of your calculations? Most products are composites of materials of different density and atomic number. Do your calculations take into account these differences and how? Do you feel these differences are sufficient for concern?

It is usually not right to assume that the product is of uniform density or of materials with uniform atomic numbers. My calculations serve merely as a guideline. The effect of non-uniformity in the atomic number is illustrated in an article: Brynjolfsson A. (1968) A significant correction factor in gamma ray dosimetry. **Advance in Chemistry Series 81** (American Chemical Society) Chapter 38 pp. 550-567.

* Holm, N. W. 1972, Process Parameter Control Dosimetry and Operation in Radiation Sterilization Processing, USP Conference on Radiation Sterilization, Washington, D.C.

General Discussion

Comments by Moderator — S. NABLO

First of all I'd like to make some general comments which relate specifically to the comments made by Dr. Holm and Dr. Sztanyik this morning. They both commented on the contribution being made by radiation processing in general and I think, I would like to elaborate on this very briefly. As I observe it, radiation processing, and I can include sterilization as one of these processes, has gone through three phases. The period of the early 50's where there was almost a wanton search for application of radioisotope waste by-products of reactors. Approximately 10 years later, we entered into a period of occasionally ill-advised application of machinery not yet ready for industrial applications and the high reliability required there. During the 60's, the decade of the 60's, there was a great emphasis for improved machinery, and we heard much about this today; so that by 1969, as Dr. Holm put it this morning, I believe we saw the beginning of the end. I really believe that the third period, in terms of industrial radiation applications, began in the 1969-70 period when much of the supporting technology had moved along, not only in the area of radiation sterilization, but in the use of industrial radiation machinery for other high speed processes — that is for curing, not only of surface coatings but of adhesives and many other areas — that are now moving along with some vitality around the world, particularly in Europe. Another factor that has been quite significant, certainly in the United States, and most of you are familiar with this, has been a Rule 66, that is the Clean Air Act, which is an effort to reduce pollution. You are all aware of this because it is a world-wide problem of decreasing fossil fuel availability. These two factors have contributed heavily to a renewed examination of this type of energy source for industrial application, largely because of the high efficiency offered by this type of energy source. A third factor, that is in addition to pollution and energy conservation, which has had a really profound effect on the acceptance in the industrial community of radiation sources, is our Occupational Safety and Health Act, and I can't emphasize enough the importance of having a document like that in the United States to refer to industrial users. It is a very concisely summarized radiation standard for the industrial environment and those factors which involve employee liability in the use or radiation on line in the factory. And, I would like to point out that it has done much to ease what I would term the paranoia, the fear of radiation as an industrial tool, particularly in the United States.

Now, we heard about equipment, accelerators, extending over a very broad range and in order to round out this understanding of where machinery is being used, I wanted to show a couple of slides.

The first one is a simple expression of where radiation can be used. I'll talk briefly about two aspects

of radiation processing. We haven't talked much about the penetration capability of the energy from electron accelerators. I wanted to point out that there is a great deal of activity in this range, discussed particularly by Dr. Ramler below 500 kilovolts. SLIDE 1. This is simply a range energy curve showing the effective penetration in this scale of microns, 1000 microns, 2000 microns, etc. as a function of energy from 200 to 1000 kilovolts. For numerous industrial applications, namely where penetration of the order of 1000 to 5000 microns are entirely adequate, namely the curing of surface coatings or alternately the sterilization of surfaces, very compact machines can be built in this range, under 500 kilovolts. Dr. Ramler discussed that this morning.

I want to show you an example of one such machine in the next slide outlining the unit that had been built for use in this area. SLIDE 2. This is an example of a very compact unit which has a penetration capability of the order of 150 microns and you can see that these machines can become very compact. This head has a diameter of 20 centimeters. In this case the single gun, whose energy is provided by a cable, provides an electron beam from a window along the length of the system. In this direction there is a similar window on the opposite side of the machine. This unit is used for sterilization of two webs which are going into a form filled sealed aseptic system. So these units can be made very compact and provide a new source, I believe, of sterilizing energy where limited penetration is required, particularly for the sterilization of packaging materials. Now the second point I wanted to make was that there has been no discussion thus far of those weights, that is the weight characteristics of the various machines that we discussed this morning. The next slide is a summary that I think might be helpful for some of you over the next few days when we are discussing damage. This simply shows configuration where these two units can be used for sterilizing webs. They are really very simple handling systems. SLIDE 3. The next slide is really what I wanted to get to, which is a lot of current density from a machine, that is of-course the electron machine, current density and amperes per square centimeter as a function of dose rate in rads per second. SLIDE 4. Now, we have been talking about many different machines today, machinery involving radioisotopes where the dose rates are in the range from 100 to 1000 rads per second, up to the region discussed by Dr. Ramler, in particular where conventional DC electron accelerators provide current density in the range of a few tenths of a milliamps per square centimeter of dose rates in the range from a million to hundred rads per second.

Dr. Brynjolfsson talked about pulse machines as did Dr. Haimson, which are capable of providing much higher current densities up into the range of a few tenths to 1 amp per centimeter square. Those machines are capable of delivering energy at rates of 10^{10} to 10^{12} rads per second, and there is a class of pulse machines which has not even been discussed here today, which extends all the way up to 10^{14} rads per second, so that, in fact, sterilizing doses can be delivered in a few nanoseconds of time. Machinery development over the last decade, particularly since 1965 now provide equipment in a reasonably reliable form, span the spectrum from 200 rads per second embraced by cobalt-60 facilities all the way up to 10^{14} rads per second for this new generation of very high intensity pulse machine. I would suggest that the future is going to be extremely exciting in a comparison of damage effects on which there is considerable literature at the present time across this great regime — 12 decades. Very rarely the physical phenomena admit to this kind of scope from 100 rads per seconds to 10^{14} rads per second. I hope we'll have more time to talk further about this, but I simply want to leave you with this kind of picture because tomorrow we'll talk about damage effects and I would suggest some understanding of what we're talking about in terms of the energy source is appropriate. With cobalt, we're always talking

of a 100 rads per second, the electrical machinery, the man-made radiation can span this very broad regime up to 10^{14} rads per second.

The meeting is now open for discussion.

Comments by

K. MORGANSTERN:

A question was posed to Dr. Ramler which I feel compelled to elaborate on. This has to do with the economics of a Dynamitron™ as an electron device. We have a truism back in R.D.I. that if you can use electrons, that is the way to go. Effectively you can give away the cobalt and will still beat cobalt on the amortization alone. Quantitizing something you said, Sam, which I think is interesting and that has to do with the radiation process industry — we're finding this industry is really explosive in nature; for example, this year we're producing at R.D.I. the equivalent of 437 kilowatts of electron beam power, it's on the floor today, in production. To equate this to cobalt equivalency, this would be equivalent to approximately 30 million curies of cobalt. The point that I'd like to really leave here is that I think the medical disposable sterilization field, like no other radiation process field, has had somewhat of a bias in direction of cobalt-60. Over the years, as many of you know, we've tried at R.D.I. to counter this a little and maybe we've gone overboard. But I think there is a place obviously for both cobalt and electrons and certainly x-rays produced from electron machines.

Comments by Moderator:

I think the whole field has suffered too much from dogmatic positions taken by one group or another and I hope we're ten years away from that. That is why, as I pointed out, what has been happening since 1969, particularly in Europe and in the United States, certainly radiochemistry developments are now moving along much more quickly in supporting real applications of radiation curing and radiation sterilization around the world.

Comment — Anonymous:

My comment really is a very simple-minded academic one, and I am a simple-minded academic. It really refers to this difference in the economics of using electrons directly rather than using them to produce bremsstrahlung. It does seem to me, of course, that if you are using them, the main problem, of course, is to deposit 2.5 megarads of dose throughout your sample, presumably it is what we are all trying to do, and it does seem to me that if one does this by direct electron radiation, one is getting a high efficiency because virtually all your electrons are stopped in most samples. If, on the other hand, you are producing bremsstrahlung as an intermediate in all this, (a) the efficiency with which you convert your electron into bremsstrahlung is not 100%; you do lose 90% and (b) you are converting a directed beam into something which is something like a 360° geometry, and therefore, you are losing a large fraction of your radiation energy. Perhaps, (c) because of the more penetrating nature of the bremsstrahlung, you are much more likely to lose a large fraction of this energy in actually penetrating many samples. So I would estimate that there might be a factor of ten gained in using the electron directly, rather than converting them to bremsstrahlung for most fairly thin or not very dense samples. This was really the point of my comment.

Comment by Moderator:

I think we will concur that the intermediate step of bremsstrahlung conversion is only interesting at very high energies, of 10 MeV or thereabouts. All industrial process applications that involve limited penetration utilize electrons directly from the system. In fact that is the first and great advantage of that small machine I showed. They will sterilize a web at 100 meters per minute with only 100 watts per centimeter energy delivered along the length of the web. One can achieve very high conversion efficiencies.

Dr. Ramler, perhaps you would like to comment on that since it was essentially addressed for your comments this morning or earlier today on bremsstrahlung.

Comment by

W. RAMLER:

We're all out to prove that the aspect we are thinking about is the electron beam versus the cobalt. In that vein, basically, I repeat, that with regard to the electron beam versus cobalt, one should go back and take a look at that from the standpoint of the efficiency. Now as far as the cure aspect, the efficiency of cure, I certainly have no doubt in my mind from the standpoint of the process technology, that the cure system with direct beam is certainly more efficient than going to the conversion aspect.

So in general, I certainly agree with what you say.

Comment — Anonymous:

I just would like to make a comment on what Dr. Brynjolfsson said about dry storage. You said it is not really suitable for sources about 50,000 curies. But of course, there are a number of plants around with more than 500,000 curies stored in dry plants and there is really very little difference. In both cases, you cool the source by means of water; in one case in the pool, in the other case by cooling coils set in the concrete of the store. So I thought I'd make that point. On the whole, there is very little difference in how you store. In general, the water storage is more easy of access if you have an experimental plant or you are worried it may get jammed up or something. You're better with the wet store. If you've got a complete well-engineered plant, you can use a dry store. Otherwise, there is not much difference.

Comment by

K. MORGANSTERN:

I do not wish to dwell on the subject too long, but I think the point made by Professor Hunt on this fact, which happens to be about correct, supports my statement when I said you can give the cobalt away if you can use electrons directly. But there is one point I neglected to mention, and it is that you obviously need a large throughput to use these machines economically. And we're talking about, for example, 60,000 megarad-lbs. per hour capability, so you need a lot of product. Second point is on X-ray conversion. I think even at 3 MeV, if you have enough power, you can afford to waste 90% of it, and still end up with a very effective source of X-rays.

Comment by

W. RAMLER:

You are certainly quite right on this and I think in the use of these accelerators, looking at the aspect of capital cost and so forth, you are really taking advantage of the structure, that accelerator structure that we now have in front of us, or will have shortly in many cases. You have to have a great deal of throughput so if you are just going to waltz around with your product for a few hours a day and have this structure in a quiet, quiescent state, your cost is certainly going to go up. It is just going to be horrendous. So you have to relate to this aspect of the throughput and tailor your structure accordingly.

Comment by

A. CHARLESBY:

We always try to persuade people that radiation does not make things radioactive and the best way of indicating this is to radiate beer and I drink it. This has turned me into a hero and it also gives me a thorough dislike for beer.

Comment by Moderator:

I would like to close this with one comment, I feel very strongly that extrapolation of technology is a dangerous thing, especially new technology; relatively new technologies such as we are discussing here. I was thinking today that material prices unquestionably will have some impact on the use of disposables and perhaps the projection, some of which we heard about today relating to the use of disposables, particularly styrene based materials, may be seriously affected by the comparative economics. We might see some direct turn-about during the next 2 or 3 years and return to cheaper materials, more readily available materials. I see this all the time in the petrochemical industry. So all I would do is raise a word of caution that in the petrochemical climate in which we find ourselves, some of the economics that are so obvious today may be changed greatly tomorrow and I am sure I do not have to tell the surgical goods manufacturers that.

I personally would like to thank Johnson & Johnson for the opportunity to participate in this meeting and I hope that our first day has set a trend for what we'll enjoy over the next few days.

SECOND SESSION

Chairmen

S. Ellis

G. Földiák

Moderator

R. J. Berry

Introduction to the Dosimetry Session – Dosimetry in the Megarad Range

S. C. Ellis

Division of Radiation Science, National Physical Laboratory, Teddington, England.

The purposes of dosimetry in the context of radiation sterilization of medical products and the definition of the quantities and units used are discussed. The principle of a hierarchical system of radiation standards is outlined which should facilitate the relation of routine dosimetric methods to primary standards and provide a clearly discernible route for international comparison

Abstract: *applicable to the field of radiation sterilization. The categories of dosemeter available, together with general properties are briefly summarized. Factors of relevance to dosimetry and dosemeter calibration in photon and electron fields are discussed and contrasted. Some aspects of the measurement of optical absorption, a preferred method of readout for a major fraction of routine and reference dosemeters in use for megarad dosimetry, are reviewed.*

The use of ionizing radiation in any process depends on the transfer of energy from the radiation beam to the material being processed. The quantitative measurement of this transferred energy is called radiation dosimetry. In many situations requirements exist for the following information: 1) the dose received at a point in the material. 2) the rate at which this dose is being accumulated. 3) the way in which the dose or dose rate varies throughout the volume of material under consideration. This session of our conference is concerned with the methods available for dosimetry and the way such measurements may be usefully applied in radiation sterilization processes. In introducing this session I thought it would be useful for me to consider such topics as — quantities — units — standardization — the roles of various categories of dosimetry systems — and general problems of calibration and measurement. Subsequent papers will consider in more detail the behaviour of specific systems, modes of application, etc.

Quantities and Units

In order to be able to communicate effectively and to compare results, it is necessary to establish satisfactory definitions of quantities and units. As in many other areas of physical measurement this aspect has been discussed at the international level, particularly by The International Commission on Radiation Units and Measurements (ICRU). The findings of this Commission in specific areas are published as ICRU Reports¹; some twenty three have been published to date. Rigorous definitions of radiation quantities and units have most recently been given in ICRU Report 19² which should form the basis of our thinking for dosimetry in the area of radiation sterilization.

The interaction of radiation with matter and the transfer of energy takes place by a variety of processes. The immediate result is normally ionization (ejection of an extranuclear electron from an atom) or excitation of an atom or molecule. Depending on the composition of the matter, the final

state, at some longer time interval, may simply reflect the additional energy imparted as an increase in temperature; or in addition energy may be stored as electric charge, chemical change or by increased crystal-lattice energy. These facts at once give clues to ways in which we can experimentally determine radiation dose. Historically the quantitative measurement of ionizing radiation got under way with methods based on the measurement of the electric charge resulting from the ionization of a gas. This led to a definition of a quantity of radiation defined in terms of the charge liberated in a specified mass of air, the well known roentgen unit. In 1950 ICRU recognized the need for concepts and qualities more generally applicable than those based on the roentgen unit and recommended that dose be expressed in terms of the quantity of energy absorbed per unit mass of irradiated material.

The quantity absorbed dose D is formally defined by:

$$D = \frac{d\bar{\epsilon}}{dm}$$

where $d\bar{\epsilon}$ is the mean energy imparted by ionizing radiation to the matter of mass dm in a volume element. The special unit of absorbed dose is the rad.

$$1 \text{ rad} = 100 \text{ erg g}^{-1} = 10^{-2} \text{ J kg}^{-1}$$

The inactivation of microorganisms requires a radiation dose of the order of 10^6 rads, creating a requirement for measurement in the range 10^5 to 10^7 rads often referred to colloquially as the megarad range.

The absorbed dose rate \dot{D} is defined as:

$$\dot{D} = \frac{dD}{dt}$$

where dD is the increment of absorbed dose in the time interval dt . No difficulties are associated with this definition for continuous radiation sources, however, for pulsed radiation problems arise. If a time interval dt is considered that spans a number of pulses, then \dot{D} will represent an average dose rate, but may have little meaning as a quantity for the comparison of radiation reactions. If alternatively a time interval which is small compared to the length of one pulse is considered, then \dot{D} can be used as a measure of the instantaneous dose rate. Since the dose rate from most pulsed sources is not constant during the pulse it may be difficult to attach a rigorous single value to this quantity. For most purposes it seems more satisfactory to specify the situation in terms of dose per pulse, pulse length and repetition frequency.

Under some circumstances it may be necessary to note that $\bar{\epsilon}$, the *mean energy imparted*, is the expectation value of the stochastic quantity *energy imparted* ϵ . This latter quantity being subject to statistical fluctuations which may be significant if the volume of interest is very small or the fluence of particles very low. For such limiting conditions the absorbed dose at a point can only be described by the mean or expectation value.

Absorbed dose is relevant to a particular material irradiated for a specified period in a given radiation field. A radiation field may be specified by the dose rate at a point, in which case the medium must be defined. Water is normally taken as the reference material for this purpose.

A system of standards

In putting these concepts into effect it is necessary to consider how we can ensure that all practical measurements are comparable and approach as closely as possible to the true value, i.e. that everyone's rad is as nearly equal as possible and an accurate measure in terms of the defined unit. In line with procedures that have evolved for other quantities a hierarchical system of standards seems most practical. The principle of such a system is indicated in Figure 1. The primary standard functions as a point of reference and typically would be the national standard maintained in a standardizing laboratory or similar institute. Specific dosimetry systems are calibrated by comparison with the primary standard to determine response in terms of absorbed dose for particular radiation qualities and conditions. An intermediate stage, which we can call the reference or secondary standard, may be used to connect the primary and routine working dosimetry system. The dosimeter chosen for this intermediate role should ideally be readily transportable e.g. by mail, and should retain the maximum accuracy, precision and freedom from quality and dose rate dependence.

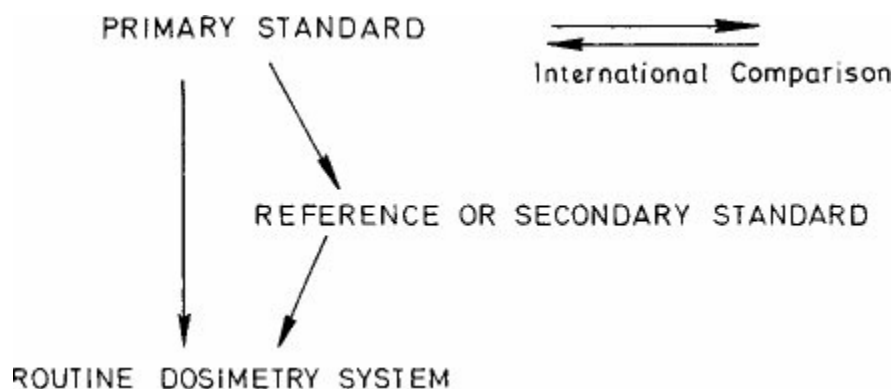

Figure 1. A system for the interrelation of standards and dosimeters.

We should look forward to the situation where primary standards at the megarad level are maintained at a number of points around the world. These standards can be subjected to comparison and the resulting network of dosimetry systems should ensure that our objective of reliable dose measurement will be fulfilled. Comparison of independently established primary standards is a major means of detecting systematic errors which of course may be present even though high precision or repeatability is observed.

A hierarchical system of the type outlined above is in established use for radiotherapy and protection level dosimeter calibration³. The organization for the formal comparison of primary standards is available through the Bureau International des Poids et Mesures (BIPM), who are responsible for the comparison of national X-ray and radioactivity standards⁴. To date no such comparisons in the megarad range have been conducted, it remains for us to decide when we are ready to call the machinery into action.

The functions of various categories of dosimeter

Ideally a primary standard will be achieved by using an 'absolute' instrument. This is normally defined as an instrument which can be constructed and used to measure radiation in terms of the defined unit without the necessity of calibration for response in a known radiation field. For the measurement of absorbed dose a calorimeter is the absolute instrument. An absorbing medium is

chosen in which the total radiation energy imparted is converted into thermal energy. Thus by measuring the temperature rise and using an independent electrical heating calibration of the absorber, the dose may be directly expressed in J kg^{-1} . Radak and Markovic have given a useful discussion of the principles and types of experimental approach suitable for use in the megarad dose range⁵.

Some difference of opinion exists as to whether a chemical dosimeter such as the Fricke (ferrous sulphate) system should be described as absolute. The behaviour of this particular dosimeter is well understood, for many radiation conditions it is possible to measure absorbed dose without having available a known field of radiation. However the factors used to convert the observed chemical change into energy units cannot be derived from first principles. In practice these factors have been obtained by experimental comparison with, for example, a calorimeter and for the Fricke system measurements covering a wide range of radiation qualities and conditions are available. It seems therefore that whilst the Fricke dosimeter should not be classified as absolute it may usefully serve as a primary standard in many types of radiation field.

In addition to the absolute dosimeter we have a very large number of dosimeters which depend on a permanent chemical or physical change induced in a material by a dose of radiation. To function quantitatively this category requires calibration of the dose-response relationship. These integrating passive dosimeters are of great utility in radiation processing, they can so easily be introduced together with the product into a radiation plant and the integrated dose measured at a later date. What are the characteristics that make a reaction suitable for use as a dosimeter? Some criteria are listed in Table I, the relative importance for various purposes being indicated by double shading for strongly required properties, single shading less important and an open box unimportant. A reference dosimeter being used as a transfer system between the primary standard and a routine plant dosimeter should approach ideal behaviour. For example, it should be possible to calibrate a routine dosimeter at a radiation facility where the dose-rate, energy spectrum and temperature is varying and obtain a true dose calibration without detailed knowledge of these factors. The requirements for a routine dosimeter in use at a specific plant may be relaxed somewhat, but low cost and simplicity in use will have a high priority in this case. Finally some types of dosimeter are more suitable for the assessment of spatial distribution and interfacial dose. This category is required for plant commissioning and for determining irradiation conditions with a new product. In this case it is necessary to select a system which will provide a large area two dimensional scan to be made in readout or to have a thin film which can be used at interfaces. Compromises may have to be accepted with respect to other properties to achieve this. Subsequent papers in this session will discuss the detailed behaviour of the presently available dosimeters. I think we shall see that continued effort is needed, if we are to develop the ideal dosimeters.

Table I. — Dosimeter Performance Related to Type of Application

Property	Reference standard	Routine dosimeter	Plant investigation
Intrinsic reproducibility	Diagonal lines (top-left to bottom-right)	Diagonal lines (top-left to bottom-right)	
Pre-irradiation stability	Diagonal lines (top-left to bottom-right)	Diagonal lines (top-left to bottom-right)	
Post-irradiation stability	Diagonal lines (top-left to bottom-right)	Stippled pattern	
Environment insensitivity	Diagonal lines (top-left to bottom-right)	Stippled pattern	Stippled pattern
Linear response	Stippled pattern		Stippled pattern
Wide dose range	Stippled pattern		
Dose-rate independent	Diagonal lines (top-left to bottom-right)	Stippled pattern	Stippled pattern
Quality independent	Diagonal lines (top-left to bottom-right)	Stippled pattern	Stippled pattern
Rapid readout		Diagonal lines (top-left to bottom-right)	
Low cost		Diagonal lines (top-left to bottom-right)	
Distribution capability			Diagonal lines (top-left to bottom-right)
Thin film			Diagonal lines (top-left to bottom-right)

Factors arising from the nature of the radiation field

A number of factors concerning the nature of the radiation field and the interaction with the dosimetric medium must be taken into account for proper dose measurement and calibration. The two most commonly encountered cases — cobalt-60 irradiators and high energy electron beams — exhibit a number of differences which will be briefly considered in the next two sections.

Cobalt-60

The source configuration of a cobalt-60 irradiator can be kept constant and therefore the dose-rate at any point in the field can be reproduced and varies only with the decay of the radioactive source. Relatively infrequent checks with the primary standard are needed for a well designed calibration irradiator which will also feature a small dose-rate variation over the volume occupied by the dosimeters. Two factors which must be taken into account are the establishment of electronic equilibrium (buildup) and the degradation of the primary photon spectrum by scattering. For a typical process irradiator scattering by source containers, product, conveyor and shielding, results in an energy distribution which taken in conjunction with irradiation from both sides, means that little buildup will normally occur. It is not therefore necessary to use a scatter free source for dosimeter calibration, but it is desirable to surround the dosimeters with a few millimeters thickness of low atomic number material to ensure electronic equilibrium. The arrangement in use at the National Physical Laboratory is shown

in Figure 2. A polystyrene jig provides positioning and buildup, the cavity can be packed tightly with doseimeters or fitted with adaptors to receive standardizing chemical doseimeters.

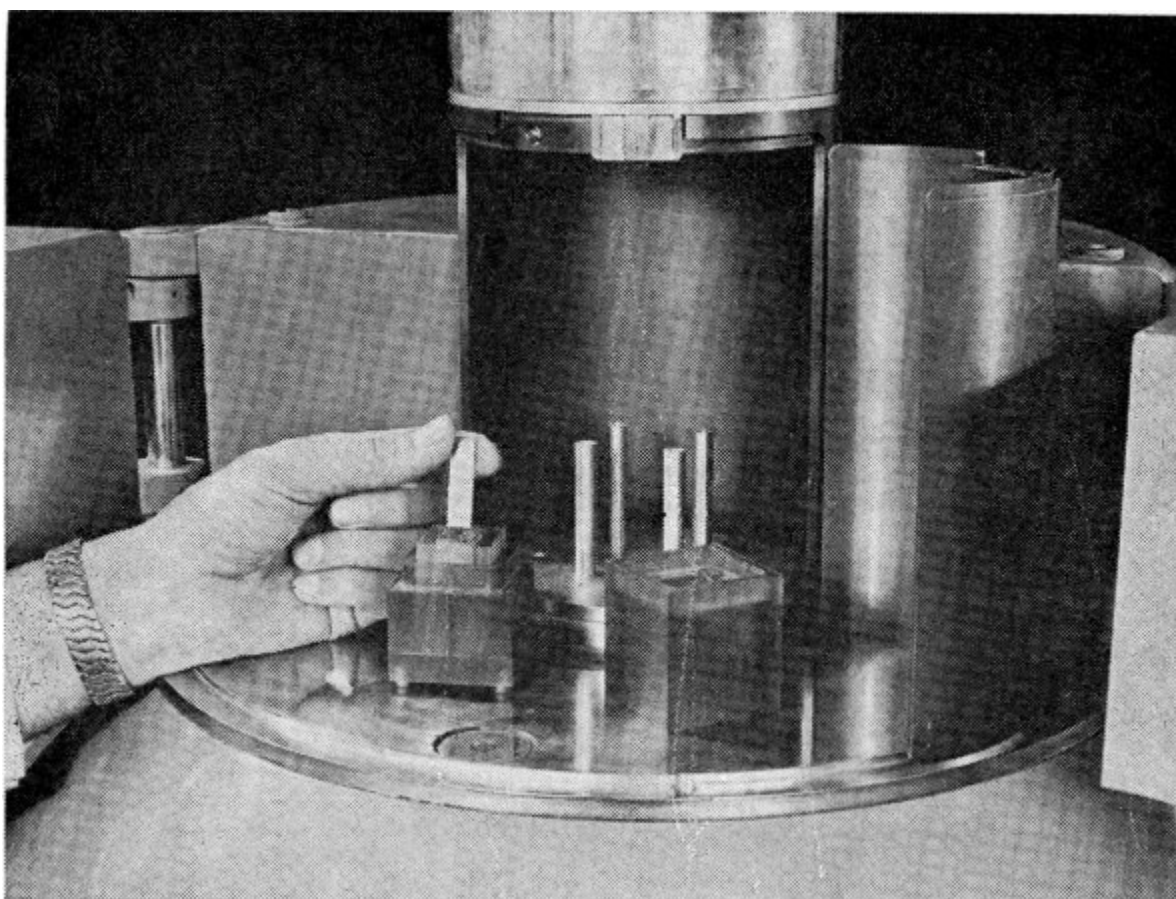

Figure 2. Irradiation jig, providing precise positioning and buildup for calibration for doseimeters in a cobalt 60 irradiator.

The energy deposited in material by photons, under equilibrium conditions, is expressed by the mass energy absorption coefficient. Thus the relation between the dose in two materials, 1 and 2, exposed in the same photon fluence is given by:

$$\frac{D_1}{D_2} = \frac{(\mu_{en/\rho})_1}{(\mu_{en/\rho})_2}$$

where $\mu_{en/\rho}$ is the coefficient applying to the material at a particular photon energy. In practical situations we have a distribution of photon energies as explained above. It is therefore necessary to calculate the mean absorption coefficient corresponding to the time averaged mean energy spectrum to which the doseimeter has been exposed. Methods appropriate to our present area of interest have been given by Brynjolfsson⁶. A practical solution is to match the dosimetry medium to the material in which we require to measure dose, that is, make the ratio of absorption throughout the energy range likely to be encountered, near to one. Table II gives values for the ratio, absorption coefficient of water to that of a number of media of interest in dosimetry, values greater than one correspond to greater energy deposition in the specified medium. Many aqueous chemical doseimeters show only small deviations provided that solute concentrations are low ($\sim 0.01M$) or comprise low atomic number atoms. The Fricke doseimeter, effectively $0.4 M H_2SO_4$, and the oxalic acid doseimeter are in this category, whereas the more concentrated versions of ceric sulphate are not. The organic polymers are of interest either as dosimetry materials of irradiated products, polyvinyl chloride of those listed shows the greatest energy

dependence due to the high weight fraction of chlorine present.

Table II. — Ratio of mass energy absorption coefficients, water to various materials

Photon energy MeV	$\frac{[\mu_{en}/\rho]_{H_2O}}{[\mu_{en}/\rho]_M}$					
	0.4 M F ₂ SO ₄	Perspex™	Polystyrene	Polythene	FVC	Iron
2.0	1.00	1.03	1.03	0.97	1.07	1.18
1.0	1.00	1.03	1.03	0.97	1.07	1.18
0.5	1.00	1.03	1.03	0.97	1.07	1.12
0.1	0.99	1.08	1.11	1.05	0.56	0.12
0.05	0.91	1.39	1.77	1.76	0.16	0.03

High energy electrons

A number of differences must be taken into account when measurements and calibrations are to be made in an electron field. Firstly the absorption of energy from an electron beam proceeds much more rapidly per unit thickness of matter than for photons of similar energy. For example the maximum range of a broad beam of 10 MeV electrons in water is about 50 mm and the maximum depth over which the dose varies by less than $\pm 5\%$ is about 12 mm. The problem of ensuring that on these grounds equal dose is delivered to two dosimeters is therefore much greater than for photons.

The dose ratio in two different materials irradiated in the same electron fluence is given by:

$$\frac{D_1}{D_2} = \frac{[s/p]_{col 1}}{[s/p]_{col 2}}$$

where $[s/p]_{col}$ is the collision mass stopping power of the material for the electron energy of interest. A monoenergetic electron beam is converted into a continuous energy distribution or slowing down spectrum during passage through matter, therefore the average mass stopping power for the electron spectrum, at the point of interest, should be used. Refined procedures for such calculations have been reviewed by Burlin⁷. A simple approximation may be made by using stopping powers corresponding to a mean effective energy \bar{E} derived as follows:

$$\bar{E} = E_0 (1 - z/R_p) \quad \text{for } z < 0.9 R_p$$

where z is the depth and R_p is the electron range expressed in the same units. For low atomic number absorbers experimental and calculated values derived by this method have been found not to deviate by more than 2%⁸. The values of the mass stopping power ratios for water to several substances are given in Table III. For the organic polymers the value is near to one and changes rather slowly with energy in the range likely to be of interest. Uncertainties due to this cause seem less likely than for photon beams.

The fact that the output of an electron accelerator can be varied is however an important distinction from cobalt-60 irradiators. Some means must be provided to monitor accurately this output particularly for precise dosimeter comparison or calibration. Gas filled ion chambers intercepting the

beam are only satisfactory with low beam currents, inappropriate to the high dose range, because of recombination effects. Secondary emission chambers, in which electrons ejected from the walls are collected in a vacuum, operate at much higher dose rates⁹. With pulsed accelerators a non-intercepting induction monitor may be used consisting of a toroidal pickup coil wound on a magnet. Such a method is not limited by beam current¹⁰. Proportionality between dose and monitor reading, for the devices mentioned above, is only maintained at constant energy. For precise dosimeter calibration independent monitoring of beam energy or frequent substitution of the primary dosimeter is necessary to establish constancy of operation. An alternative approach is to utilize a primary standard that can be simultaneously irradiated with the secondary dosimeter. The polystyrene petri dish water calorimeter¹¹ has been used for the calibration of film dosimeters, by sandwiching the latter between the petri dish and the styrofoam insulation. Bewley¹² has described a carbon disc calorimeter which contains a plastic dosimeter in a cavity in the thermally active carbon disc. Both these arrangements minimize the errors that could arise due to machine output, but present problems in accurately estimating the relative fraction of dose absorbed in the calorimetric medium and the secondary dosimeter.

Table III. — Ratio of collision mass stopping powers of water to various materials

Electron energy MeV	$\frac{[s/\rho]}{[s/\rho]_M}$ H ₂ O			
	Perspex™	Polystyrene	Polythene	Iron
10	1.04	1.04	0.97	1.33
8	1.04	1.04	0.97	1.34
2	1.04	1.04	0.97	1.38
1	1.04	1.04	0.97	1.40
0.5	1.04	1.03	0.96	1.42
0.1	1.03	1.03	0.95	1.48

The problem of dose rate effects

Many modern accelerators are capable of producing very high electron dose rates, and it is thus possible to operate in the range in which many reactions exhibit a variation of yield with dose rate. Account must be taken of this possibility both with respect to the effect on dosimetry and also on the efficiency and side effects of the radiation treatment being controlled. An additional dimension is added to the problem because many electron sources are pulsed and significant variation of pulse width and mark space ratio may be encountered. For example a 0.1 μ s pulse delivering one megarad could result in a radical concentration as high as 0.01 M, leading to a greatly enhanced proportion of radical — radical reactions. Hence a deviation in yield commences for many well known aqueous chemical dosimeters when the dose per pulse exceeds about 10^3 rads. Local oxygen depletion for which replenishment is diffusion controlled and therefore comparatively slow, is another mechanism influencing reactions under pulse conditions, of importance in solid phase dosimeters and of course microorganisms. Subsequent contributions to this session will discuss dose rate effects for specific dosimeters and materials, as well as methods for monitoring at high dose rates. However because of the difficulties it seems relevant to discuss at this point the need for absolute dosimetry and the usefulness of

'dose' under the conditions prevailing at extreme dose rates. Holm¹³ has drawn attention to this problem and has suggested that an alternative is to rely on "effects dosimetry", in which one measures not the dose in rads but the extent to which the property of interest in the irradiated material is changed. For example, if we were concerned with altering a mechanical property such as extensibility of a plastic film, direct measurement of this property on the product would be the processing criterion. This is obviously a practical solution in cases where a simple physical or chemical test can be employed. However in the case of sterilization it is generally agreed that satisfactory sterility testing on the product is difficult and obviously cannot provide a measure of overdose. Effects dosimetry directly on the product, as regards sterility, is therefore not practical.

The principle can be applied by using a dosimeter comprising a biological test piece, which is assayed by determining the fraction of organisms surviving. It is necessary to ensure that the species of organism and its environment satisfactorily simulate the product situation, and in particular the behaviour at extreme dose rates. Control of radiation damage in base plastic materials of the product is also necessary and one might argue the case for an additional monitor based on material effects. Considering the cost and time delay introduced by reliance on a routine microbiological effects dosimeter the following procedure would seem more practical for use with extreme dose rate conditions: Microbiological action and materials effects are related to the response of some convenient physical or chemical dosimeter, for the specific irradiation conditions in use. In my opinion it is highly desirable that this dosimeter be also calibrated, under the working conditions, against a standard that is not dose rate dependent i.e. a calorimeter. In addition, the fullest specification of other beam parameters should be attempted. It is worthwhile to strive for the expression of biological and material effects in terms of precise physical specification of the radiation dose. Unless this is done we shall make little progress in the fundamental understanding of the processes that we are utilizing.

Spectrophotometric measurements in dosimetry

Spectrophotometry is a frequently used analytical readout method for dosimetry and it is therefore pertinent to examine instrumental factors which may influence the accuracy and precision of dose measurement. In the case of liquid chemical systems, dosimetry is often based on established literature values of the yield (G) and extinction coefficient (ϵ) of the product. An example which has been studied from this point of view is the Fricke dosimeter where $[\text{Fe}^{3+}]$ is measured at 304 nm. Broskiewicz¹⁴ has examined 83 values for $\epsilon(\text{Fe}^{3+})$ reported in the literature and found a range of $\pm 3\%$ about the mean. In a collaborative test of spectrophotometers at 72 laboratories¹⁶ the optical density of a potassium dichromate solution showed a coefficient of variation of 2.5%. It must be concluded that the possibility for significant differences in optical density scales exist, though Broskiewicz also concludes that the preparation of a solution containing an accurately known ferric ion concentration requires great care.

Clearly minimum uncertainty will arise when an absolute determination of G and subsequent dosimetry is performed using the same spectrophotometer. Where this is not possible, for accurate work, a careful measurement of the extinction coefficient should be made or the optical density scale of the instrument checked by a reference standard solution or calibrated glass filter.

In the case of solid phase dosimeters such as organic polymers or polymer dye systems dosimetry may be performed by the use of an optical density-dose response curve, provided by a calibrating organization for a specific batch of material. The need to minimize performance differences between

the spectrophotometers is again obvious. In addition to the absolute value and linearity of the optical density scale, accuracy of wavelength setting and spectral bandwidth are important. Measurement is often not at an absorption peak and therefore the change in optical density with wavelength can be significant, e.g. about 2% per nm for Perspex™ HX and Red 4034. The effects of varying reflection losses and deflection of the light beam for samples which are optically inferior to say an optical cell for solutions, must be guarded against. The significance for dosimetry of the above mentioned factors and of stray light has been summarized by Ellis¹⁶. Assessment of the uncertainty introduced by spectrophotometry has been attempted by collaborative tests on Perspex™ HX. In one test initiated by the 'U.K. Panel for Gamma and Electron Irradiation', one set of irradiated dosimeters was circulated to seven dosimetry laboratories, a coefficient of variation in Δ OD of 3% was observed¹⁷. In another comparative test Chadwick has demonstrated that three spectrophotometers showed good agreement and that a fourth gave readings differing by up to 10%¹⁸. Additional checks on the spectrophotometers used led him to conclude that a faulty wavelength setting was the cause of this discrepancy. The use of a set of dosimeters, irradiated to known dose levels by a calibrating laboratory, to check the calibration curve is perhaps the simplest method for ensuring that uncertainty due to spectrophotometry is minimized.

Another effect must be noted when thin film dosimeters are in use, due to interference resulting from multiple reflections at the air/plastic interface. This results in a periodic modulation of the absorption spectrum with wavelength, due to a twice reflected ray being either in or out of phase with the direct ray as the wavelength changes. The phenomenon has been studied by Bishop & Benson¹⁹ using poly (halo) styrene dosimetry films of thickness 6-25 μ m. The effect is greatest the smaller the film thickness and the more the film approaches optical perfection, an uncertainty in Δ OD as large as 20% being observed. The recommended method for extracting the true optical density is to derive the centre line of the spectrum envelope; however, perhaps the most important point is to be aware of the phenomenon and check for presence when thin films are being used.

Conclusion

I have attempted to show how routine systems of dosimetry can be connected to primary standards, thus ensuring greater uniformity of radiation dose measurement in sterilization processes. The various categories of dosimeter available have separate roles to play, the particular system chosen being dependent on the characteristics of the radiation field in use. In the following papers of this session the properties of a number of dosimetry systems will be discussed in more detail and at the end of this session we shall be able to make some assessment of relative merits in various applications.

References

1. ICRU. Publications, P.O. Box 30165, Washington D.C. 20014, U.S.A.
2. ICRU (1971) *Radiation Quantities and Units*. ICRU Report 19 Washington.
3. Jennings, W. A. (1970). Standards and their dissemination in the field of radiological measurements. In *Radiation Dose and Dose Distribution Measurements in the Megarad Range*. Proc. Symp. U.K. Panel on Gamma and Electron Irradiation at NPL. July 1970, pp 2-3.
4. Allisy, A. (1973). Some comparisons organized by the International Bureau of Weights and Measures. In *National and International Radiation Dose Intercomparisons*, IAEA, Vienna, pp 1-5.
5. Radak, B. and Markovic, V. (1970). Calorimetry. In *Manual on Radiation Dosimetry*, ed. Holm, N.W. and Berry, R.J., Marcel

Dekker Inc., New York, pp 45-81.

6. Brynjolfsson, A. (1968). A significant correction factor in gamma ray dosimetry. In *Advances in Chemistry Series No. 81*, A.C.S. Washington pp 550-567.
7. Burlin, T. E. (1968). Cavity-chamber theory. In *Radiation Dosimetry* ed. Attix, F.H. and Roesch, W.C. Academic Press, New York, Vol. 1, pp 331-392.
8. ICRU 1972 Radiation Dosimetry: Electrons with initial energies between 1 and 50 MeV. ICRU Report **21**, p. 20.
9. Taimuty, S. I. and Deaver, B.S. (1961). Transmission current monitor for high energy electron beams. *Rev. Sci. Instr.* **32**, 1098-1100.
10. Gardiner, S. N., Matthews, J. L. and Owens, R. O. (1970). An accurate non-intercepting beam current integrator for pulsed accelerator beams. *Nucl. Instr. Method*, **87**, 285-290.
11. Brynjolfsson, A., Holm, N. W., Tharup, G. and Sehested, K. (1963). Industrial sterilization at the electron linear accelerator facility at Riso. In *Proc. Industrial Uses of Large Radiation Sources*, IAEA, Vienna **2** p. 281.
12. Bewley, D. K. (1969). A simple calorimeter for the calibration of solid state dosimeters. *Ann. N.Y. Acad. Sci.* **161**, 94-98.
13. Holm, N. W. (1973). On the relevance of absorbed dose standardization and international dose comparison with respect to the use of pulsed electron accelerators. In *National and International Radiation Dose Intercomparisons*, IAEA, Vienna pp. 67-77.
14. Broskiewicz, R. K. and Bulhak, Z. (1970). Errors in ferrous sulphate dosimetry. *Phys. Med. Biol.* **15**, 549-556.
15. Gridgeman, N. T. (1951). The accuracy and precision of photoelectric spectrophotometry. *Photoelectric Spectrometry Group Bulletin*, **4**, 67-79.
16. Ellis, S. C. (1970). Problems in spectrophotometry and their influence in radiation measurements. In *Radiation Dose and Dose Rate Measurements in the Megarad Range*. Proc. Symp. U.K. Panel on Gamma and Electron Irradiation at NPL. July 1970, pp. 18-23.
17. Crookall, J. O. and Marshall, C. H. (1970). The effect of spectrophotometry error on the accuracy of the Perspex HX megarad dosemeter. *Phys. Med. Biol.* **15**, 319-324.
18. Chadwick, K. H., ten Broeke, W. R. R. and Rintjema, D. (1973). An intercomparison of readout systems for the clear Perspex dosimeter. In *National and International Radiation Dose Intercomparisons*, IAEA, Vienna, pp. 33-40.
19. Bishop, W. P. and Benson, J. L. (1972). Operational treatment of multiple reflection interference in the readout of thin-film poly (halo) styrene dosimeters. Sandia Laboratories, New Mexico, USA. Report SC-DR-72 0641.

Solid-Phase Chemical Dosimeters

W. L. McLaughlin

*Center for Radiation Research, National Bureau of Standards, Washington, D.C. 20234, U.S.A.**

and

Atomic Energy Commission, Research Establishment Risø, DK-4000 Roskilde, Denmark.

Commercial products are identified in this paper for the sake of clarity. Such identification is not meant to suggest endorsement by the National Bureau of Standards or the Danish Atomic Energy Commission.

* Mailing address.

Abstract: *The radiation chemistry and response characteristics of some solid-phase chemical dosimeters (plastics, dyed plastics, and glasses) are reviewed. The analysis used for dosimetry is mainly spectrophotometry in the ultraviolet and visible spectrum. Systems having a reproducible response and a stable optical absorbance are selected from as many as 28 candidate systems, some of those showing promise for radiation sterilization applications being: polymethyl methacrylate, dyed polymethyl methacrylate, polycarbonate, tetrazolium salt in polyvinyl alcohol, dyed polychlorostyrene, and dyed polyamide. Major sources of dosimetric error, such as temperature and dose rate dependence, instability, non-uniformities, and batch differences, are examined.*

Introduction

A bewildering assortment of solid materials serves as radiation sensors for determining large quantities of ionizing radiation used in commercial sterilization (i.e., absorbed doses greater than 10^6 rads). They may be crystals, glasses, photographic emulsions, plastics, dyed films, etc. Usually the radiation effects that are measured for dosimetry are changes in the optical properties, such as variations in the luminescence or absorption spectra. The systems discussed here are primarily those undergoing a measurable change in optical transmission density ("absorbance") at a given wavelength in the ultraviolet or visible part of the spectrum.

Many traditional solid-state dosimeter systems have been used for determining smaller absorbed dose ($< 10^5$ rads): inorganic crystalline materials that experience measurable photo- or thermoluminescence effects after irradiation^{5,7,19,30}; photographic emulsions whose radiation-induced latent-image silver nuclei are developed chemically to a grey-scale metallic silver grain image, the degree of darkening being measured photometrically^{6,7,68}. Other solid-state systems are capable of dosimetry in the megarad dose range: organic phosphors (e.g., anthracene, biphenyl, stilbene) that undergo changes in photostimulated luminescence or experience absorption spectrum changes upon irradiation^{7,30,40,91,97}; saccharides (glucose, xylose, and trehalose) showing lyoluminescence³;

semiconductors (e.g. solar cells) that suffer degradation of photocurrent intensity due to irradiation^{7,72,76}; glasses containing traces of activating metals (e.g. cobalt, silver, manganese) which cause darkening due to color center formation when irradiated^{7,30,68,97}.

There are also other types of solid chemical dosimeter systems, such as plastic films and dyed plastics, many having a radiation response suitable for radiation sterilization dosimetry. Besides measuring absorption spectra changes in the ultraviolet due to irradiation of plastic films, one can also measure the altered infrared spectra of some plastics, such as polyethylene and polymethylmethacrylate^{61,63,95}. Other radiation effects in plastics that can be used for dosimetry are: changes in photoluminescence⁸³; decrease in solubility³⁶; decrease⁴ or increase³⁶ in mass; decrease in elongation and tensile strength⁹⁵; changes in electron spin resonance spectra⁶⁰; electrical conductivity changes⁹⁰; melting point changes⁶⁶. Dyed plastics containing either dyes that darken or bleach under irradiation may also serve as dosimeters using changes in the optical absorption in the visible part of the spectrum^{7,53,68,69}.

The aim of this paper is to review the radiation chemistry and response characteristics of some of the better known solid-phase chemical dosimeters (plastics, dyed plastics, and glasses), especially those analyzed by spectrophotometric means. Emphasis is given to those systems having the most promise for radiation sterilization dosimetry, that is, a reproducible response at megarad absorbed doses. Major sources of dosimetric error, such as temperature and dose rate dependence, instability, non-uniformities, and batch differences, are examined. With a properly calibrated solid dosimeter, particularly a thin-film system, it is possible to measure accurately dose distributions in irradiated packages^{55,71}.

Radiation chemistry and causes of dosimetric error

The radiation chemistry of polymeric systems is treated in some detail elsewhere in these proceedings. There are also comprehensive sources of information on the chemical behavior of irradiated plastics^{23,25,27}, solid solutions containing dyes^{53,68} and glasses^{7,31}. Practical articles related to dosimetry with these systems may also be found in the literature^{22,45,46,47,94}. For these reasons, only a cursory glance will be given here to the radiation chemistry of the classes of solid chemical systems covered.

At the megarad absorbed dose levels of interest in radiation sterilization, predominant effects are the crosslinking of polymeric chains, the bleaching of dyes, and the darkening of glasses and crystals. In most systems, the extent of these changes varies with dose rate, temperature, and concentrations of atmospheric oxygen and other ingredients present as additives (e.g., plasticizers, solvents, anti-oxidants, monomers, aromatic stabilizers, ultraviolet shields). Degradation of plastics due to link scission occurs in competition with crosslinking aided sometimes by the presence of radiation-produced free radicals and ionic species. Color-center production by irradiation of solid-state systems at low temperatures is also less efficient due to the formation of greater concentration of unstable trapped luminescence centers. Oxygen and moisture diffusion from the environment may contribute to instabilities of color centers arising from chemical, photolytic, or thermal bleaching of radiation-colored systems.

Crosslinking and dye formation by radiation energy deposition results in absorption bands in the ultraviolet and visible parts of the spectrum, particularly because of the greater concentration of double-bonded molecular groups. The more stable color used for dosimetry is due to chromophores such as

=C=O, as in the case of irradiated polymethyl methacrylate and polycarbonate, and =C=N- or -N=N-, as in the case of dyed plastics. These are more apt to be double-bonded side chains paired with trapped free radicals than conjugated unsaturation in the main polymer chain (i.e., dienes or polyenes).

Radiation-initiated chain reactions in organic materials resulting in inordinately high G-values (>10) are generally not appropriate for dosimetry, because they are not easily controlled or predictable. G-values for the production of stable trapped free radicals ($\cdot\text{H}$, $\cdot\text{CH}_2$, $\cdot\text{HCO}$, etc) are orders of magnitude smaller (<1). The efficiency of the production of color centers in solid-state systems is generally high and depends on the presence of impurities, where crystal dislocations and light-absorbing and scattering centers are gathered. Only if the traps are sufficiently deep and if attacking free radicals and ions are effectively scavenged is the radiation-induced absorption spectrum stable enough to serve for dosimetry. Spontaneous annealing or bleaching of the color centers or delayed reactions to subsequent coloration during storage at normal temperatures may be eliminated somewhat by post-irradiation "development," as by using a heat treatment. In the case of some plastics and glasses, it is the color centers most apt to bleach upon prolonged storage at room temperature that are annealed by the treatment, leaving the more stable part of the absorption for photometric analysis.

Changes in optical absorption in the ultraviolet or visible spectrum due to irradiation may consist of a broad spectral band or series of bands. Some parts of the absorption spectra are more stable than others. For example, the induced absorption band in polycarbonate centered at 340 nm wavelength is relatively stable, whereas one at 400 nm fades rapidly due to oxygen diffusion⁸⁴. The shorter wavelength portions of broad absorption bands in polymethyl methacrylate (PMMA) and polyvinyl chloride (PVC) increase in amplitude and the longer wavelength parts decrease. At about 315 nm in PMMA²¹ and at about 395 nm in PVC⁵⁸, after post-irradiation heat treatments (in the case of PVC), the optical change is relatively permanent.

In irradiating some halogenated hydrocarbons, such as PVC or chloral hydrate, there is first free-radical production with two main secondary effects: HCl acid formation and coloration. HCl formation is temperature-, O_2 -, and rate-dependent, the radiation response being less in air than in vacuum and less at low temperature and high dose rates. The presence of O_2 desensitizes radiolytic darkening by competing with dehydrochlorination, which itself is the main cause of coloration in the form of double-bond formation, dye indication or dye sensitization. Although the production of HCl in chlorinated hydrocarbons is linear with dose³⁸, acid-forming reaction may result in subsequent chain reactions, causing variations of response with dose rate. Recombination of radicals, ions, and various coloring species also contribute to non-linearities and rate dependence of response^{23,88}, as well as saturation of color formation. HCl itself is sufficiently volatile to evaporate after irradiation, causing instabilities of the color formed by the presence of an indicator.

Absorption in the blue and ultraviolet part of the spectrum upon irradiation of PVC is due partly to formation of polyene groups upon the loss of HCl. The polyene absorption consists of discrete bands superimposed on a broad absorption band in the ultraviolet, the longer the polyene sequence length, the longer the wavelength of the band. The wavelengths of these superimposed bands are stable after irradiation, but their amplitudes are not. The resulting post-irradiation color changes are O_2 -sensitive. If irradiated PVC is stored in a vacuum, absorption bands grow rapidly, but the presence of O_2 suppresses this effect. There also occurs polyenyl free-radical formation, which is diminished under oxygenation or varies with the presence of additives in the polymer. Allyl, dienyl, or trienyl radical

concentration is also less in the presence of O₂. Absorption bands due to these groups occur at shorter wavelengths (~ 250, 290, and 330 nm) than does polyene chain absorption, which reaches up to ~ 500 nm. The shorter wavelength free-radical bands are more sensitive to O₂ and thus are less stable than are longer wavelength bands.

Another source of dosimetric error is the variation of G-value of the formation of the coloring species with changes in spectral energy or radiation type (as in the case of PVC or other higher atomic-number materials, such as glasses), unless appropriate corrections for cavity theory are made^{18,69}. Only by making such corrections can the absorbed dose be expressed in terms of energy deposition in a material of interest, when the dosimeter material itself may be surrounded by some other material during irradiation or during calibration.

Unless film dosimeters are carefully monitored, a cause for poor reproducibility of response is variation in the thickness of a sensor or in the lateral distribution of dye or other sensitizers in the film. Other potential problems in making a correct interpretation of dose by optical analysis are the effects of light, moisture, and other environmental factors. One of the largest sources of error is the variation of response with differences in production batches or in lots supplied by different manufacturers. Another potential cause for erratic dosimetry arises from imprecision in the spectrophotometric analysis of optical absorption changes due to irradiation.

Systematic errors can be minimized by calibrating properly the dosimeter response with the type of radiation to be used in practical situations. Spectrophotometric readings of absorbance can be calibrated at a given optical wavelength, taking appropriate precautions to eliminate sources of error²⁸. It is important also to prevent scratches, dust, and fingerprints from occurring, and to correct for changes that may occur in response curve shapes, instabilities, temperature dependence, etc.

Dosimetric response relative to sterilization by irradiation

An advantage in using most plastic and dye dosimeters for dosimetry in radiation sterilization is that they are of low atomic-number ingredients similar to biological systems. Absorbed doses in plastics or dyed plastics due to irradiations with cobalt-60 gamma rays (1.25 MeV photons) or 1 to 10 MeV electron beams are similar, in most cases, to those in a biological medium. A problem may arise, however, when the radiation spectrum is broadened, due to secondary electron production during penetration through thick absorbers or due to the presence of higher atomic-number scattering materials. It is known, for example, that spectra of essentially perpendicularly-incident monoenergetic gamma rays and electrons are degraded more and more with depth of penetration, as indicated in Figures 1 and 2.

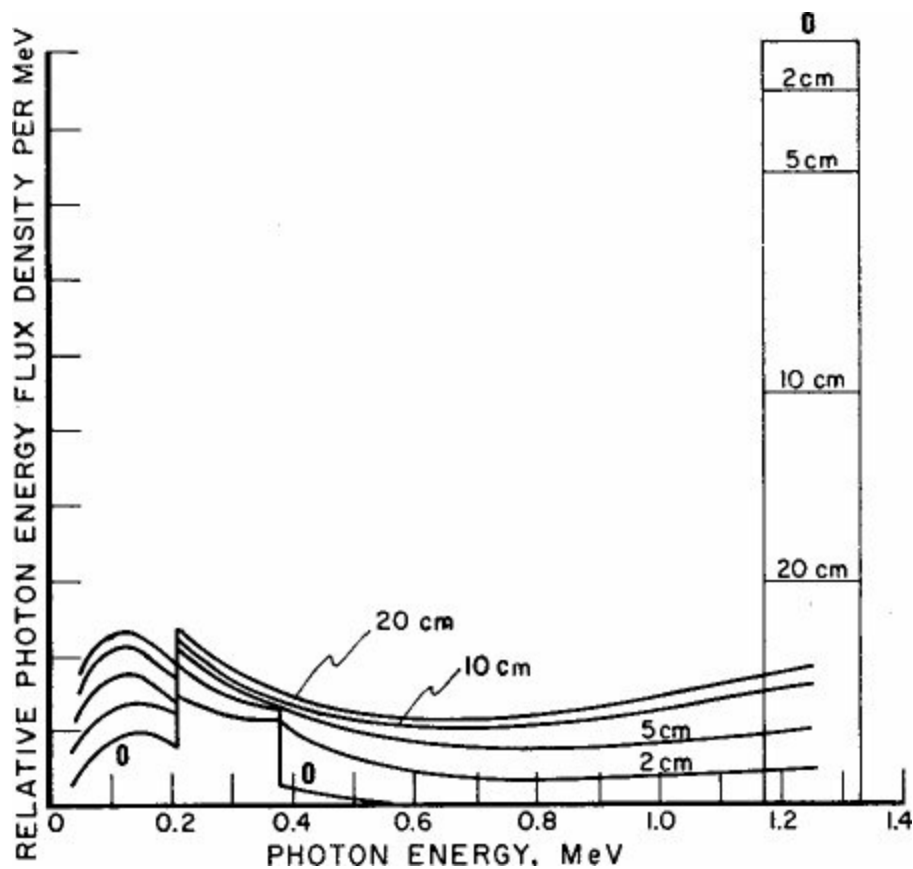

Figure 1. For an infinite cobalt-60 gamma ray plaque source, calculated photon spectra (relative to maximum value of the average primary photon energy flux density at the front surface of a planar semi-infinite water absorber) at various depths in the irradiated water, including single and multiple scattering, in terms of the photon energy flux density, ψ (in units of MeV photons/cm² per keV interval), as a function of photon energy (MeV). The areas under the vertical bars on the right represent the relative values of energy flux density at the average primary spectral energy (1.25 MeV) remaining at the indicated depths for a 1.25 MeV photon incident per cm² area. The degraded photon spectra at various depths are given by the curves from 0.05 to 1.25 MeV relative to the maximum values at the various depths. Areas under these curves represent photon energies occurring as scattered radiation (see Table III) (Bruce and Johns, 1960).

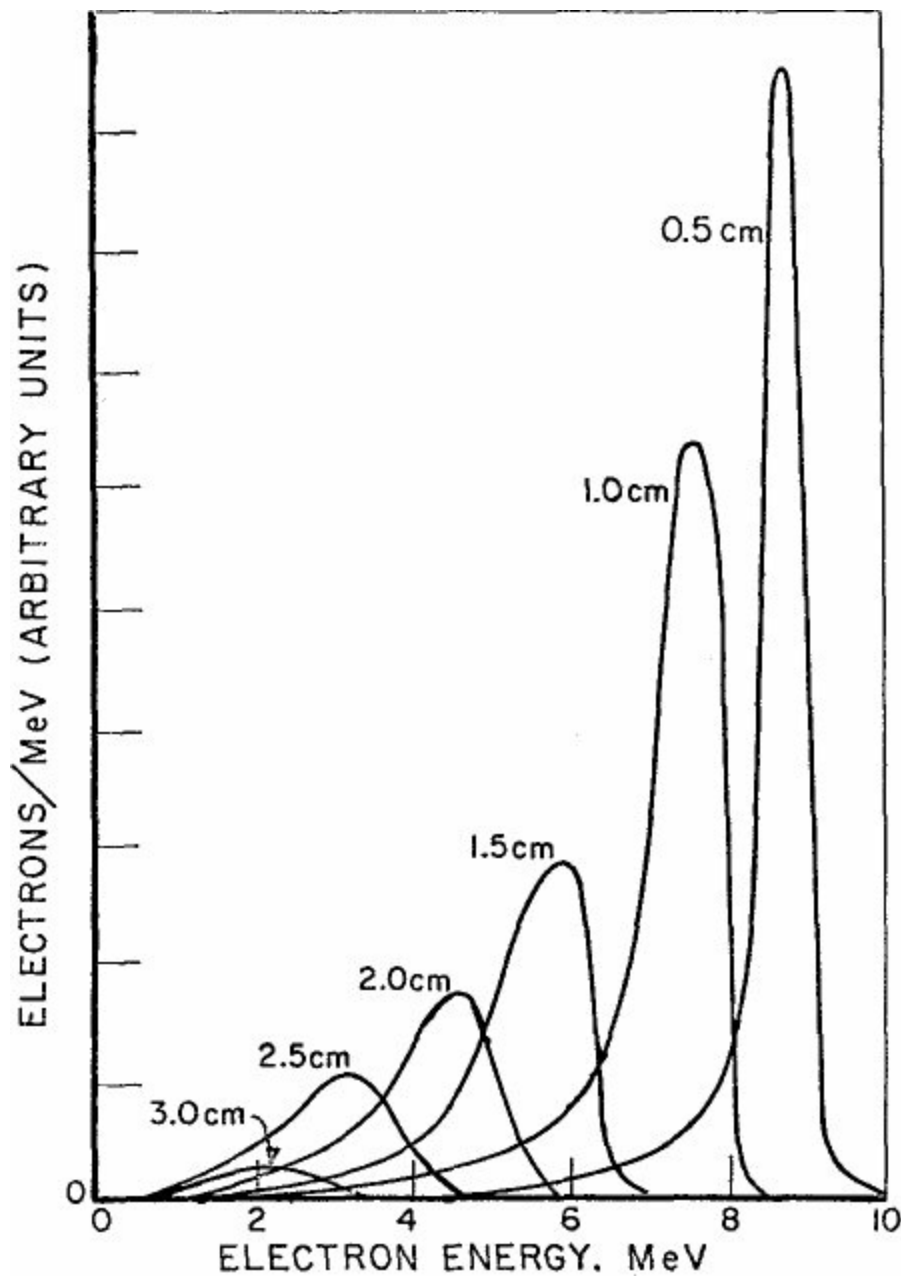

Figure 2. Relative electron spectra at various depths in water, due to penetration of perpendicularly incident 10-MeV electrons in a semi-infinite water absorber (Harder, 1965).

When calculating absorbed doses in a material based on measurements in another material, it is important to know the values of photon energy absorption coefficients and electron stopping powers for the materials and to know approximately the spectrum at the position of irradiation, because of the variation of energy deposition probabilities with the photon and electron spectral differences, especially at the lower radiation energies. These data can be useful in applying appropriate cavity theory corrections^{18,69}, when one converts absorbed dose as determined in a dosimeter material to the absorbed dose in water or in a given biological tissue.

Table I lists mass energy absorption coefficients for photons from 0.05 to 10 MeV, for water, muscle, various plastic and dyed plastic dosimetry systems, and cobalt-activated borosilicate glass. The values for the plastics and glass were obtained by using absorption coefficients of the atomic constituents according to their weight percent in each compound. Values are given for primary gamma-ray photon energies 0.66 MeV (cesium-137) and 1.25 MeV (cobalt-60) and for a typical average degraded photon spectrum due to irradiation at an 8-cm depth in a semi-infinite water absorber

irradiated with a large plaque source (see Figure 1 and Tables III and IV).

Table I. — Mass energy absorption coefficient, $\frac{\mu_{en}}{\rho}$ (cm²/g) (cm²/g) (Hubbell, 1969)

Photon Energy (MeV)	water	muscle	dyed polyamide (C ₇ H ₁₂ NO) _n	dyed cellophane (C ₆ H ₁₀ O ₅) _n	polymethyl methacrylate (C ₅ H ₈ O ₂) _n	polystyrene (C ₈ H ₈) _n	polycarbonate (C ₁₆ H ₁₆ O ₃) _n	dyed polychloro-styrene (C ₁₇ H ₁₈ Cl ₂) _n	polyvinyl vinylidene chloride (C ₄ H ₅ Cl) _n	polyvinyl chloride (C ₂ H ₃ Cl) _n	polyvinyl fluoride (C ₂ H ₃ F) _n	poly-tetra-fluoro-ethylene (C ₂ F ₄) _n	cobalt glass B (6.9%) O (53.3%) Na (7.5%) Al(5.0%) Si (27.0%) Co (0.3%)
0.05	0.0419	0.0431	0.0272	0.0337	0.0301	0.0236	0.0274	0.124	0.3080	0.2450	0.0369	0.0478	0.1120
0.1	0.0256	0.0256	0.0239	0.0238	0.0238	0.0231	0.0231	0.0336	0.0522	0.0465	0.0239	0.0231	0.0311
0.15	0.0277	0.0275	0.0271	0.0264	0.0266	0.0263	0.0261	0.0287	0.0327	0.0316	0.0258	0.0241	0.0271
0.2	0.0297	0.0294	0.0292	0.0282	0.0287	0.0286	0.0282	0.0290	0.0299	0.0295	0.0278	0.0257	0.0275
0.3	0.0319	0.0317	0.0317	0.0305	0.0310	0.0309	0.0305	0.0305	0.0298	0.0301	0.0300	0.0278	0.0287
0.4	0.0328	0.0325	0.0324	0.0313	0.0318	0.0318	0.0313	0.0311	0.0301	0.0304	0.0308	0.0284	0.0293
0.5	0.0330	0.0328	0.0329	0.0316	0.0322	0.0321	0.0316	0.0315	0.0302	0.0306	0.0311	0.0287	0.0293
0.6	0.0329	0.0325	0.0324	0.0313	0.0319	0.0318	0.0313	0.0310	0.0299	0.0302	0.0308	0.0283	0.0293
0.05-0.66 _a	0.0321	0.0319	0.0316	0.0306	0.0311	0.0309	0.0305	0.0317	0.0333	0.0327	0.0301	0.0279	0.0297
0.66 _b	0.0327	0.0323	0.0323	0.0311	0.0317	0.0316	0.0311	0.0308	0.0297	0.0300	0.0305	0.0280	0.0291
0.8	0.0321	0.0318	0.0317	0.0306	0.0311	0.0310	0.0306	0.0303	0.0290	0.0295	0.0300	0.0275	0.0286
1.0	0.0311	0.0306	0.0307	0.0295	0.0301	0.0300	0.0296	0.0293	0.0280	0.0285	0.0291	0.0267	0.0275
0.05-1.25 _c	0.0302	0.0299	0.0297	0.0288	0.0292	0.0290	0.0287	0.0298	0.0314	0.0308	0.0283	0.0264	0.0279
1.25 _d	0.0296	0.0293	0.0294	0.0283	0.0288	0.0287	0.0283	0.0280	0.0268	0.0273	0.0278	0.0256	0.0264
1.5	0.0285	0.0280	0.0281	0.0271	0.0275	0.0275	0.0270	0.0267	0.0255	0.0261	0.0265	0.0244	0.0250
2.0	0.0264	0.0257	0.0258	0.0248	0.0253	0.0252	0.0249	0.0247	0.0239	0.0242	0.0245	0.0255	0.0233
3.0	0.0234	0.0225	0.0225	0.0222	0.0220	0.0219	0.0217	0.0216	0.0210	0.0213	0.0213	0.0199	0.0206
4.0	0.0214	0.0204	0.0202	0.0198	0.0199	0.0198	0.0198	0.0198	0.0196	0.0198	0.0194	0.0181	0.0190
5.0	0.0200	0.0189	0.0187	0.0185	0.0184	0.0182	0.0182	0.0184	0.0186	0.0186	0.0180	0.0169	0.0181
6.0	0.0190	0.0178	0.0175	0.0176	0.0173	0.0171	0.0172	0.0174	0.0182	0.0180	0.0169	0.0161	0.0175
8.0	0.0176	0.0164	0.0161	0.0164	0.0158	0.0155	0.0157	0.0162	0.0174	0.0171	0.0157	0.0151	0.0168
10.0	0.0168	0.0155	0.0151	0.0156	0.0148	0.0145	0.0149	0.0155	0.0173	0.0167	0.0148	0.0145	0.0164

- For a typical degraded ¹³⁷Cs γ-ray spectrum (see Table IV).
- Primary ¹³⁷Cs γ-ray energy.
- For a typical degraded ⁶⁰Co γ-ray spectrum (see Table IV).
- Primary average ⁶⁰Co γ-ray energy.

Table II. — Mass Collision Stopping Power, MeV · cm² · g⁻¹ (Pages *et al.*, 1972; Berger and Seltzer, 1964, 1966)

Electron Energy (MeV)	water	muscle	dyed polyamide (C ₇ H ₁₃ NO) _n	dyed cellophane (C ₆ H ₁₀ O ₅) _n	polymethyl methacrylate (C ₅ H ₈ O ₂) _n	polystyrene (C ₈ H ₈) _n	polycarbonate (C ₁₆ H ₁₆ O ₃) _n	dyed polychloro-styrene (C ₁₇ H ₁₃ Cl ₂) _n	polyvinyl vinylidene chloride (C ₄ H ₅ Cl) _n	polyvinyl chloride (C ₂ H ₃ Cl) _n	polyvinyl fluoride (C ₂ H ₃ F) _n	poly-tetra-fluoro-ethylene (C ₂ F ₄) _n	cobalt glass B(6.9%) O(53.3%) Na(7.5%) Al(5.0%) Si (27.0%) Co(0.3%)
0.05	6.74	6.66	6.74	6.37	6.54	6.55	6.41	6.17	5.48	5.71	6.18	5.41	5.52
0.1	4.19	4.14	4.19	3.98	4.07	4.07	3.99	3.84	3.44	3.58	3.86	3.39	3.46
0.15	3.30	3.24	3.29	3.12	3.20	3.20	3.13	3.02	2.71	2.83	3.03	2.67	2.73
0.2	2.84	2.79	2.83	2.69	2.76	2.76	2.70	2.61	2.35	2.44	2.62	2.31	2.35
0.3	2.39	2.34	2.38	2.26	2.32	2.32	2.27	2.19	1.99	2.06	2.19	1.95	2.00
0.4	2.18	2.13	2.17	2.05	2.10	2.11	2.07	2.00	1.81	1.87	2.00	1.78	1.82
0.5	2.06	2.01	2.04	1.93	1.98	1.99	1.95	1.89	1.72	1.77	1.90	1.68	1.72
0.6	1.99	1.93	1.97	1.86	1.91	1.92	1.88	1.82	1.66	1.71	1.83	1.62	1.67
0.7	1.94	1.89	1.92	1.81	1.86	1.87	1.83	1.78	1.63	1.67	1.78	1.58	1.63
0.8	1.91	1.85	1.89	1.78	1.83	1.84	1.80	1.75	1.61	1.64	1.75	1.56	1.60
0.9	1.89	1.83	1.87	1.76	1.80	1.81	1.78	1.73	1.59	1.62	1.73	1.54	1.59
1.0	1.87	1.82	1.85	1.74	1.79	1.80	1.76	1.72	1.58	1.61	1.72	1.53	1.58
2.0	1.85	1.81	1.85	1.72	1.76	1.77	1.75	1.71	1.59	1.60	1.72	1.51	1.59
3.0	1.88	1.84	1.88	1.74	1.78	1.80	1.78	1.74	1.65	1.64	1.76	1.54	1.65
4.0	1.91	1.87	1.92	1.76	1.81	1.82	1.82	1.78	1.69	1.67	1.81	1.56	1.69
5.0	1.94	1.90	1.95	1.78	1.83	1.84	1.85	1.81	1.72	1.70	1.84	1.58	1.73
6.0	1.96	1.92	1.99	1.80	1.85	1.86	1.88	1.84	1.76	1.72	1.88	1.60	1.76
7.0	1.98	1.94	2.01	1.82	1.87	1.88	1.91	1.86	1.78	1.74	1.90	1.61	1.77
8.0	2.00	1.96	2.03	1.84	1.88	1.90	1.92	1.89	1.81	1.76	1.92	1.63	1.81
9.0	2.02	1.97	2.07	1.85	1.89	1.91	1.93	1.90	1.83	1.77	1.94	1.64	1.82
10.0	2.03	1.98	2.07	1.86	1.91	1.92	1.96	1.92	1.85	1.79	1.95	1.65	1.83

Table III. — Fraction of Primary Mean Photon Energy (1250 keV) and of Scattered Degraded Photon Energy (1250 to 50 keV) at Different Depths in Semi-infinite Water Target, Irradiated with Infinite Area Cobalt-60 gamma ray Plaque (Bruce and Johns, 1960)

Depth (cm)	Fraction of Primary Energy Remaining (1250 keV)	Fraction of Energy Degraded (1250 to 50 keV)
0	0.93	0.07
2	0.88	0.17
5	0.73	0.27
10	0.53	0.47
20	0.28	0.72
30	0.15	0.85

Table II lists mass collision stopping powers for electrons from 0.05 to 10 MeV, for water, muscle, various plastic and dyed plastic dosimetry systems, and cobalt-activated borosilicate glass. An electron spectrum is also degraded in its penetration through an absorbing medium (see Figure 2), so that it may be necessary when determining appropriate stopping powers to estimate the approximate average electron spectrum at a given depth in an irradiated medium. A convenient estimation of change in electron spectra with depth of electron penetration in a typical target is given by Harder³⁹.

Table IV. — Approximate Average Gamma-ray Spectra in Typical Water Target at 8 cm Depth (Bruce and Johns, 1960)

⁶⁰ Co γ-ray, Photon Energy (MeV)	¹³⁷ Cs γ-rays, Photon Energy (MeV)	Percentage
1.25	0.66	60%
0.20 — 1.25	0.20 — 0.66	30%
0.20	0.20	3%
0.15	0.15	3%
0.10	0.10	3%
0.05	0.05	1%

$$E_x = E_o \left(1 - \frac{x}{R_p} \right) \text{ at } x < 0.9 R_p$$

where E_x is the mean energy (keV) of electron spectrum at depths, x
 E_o is the energy of incident electrons
 x is the depth in the absorber
 R_p is the practical (or extrapolated) electron range.

Selected dosimetry systems

Table V lists a number of plastic and dyed plastic dosimetry systems, primarily those undergoing measurable optical absorption changes upon irradiation. Also listed are values of: density; nominal thickness; wavelengths for spectrophotometric analysis; the relationship between the change in optical density (absorbance) ΔA and absorbed dose, D ; approximate useful dose range; approximate precision limits of dose interpretation. In addition, brief comments are made about possible sources of error, and representative literature references are given. It may be seen that some systems have a useful response at dose levels too high to be of much use in sterilization (e.g., cellulose di- and triacetate, polyethylene terephthalate). Some are also more reproducible than others. It will be shown that other criteria such as atomic constituents, stability, temperature and rate independence of response, and ease of handling may also determine the usefulness of a given dosimeter system.

Table VI lists several typical glass dosimeters, in which photolytic darkening due to color center formation is used for radiation measurement, mainly in the $10^4 - 10^8$ rad range. Also listed are: the glass code name or source; constituents by weight percent; wavelength for spectrophotometric readout; characteristics of response (ΔA vs. D); approximate useful range; reproducibility; comments on stability; representative literature references.

These dosimeter glasses are generally one to a few millimeters thick. Two of the main problems with the glass systems are instability of the radiolytic image during storage after irradiation and the fact that glasses, primarily because of their higher atomic-number constituents (see Tables 1 and 2), have a radiation response different from that of biological systems. Spontaneous bleaching of color centers in most dosimeter glasses can be minimized somewhat by a post-irradiation heat treatment, as indicated in Table VI. Glass dosimeters are generally more sensitive to radiation when used in combination with photoluminescence readout (e.g., silver-activated phosphate glass dosimeters) and can be used over a much wider dose range ($1-10^9$ rads). By measuring the degradation of fluorescence intensity after irradiation to high doses, some radiophotoluminescent glasses can be used from 10^5 to 10^9 rads³³. More commonly, radiolytic darkening is measured over this dose range^{11,59,80}.

Table V. — Plastic and dyed plastic dosimeter systems

Dosimeter	Formula	Approx. Density (g/cm ³)	Approx. Thickness (mm)	Wavelengths for Spectrophot. (nm)	Characteristics of Response ΔA vs D	Approximate $\frac{\Delta A}{D \cdot d}$ (Mrad ⁻¹ ·mm ⁻¹)
Cellulose diacetate	(C ₁₈ H ₂₆ O ₁₃) _n	1.3	0.05	290, 320	Approximate linearity	0.11 at 290 nm 0.075 at 320 nm
Cellulose triacetate	(C ₂₄ H ₃₂ O ₁₆) _n	1.4	0.03	250, 270, 290	Approximate linearity	1.00 at 250 nm 0.16 at 290 nm
Cellulose acetate butyrate	(C ₁₅ H ₂₂ O ₈) _n	1.2	0.5	325	Linear to 10 Mrad	0.11 at 325
Dyed cellulose acetate	(C ₆ H ₁₀ O ₅) _n	1.3	0.25	437, 530	Approximately linear to 1 Mrad	0.16 at 437 nm 1.4 at 530 nm (at 3 Mrad)
Dyed cellophane	(C ₃ H ₁₀ O ₅) _n	1.4	0.025, 0.035	650, 655	Non-linear (bleaches)	1.2 at 650 nm 2.3 at 340 nm
Melamine	(C ₆ H ₁₂ NO ₂) _n	1.5	3.2	340, 380, 420	Non-linear	0.30 at 420 nm
Dyed polyamide	(C ₇ H ₃ NO) _n	1.1	0.025, 0.050	510, 550, 600	Approximately linear to 2 Mrad	7.0 at 540 nm 16 at 600 nm
Polycarbonate	(C ₁₆ H ₁₆ O ₃) _n	1.2	0.20 0.025	290, 300, 325	$\Delta A = aD + b(1 - e^{-cD})$ Approximately linear to 2 Mrad	0.56 at 290 nm 0.16 at 325 nm 4.0 at 430 nm 19 at 630 nm
Dyed polychlorostyrene	(C ₁₇ H ₁₈ Cl ₂) _n	1.3	0.050	430, 630	Approximately linear to 2 Mrad	0.12 at 330 nm
Polyethylene terephthalate	(C ₁₀ H ₈ O ₄) _n	1.4	0.040 0.080	325, 330	Approximately linear to 20 Mrad	
Polymethyl methacrylate	(C ₅ H ₈ O ₂) _n	1.2	1.0 3.0	305, 315	Approximately linear to 3 Mrad	0.25 at 305 nm
Dyed polymethyl methacrylate (red)	(C ₅ H ₈ O ₂) _n	1.2	3.2	615, 640	Approximately linear to 1 Mrad	0.86 at 615 nm 0.11 at 640 nm
Dyed polymethyl methacrylate (amber)	(C ₅ H ₈ O ₂) _n	1.2	1.0 3.0	603, 651	Approximately linear to 2 Mrad	0.34 at 603 nm 0.20 at 651 nm
Dyed polystyrene	(C ₈ H ₈) _n	1.05	3.0	610, 640	Linear	0.23 at 610 nm
Polytetrafluoroethylene	(C ₂ F ₄) _n	2.2	Varies	ESR	No free radicals $= 0.87 \times 10^{-3} D^{0.88}$	200 μmol/kg free rad. per Mrad
Dyed polyvinyl alcohol	(C ₂ H ₄ O) _n	1.3	0.06, 0.12, 0.26	525	Linear to 1 Mrad	5.0 at 525 nm
Polyvinylchloride	(C ₂ H ₃ Cl) _n	1.4	0.25	396, 480	Varies	Varies
Dyed polyvinylchloride	(C ₂ H ₃ Cl) _n	1.4	0.1	Varies	Varies	Varies
Polyvinylfluoride	(C ₂ H ₃ F) _n	1.6	0.1	315	Linear	0.56 at 315 nm
Polyvinyl-vinylidene Cl	(C ₄ H ₅ Cl ₂) _n	1.7	0.025	260	$D = 1.1 + 10^7 \cdot \Delta A$ (in rad)	6.8 at 260 nm
Tetrazolium salt in plastic	(C ₄₈ H ₄₈ O ₁₈ N ₅ Cl) _n	1.3	0.1	490	Approximately linear to 3 Mrad	1.5 at 490 nm
Cellulose diacetate	10 — 100	±10	Batch differences; slight fading; insensitive; high intens. rate dep.		Lavrentovich, 1969 Aiginger & Hubeny, 1965	
Cellulose triacetate	5 — 100	± 8	Batch differences; slight fading; insensitive; high-intens. rate dep.		Puig & Laizier, 1970	
Cellulose acetate butyrate	1 — 50	±10	Batch differences; fades at > 35°C; scratches easily		Rizzo & Krishnamurthy, 1969	
Dyed cellulose acetate	0.5 — 20	±10	Dose rate dependent; temperature dependent		Goldstein, 1970	
Dyed cellophane	0.5 — 15	±10	Uneven dye distrib.; nonlinear response; O ₂ dependent		Henley and Richman, 1956	
Melamine	0.05 — 10	±10	Batch difference; temperature and humidity dependent		Birnbaum <i>et al.</i> 1955	
Dyed polyamide	0.1 — 20	± 2	No rate dep.; UV sensitive; humidity dependent		McLaughlin <i>et al.</i> 1973	
Polycarbonate	1 — 50	± 2	Stable after 10 hours storage; batch differences; low intens. rate dep.		Richold <i>et al.</i> 1972	
Dyed polychlorostyrene	0.1 — 20	± 2	No rate dep; UV sensitive; slight instability; O ₂ dependent		Harrah, 1970 Bishop <i>et al.</i> 1973	
Polyethylene terephthalate	5 — 1000	± 5	Strongly rate dependent; unstable; batch differences; O ₂ dependent		Ritz, 1961	

Polymethyl methacrylate	0.1	—	5	± 3	Needs post-irradiation heat; batch differences; O ₂ dependent	Chadwick, 1971, 1973
Dyed polymethyl methacrylate (Red)	0.5	—	5	± 2	Light sensitive; high background absorbance; O ₂ dependent; unstable	Whittaker, 1970a, b
Dyed polymethyl methacrylate (Amber)	0.1	—	5	± 2	O ₂ dependent; unstable	Whittaker, 1970b
Dyed polystyrene	0.05	—	50	± 7	Batch differences; dose rate and temperature differences; unstable	Prokert & Stolz, 1970
Polytetrafluoroethylene	0.03	—	1000	±15	Poor reproducibility; O ₂ dependent	Judeikis <i>et al</i> , 1968
Dyed polyvinyl alcohol	0.01	—	3	± 5	Temperature and O ₂ dependent; unstable	Hübner, 1971a and b
Polyvinylchloride	0.5	—	6	± 5	Batch differences; O ₂ dependent; rate dependent; needs post-irradiated heat	Ilić-Popović, 1966 Artandi, 1970
Dyed polyvinylchloride	0.1	—	100	±12	Poor reproducibility; rate and temperature dependent; O ₂ dependent	Farrell & Vale, 1963
Polyvinylfluoride	1	—	30	± 5	No humidity dependence; stable after 7 hours; O ₂ dependent	Windley & Elleman, 1967
Polyvinyl-vinylidene Cl	0.1	—	10	± 5	Batch differences; O ₂ and temperature dependent	Harris and Price, 1961
Tetrazolium salt in plastic	0.5	—	50	± 3	Temperature and humidity dependent; unstable	Gierlach and Krebs, 1949 Grunewald & Schmidt-Lorentz, 1964 Taplin, 1964 Bredoux, 1972 Snow, 1974

Table VI. Glass Dosimeter Systems

Dosimeter Glass	Name	Constituents by Weight Percent	Wavelengths for Spectropho. (nm)	Characteristics of Response (ΔA vs. D)	Approx Useful Range (Mrad)	Approx Precision (%)	Comments on Stability	Sample Ref.
Ag-phosphate	Toshiba RPL glass	45% Al(PO ₃) ₃ 45% Li ₃ PO ₃ 7.3% Ag ₃ PO ₃ 2.7% B ₂ O ₃	313,400	linear	0.003— 0.3	±2	Requires 30 min. heat treatment at 200°C after irradiation to stabilize darkening	Cheka and Becker, 1968; Nicolae, 1973
Bi-Pb-As borate	Argonne, Si 104 glass	52% Bi ₂ O ₃ 24% B ₂ O ₃ 17% PbO 4.5% SiO ₂	515	non-linear	0.1 — 100	?	relatively stable on storage at room temperature	Bishay, 1961
Co-borosilicate	Bausch & Lomb F-0621 glass	57.8% SiO ₂ 22.3% B ₂ O ₃ 10.1% Na ₂ O 9.4% Al ₂ O ₃ 0.4% Co ₃ O ₄	400	non-linear	0.1 — 4.0	±2	unstable at higher absorbance values (for D > 0.05 Mrad)	Kreidl and Blair, 1956 & 1959
Cr-Mg	Schott DG 1 glass	SiO ₂ B ₂ O ₃ Na ₂ O CaO MgO trace Cr ₂ O ₃	490,550	non-linear	0.01 — 10	?	6% fading in one week	Frank and Stolz, 1969
Mn-As borate	Atomic Energy Estab. Cairo SB-257 glass	74% B ₂ O ₃ 7.8% Li ₂ O 7.0% As ₂ O ₃ 9.6% MnO 2.4% Al ₂ O ₃	515	two linear regions 0.01-0.2 Mrad 0.4-10 Mrad	0.01 — 1000	?	requires 1 hr. heat treatment at 130° C after irradiation to stabilize darkening	Bishay and Arafa, 1967
Mg metaphosphate	Schott	SiO ₂ Na ₂ O K ₂ O Al ₂ O ₃ Mg ₃ (PO ₄) ₂	525	non-linear	0.05 — 10	?	stable (~ 5% fading in one month)	Scharmann, 1961

Mg-Fe soda-lime silicate	Hungarian Commercial drawn soda lime silicate	71.7% SiO ₂ 13.8% Na ₂ O 11.4% CaO 1.6% K ₂ O 1.4% Al ₂ O ₃ trace MgO trace Fe ₂ O ₃	420,620	non-linear	0.01 — 4	±3	requires 15 min. heat treatment at 150°C after irradiation to stabilize darkening	Szentirmay, <i>et al.</i> , 1965
Sb-silicate	Battelle Memorial Institute, B - 1 glass	40.0% Sb ₂ O ₃ 37.5% SiO ₂ 11.4% K ₂ O 5.6% Na ₂ O 5.5% Al ₂ O ₃	400	non-linear	1 — 1000	?	requires 15 min. heat treatment at 125°C After irradiation to stabilize darkening	Hedden <i>et al.</i> , 1960

In Figures 3a through 3t, the changes in absorbance of various dosimeters due to irradiation, $\Delta A = A_i - A_0$ (where A_i is the absorbance after a given irradiation and A_0 is the absorbance before irradiation) are plotted as a function of wavelength, λ . These differential absorption spectra show broad absorption bands in the ultraviolet or visible part of the spectrum. In some systems, particularly polyvinyl chloride and polyvinyl fluoride, adjacent bands in the ultraviolet are formed by irradiation as was discussed earlier. Figures 3e and 3f indicate the variety of absorption spectra from the same irradiation of different manufacturers' batches of polyvinyl chloride and polymethyl methacrylate^{16,21,67,101}. These differences are due primarily to variable contents, such as plasticizers, antioxidants, etc. The vertical lines in these figures are placed at wavelength values at which spectrophotometric analysis for dosimetry is usually performed. In some instances these wavelengths are chosen away from absorption maxima, primarily because the value of ΔA is more stable in this part of the spectrum or because it enables the system to be used for higher dose values than is possible at the peak absorbance value. Curve 2 in Figure 3f is an example of spectral readings at different times after irradiation, showing that at $\lambda < 314$ nm there is an increase in absorbance after irradiation and at $\lambda > 314$ nm the absorbance decreases²¹.

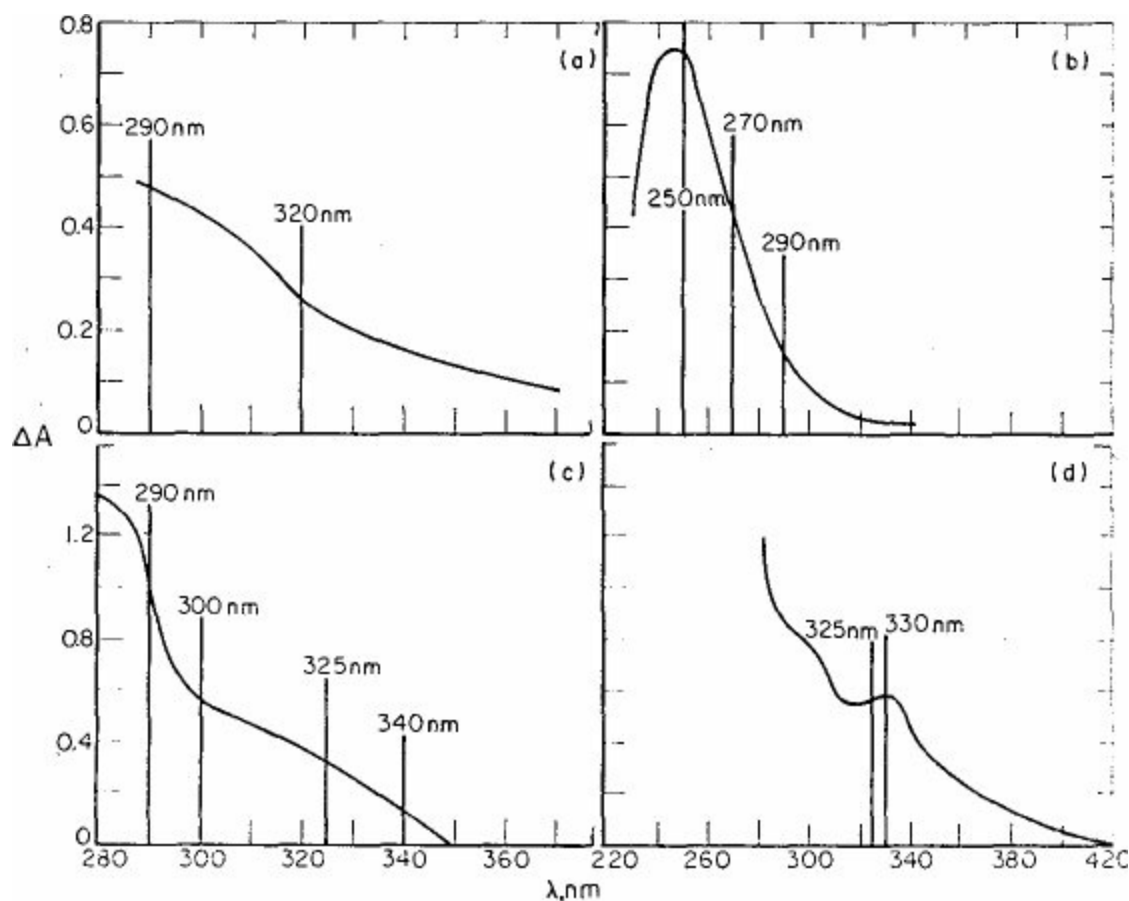

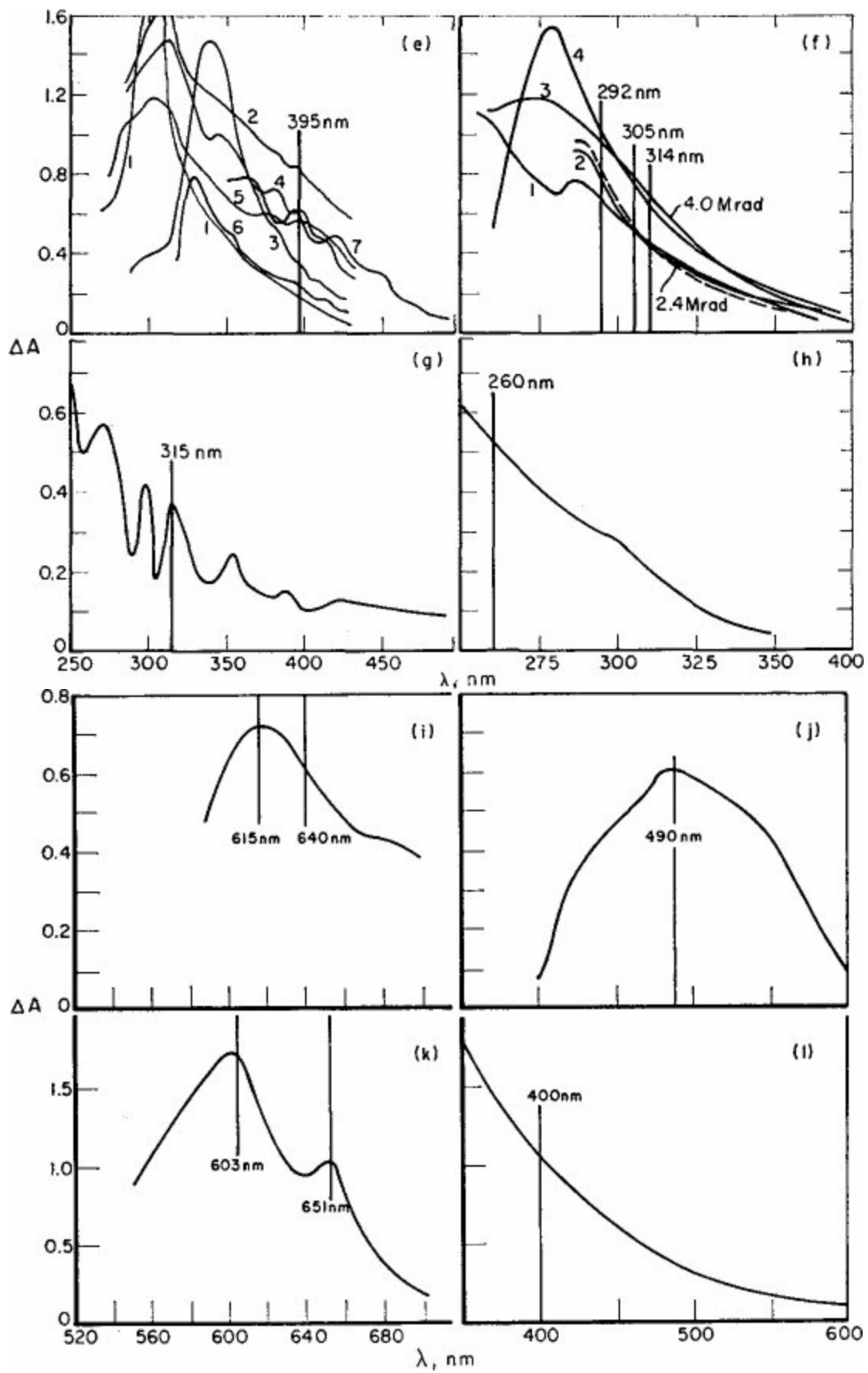

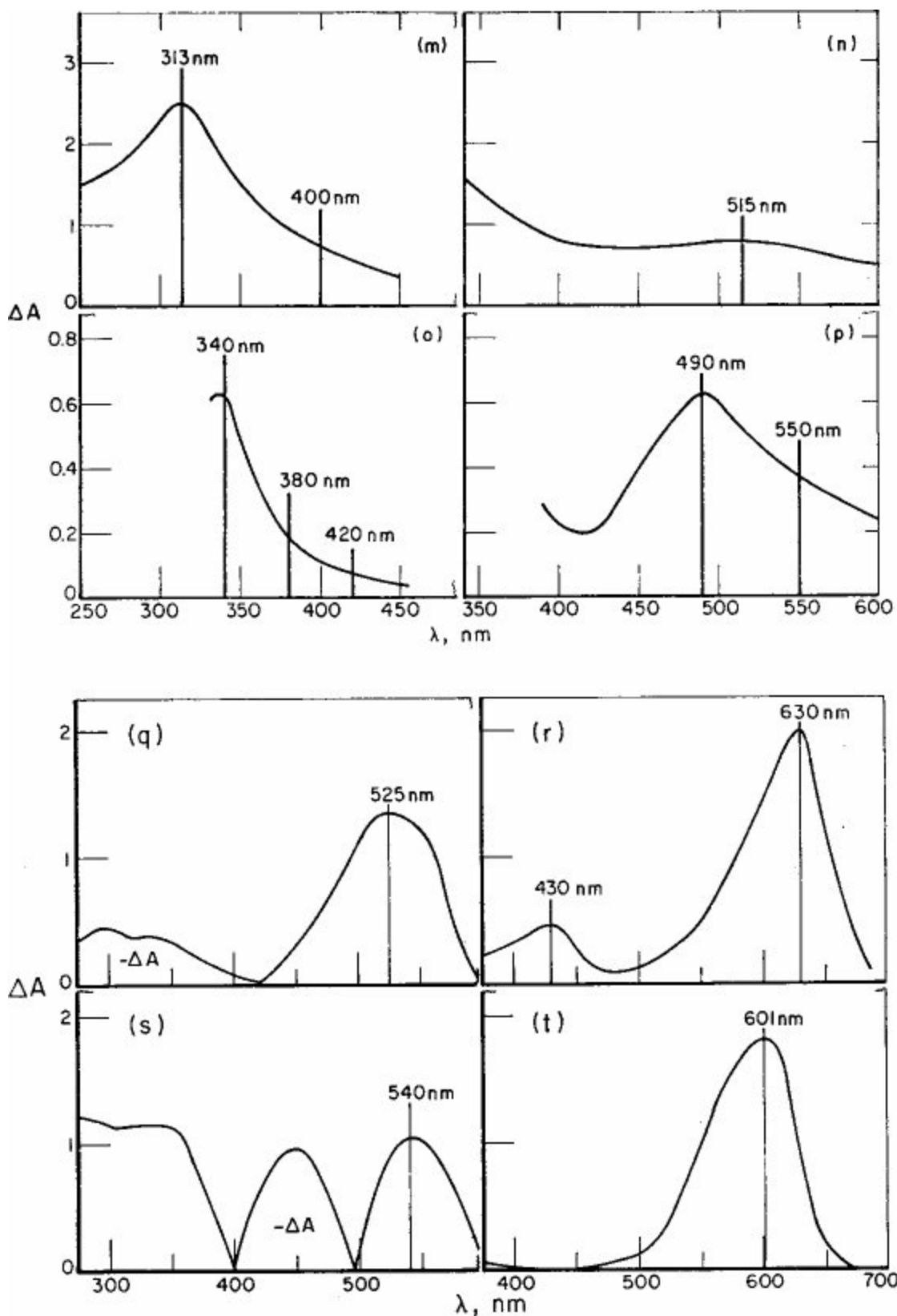
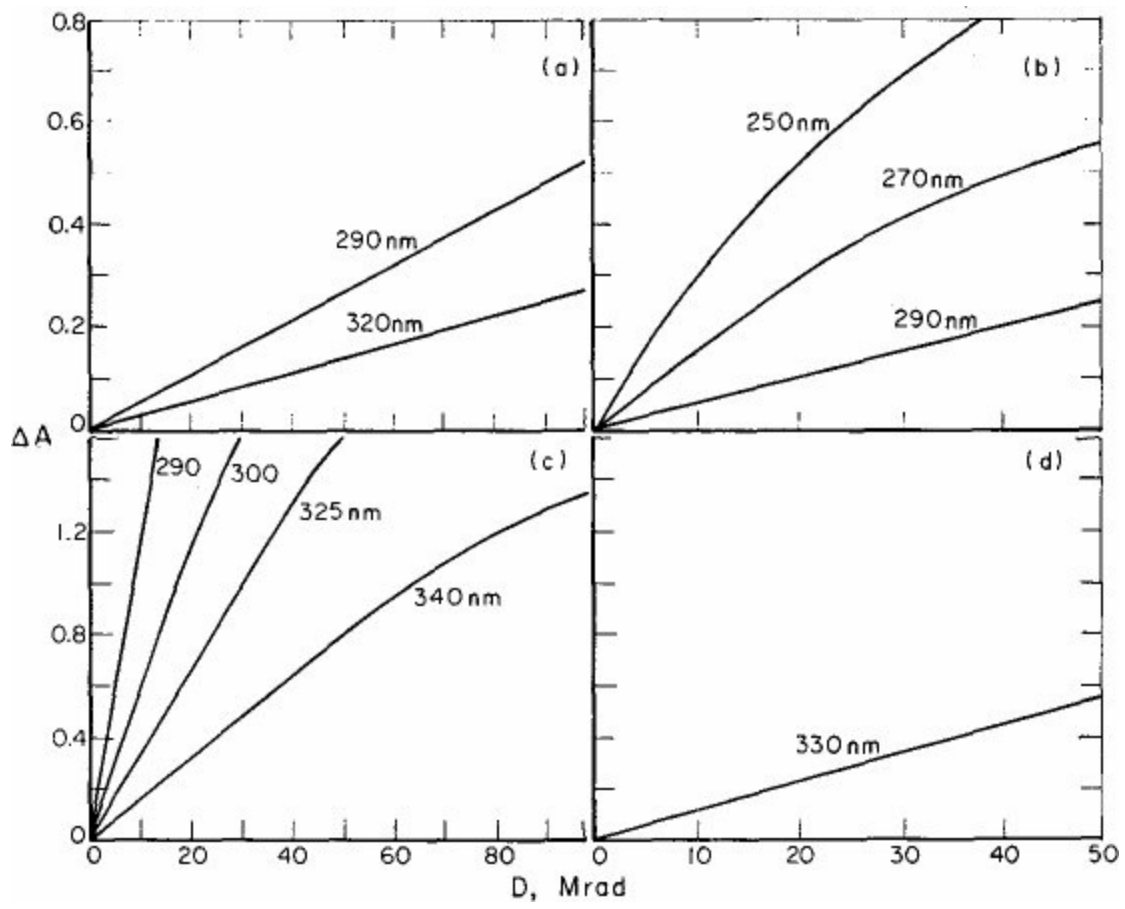

Figure 3. Absorption spectra of various dosimetry systems due to irradiation (change in optical absorbance, ΔA , versus wavelength, λ). Vertical lines represent suggested wavelengths for spectrophotometric measurement ΔA vs. absorbed dose.

- (a) Cellulose diacetate, 0.050 mm thick, irradiated to 90 Mrad with 2-MeV electrons (Aiginger and Hubeny, 1965).
 (b) Cellulose triacetate, 0.030 mm thick, irradiated to 30 Mrad with 120-kV X-rays (Hofmann, 1963).
 (c) Polycarbonate, 0.20 mm thick, irradiated to 8.35 Mrad with cobalt-60 gamma rays (Richold *et al.*, 1973).
 (d) Polyethylene terephthalate, 0.080 mm thick, irradiated to 50 Mrad with cobalt-60 gamma rays (Broskiewicz and Bulhak, 1973).
 (e) Various films of polyvinyl chloride, 0.25 mm thick, irradiated to 2.4 Mrad with cobalt-60 gamma rays (Broskiewicz and Bulhak, 1973; Maul *et al.*, 1961). Manufacturer: 1. Kalle; 2. Kunststoffwerk Staufen 3. Kunststoffwerk Staufen GMBH 000; 4. Astralon-Dynamit Nobel-Troisdorff; 5. Europhan MZ 200/523-Folien Fabrik Forchheim GMBH 001; 3. Kunststoffwerk Staufen GMBH 000; 4. Astralon-Dynamit Nobel-Troisdorff; 5. Europhan MZ 200/523-Folien Fabrik Forchheim GMBH; 6. Vynan, Cociété La Cellophan; 7. Bakelite 3310-Union Carbide.
 (f) Various batches of undyed polymethyl methacrylate, 1.0 mm thick, irradiated with cobalt-60 gamma rays: 1. Plexiglas™ II UVT-Röhm

- and Haas (Muller *et al.*, 1966); 2. Perspex™ HX-ICI Ltd. solid curve-immediately after irradiation, dashed curve dash after 24 hours stored in dark (Chadwick, 1973); 3. Perspex™ HX-ICI Ltd. (Whittaker, 1970b); 4. Perspex™ HX-ICI Ltd. (Broskiewicz and Bulhak, 1973).
- (g) Polyvinyl fluoride, 0.1 mm thick, irradiated to 5.0 Mrad with cobalt-60 gamma rays (Windley and Elleman, 1967).
 - (h) Polyvinyl vinylidene chloride, 0.025 mm thick, measured 50 minutes after irradiation to 3.0 Mrad with ⁶⁰Co γ -rays (Harris and Price, 1961).
 - (i) Red 4034 Perspex™ (polymethyl methacrylate dyed with Lacquer Red and Lithofor Yellow), 3.2 mm thick, irradiated to 3.0 Mrad with cobalt-60 gamma rays (Whittaker, 1970b).
 - (j) Tetrazolium salt in plastic, 0.1 mm thick, irradiated to 3.0 Mrad with 6-MeV electrons (Bredoux, 1972).
 - (k) Amber 3042 Perspex™ (polymethyl methacrylate dyed with Sudan I and Sudan III), 3.0 mm thick, irradiated to 3.0 Mrad with cobalt-60 gamma rays (Whittaker, 1970b).
 - (l) Cobalt-activated borosilicate glass F-0621-Bausch & Lomb, 1.5 mm thick, measured 1 hr after irradiation to 0.3 Mrad with 120-kV X-rays (Hofmann, 1963).
 - (m) Silver-activated phosphate glass — Toshiba RPL glass, 4.7 mm thick, irradiated to 0.1 Mrad with cobalt-60 gamma rays and heated 30 min at 200°C (Cheka and Becker, 1969).
 - (n) Manganese-arsenic borate glass SB-257, 1.0 mm thick, irradiated to 8.6 Mrad with cobalt-60 gamma rays and heated 60 minutes at 130°C. (Bishay and Arafa, 1967).
 - (o) Melamine plastic, 3.2 mm thick, irradiated to 0.08 Mrad with 11-MV X-rays (Birnbaum *et al.*, 1955).
 - (p) Chromium-magnesium borosilicate green glass, DG 1-Schott & Gen. Mainz, 4.0 mm thick, irradiated to 0.10 Mrad with ⁶⁰Co γ -rays (Frank and Stolz, 1969).
 - (q) Polyvinyl alcohol dyed with methyl orange, 0.30 mm thick, irradiated to 1.1 Mrad with cobalt-60 gamma rays (Hübner, 1971a).
 - (r) Polychlorostyrene dyed with malachite green methoxide - Far West Technology, Inc., 0.050 mm thick, irradiated to 2.5 Mrad with cobalt-60 gamma rays (Humphreys *et al.*, 1973).
 - (s) Buffered polyvinyl alcohol containing chloral hydrate and dyed with methyl orange, 0.10 mm thick, irradiated to 2.4 Mrad with 1.5-MeV electrons, (Hübner, 1971b).
 - (t) Polyamide (nylon) dyed with hexahydroxyethyl pararosaniline cyanide-Far West Technology, Inc., 0.046 mm thick, irradiated to 2.5 Mrad with cobalt-60 gamma rays (Humphreys *et al.*, 1973).

Typical response curves, ΔA vs absorbed dose, D , at appropriate wavelengths are given in Figures 4a through 4t. It should be kept in mind that these curves (and the corresponding absorption curves in Figures 3a-3t) are for a given batch of dosimeters in each case, and the response curve may vary in slope and shape when changing to another batch. This is the primary reason why the radiation response of these systems must be calibrated from one batch to the next. Because variations in response characteristics of any one batch may also change with age of the system, calibrations within a batch should also be made periodically. Such calibrations can be made easily in a cobalt-60 gamma-ray source at a position where the absorbed dose rate in given material is known accurately, using layers of a similar material around the dosimeter, thick enough to provide electronic equilibrium conditions^{22,99}. It is also possible to calibrate the response in combination with a standard measurement system such as a water, graphite, or metal calorimeter^{69,81,82} or a chemical solution (Fricke dosimeter)^{48,92}. The accuracy of a dosimeter of interest depends on the accuracy with which the calibration is performed and on the correctness of the conversion of absorbed dose in the calibration system to that in the dosimeter material^{56,57}.



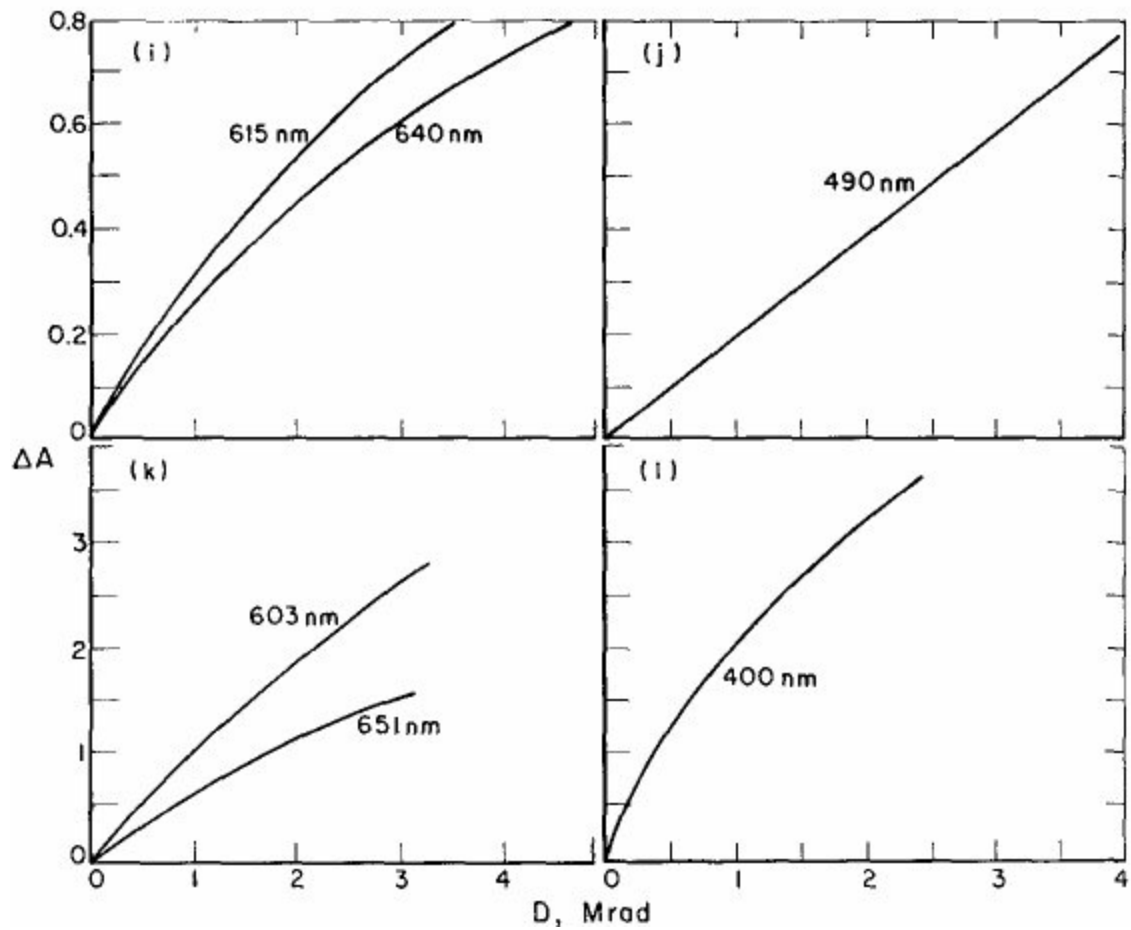
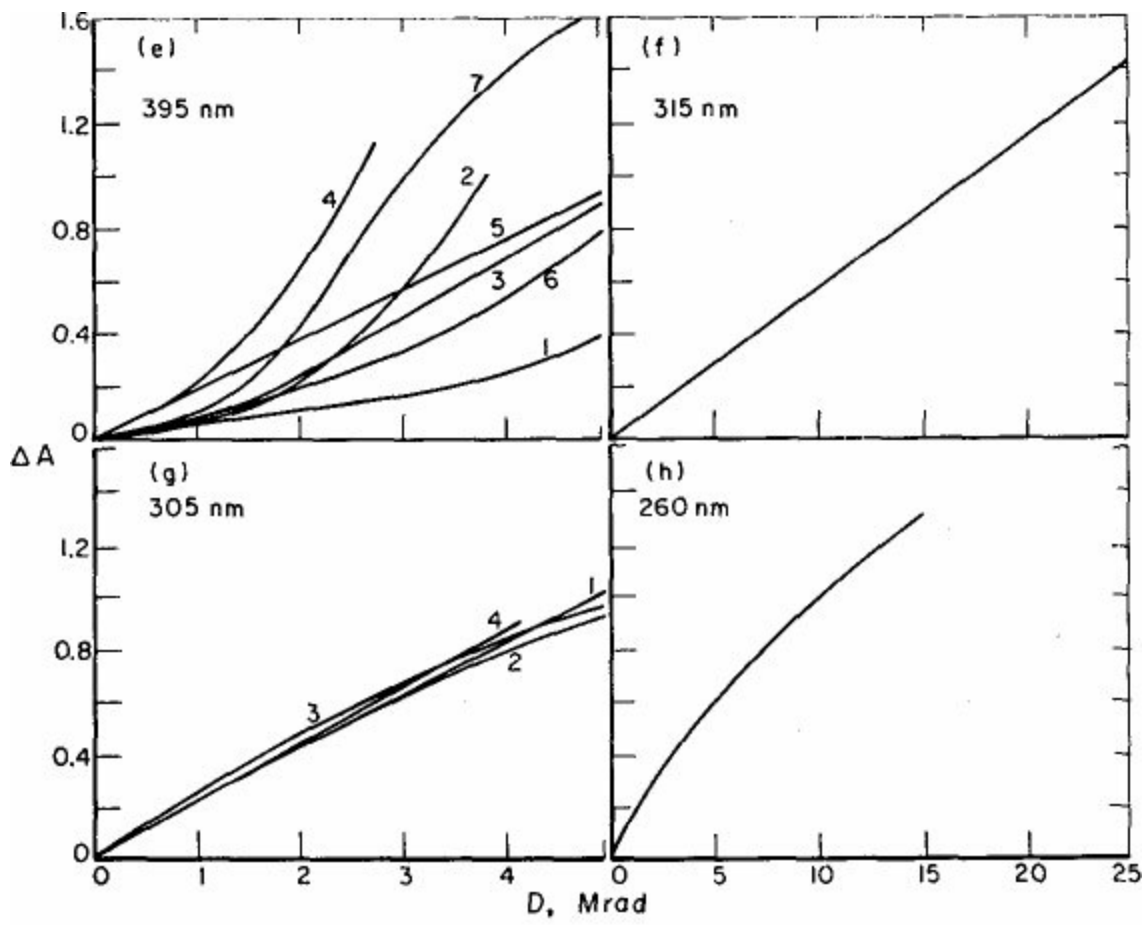

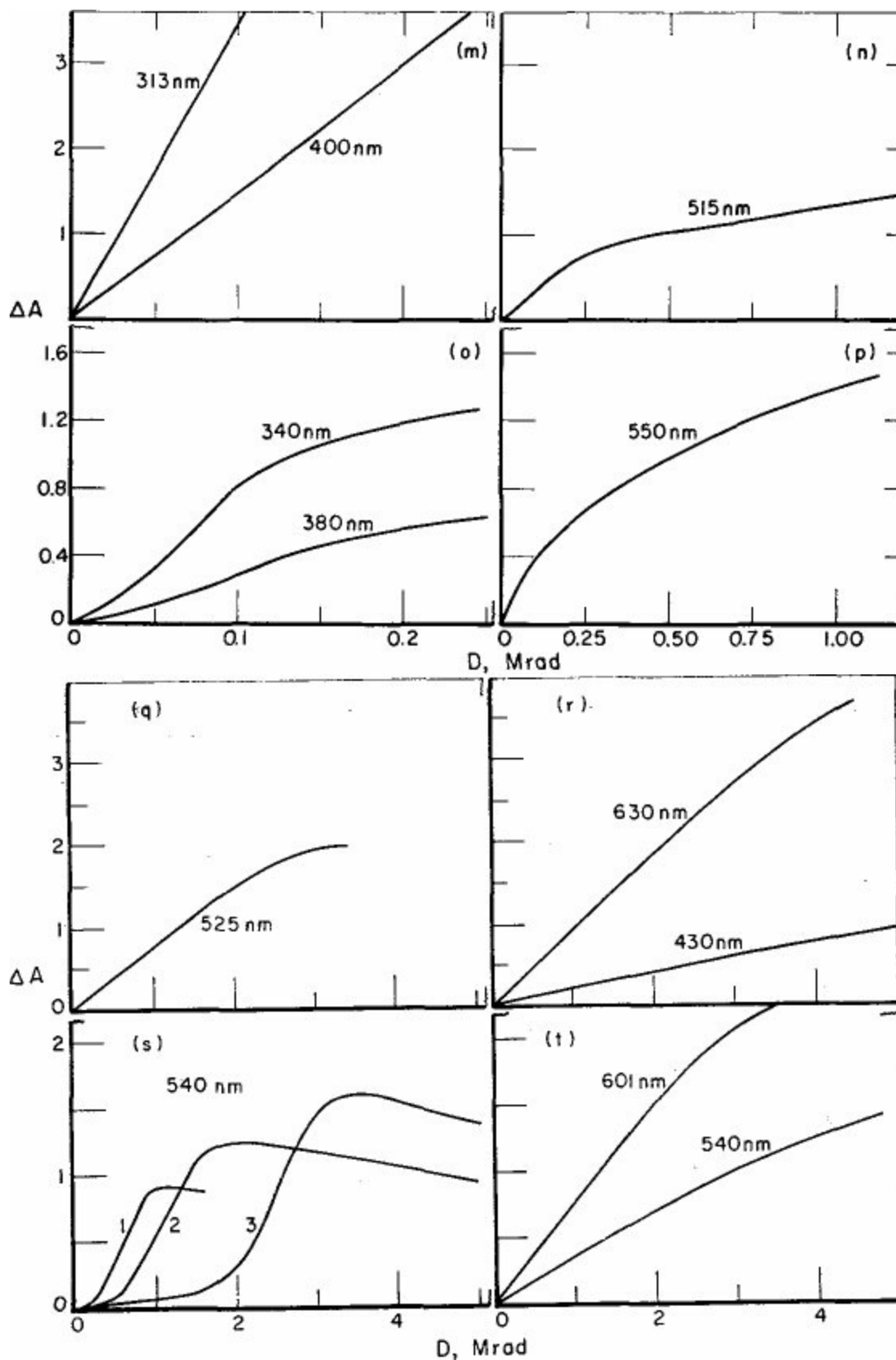

Figure 4. Response curves of various dosimetry systems due to irradiation (change in optical density, ΔA , at the indicated optical wavelengths as a function of absorbed dose, D).

(a) Cellulose diacetate, 0.050 mm thick, irradiated with 2-MeV electrons (Aiginger and Hubeny, 1965).

(b) Cellulose triacetate, 0.030 mm thick, irradiated with 120 kV X-rays (Hofmann, 1963).

(c) Polycarbonate, 0.20 mm thick, irradiated with cobalt-60 gamma rays (Richold *et al.*, 1973).

(d) Polyethylene terephthalate, 0.080 mm thick, irradiated with cobalt-60 gamma rays (Broskiewicz and Bulhak, 1973).

(e) Various films of polyvinyl chloride, 0.25 mm thick, irradiated with cobalt-60 gamma rays (Broskiewicz and Bulhak, 1973; Maul *et al.*, 1961). Manufacturer: 1. Kalle; 2. Kunststoffwerk Staufen GMBH 001; 3. Kunststoffwerk Staufen GMBH 000; 4. Astralon-Dynamit Nobel-Troisdorff; 5. Europhan MZ 200/523- Folien Fabrik Forschung GMBH; 6. Vynan-Société La Cellophan; 7. Bakelite 3310-Union Carbide.

- (f) Polyvinyl fluoride, 0.10 mm thick, irradiated with cobalt-60 gamma rays (Windley and Elleman, 1967).
- (g) Various batches of undyed polymethyl methacrylate, 1.0 mm thick, irradiated with cobalt-60 gamma rays. 1. Plexiglas™ II UVT-Röhm & Haas (Muller *et al.*, 1969); 2. Perspex™ HX-ICI, Ltd. (Chadwick, 1973); 3. Perspex™ HX-ICI, Ltd. (Whittaker, 1970b); 4. Perspex™ HX-ICI, Ltd. (Broskiewicz and Bulhak, 1973).
- (h) Polyvinyl vinylidene chloride, 0.025 mm thick, measured 50 minutes after irradiation with cobalt-60 gamma rays (Harris and Price, 1961).
- (i) Red 4034 Perspex™, polymethyl methacrylate dyed with Lacquer Red and Lithofor Yellow). 3.2 mm thick, irradiated with cobalt-60 gamma rays (Whittaker, 1970b).
- (j) Tetrazolium salt in plastic, 0.1 mm thick, irradiated with 6-MeV electrons (Bredoux, 1972).
- (k) Amber 3042 Perspex™ (polyethyl methacrylate dyed with Sudan I and Sudan III), 3.0 mm thick, irradiated with ⁶⁰Co γ-rays (Whittaker, 1970b).
- (l) Cobalt-activated borosilicate glass F-0621 - Bausch & Lomb, 1.5 mm thick, measured 1 hour after irradiation to 120-kV X-rays (Cheka 1963).
- (m) Silver-activated phosphate glass - Toshiba RPL glass, 4.7 mm thick, irradiated with cobalt-60 gamma rays and heated 30 minutes at 200°C (Cheka and Becker, 1969).
- (n) Manganese-arsenic borate glass SB-257, 1.0 mm thick, irradiated with cobalt-60 gamma rays and heated 60 minutes at 130°C (Bishay and Arafa, 1967).
- (o) Melanime plastic, 3.2 mm thick, irradiated with 11-MV X-rays (Birnbaum *et al.*, 1955).
- (p) Chromium-magnesium borosilicate green glass DG-1 - Schott & Gen. Mainz, 4.0 mm thick; irradiated with cobalt-60 gamma rays (Frank and Stolz, 1969).
- (q) Polyvinyl alcohol dyed with methyl orange, 0.30 mm thick, irradiated with cobalt-60 gamma rays (Hübner, 1971a).
- (r) Polychlorostyrene dyed with malachite green methoxide 0.050 mm thick - Far West Technology, Inc., irradiated with cobalt-60 gamma rays (Humphreys *et al.*, 1973).
- (s) Buffered polyvinyl alcohol containing chloral hydrate and dyed with methyl orange, 0.10 mm thick, irradiated with: 1. cobalt-60 gamma rays (1.5×10^3 rad/hr); 2. strontium-90:yttrium-90 beta rays (2.4×10^5 rad/hr); 3. 1.5 MeV electrons (6.1×10^8 rad/hr) (Hübner, 1971b).
- (t) Polyamide (nylon) dyed with hexahydroxyethyl pararosaniline cyanide - Far West Technology, Inc., 0.046 mm thick, irradiated with cobalt-60 gamma rays (Humphreys *et al.*, 1973).

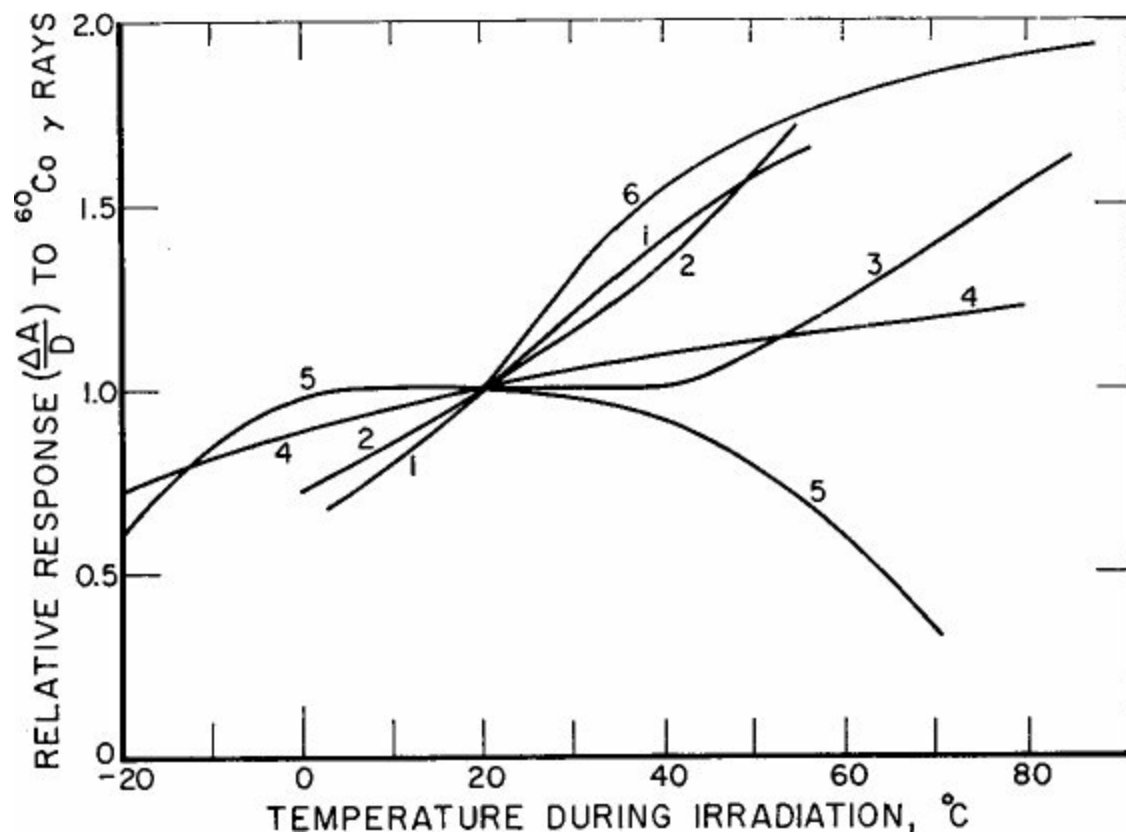

$$\left(\frac{\Delta A}{D}\right)$$

$$\frac{\Delta A}{D}$$

Figure 5. Response of dosimeters to cobalt-60 gamma radiation as a function of temperature during irradiation, relative to $\frac{\Delta A}{D}$ at 20°C: 1. Tetrazolium salt in plastic (Bredoux, 1972); 2. polyvinyl chloride (Maul *et al.*, 1961); 3. polycarbonate (Richold *et al.*, 1973); 4. polybromostyrene dyed with malachite green methoxide (Bishop *et al.*, 1973); 5. polychlorostyrene with malachite green methoxide (Bishop *et al.*, 1973); 6. polyvinyl alcohol dyed with methyl orange (Hübner, 1971a).

Another source of error is the variation of response with temperature during irradiation. Figures 5 and 6 show temperature dependence of the response of several dosimetry systems, in terms of the value of $\Delta A/D$ relative to the response at 20°C during irradiation. In general, there is an increase in response with temperature up to a certain temperature. In many systems, the variation of response as the temperature rises above room temperature during irradiation can cause appreciable error in the dose reading, unless a correction is made for this effect.

Evidence of the variation of dosimeter response with average dose rate is illustrated in Figure 7. These data were obtained by irradiating several dosimeters in air (with electronic equilibrium layers of nylon) at different average dose rates to 3 Mrad total dose¹⁴. The four irradiation conditions shown are (1) cobalt-60 gamma-rays (max. dose rate $\sim 10^3$ rad/sec in six separate steps of 0.5 Mrad each; (2) cobalt-60 gamma-rays (same max. dose rate) in a single irradiation; (3) scanned 10-MeV electrons (max. dose rate $\sim 10^{10}$ rad/sec, pulse rate 300 Hz, and scan rate 6 Hz) in six separate steps of 0.5 Mrad each; (4) scanned 10-MeV electrons (same specifications) in a single irradiation. The results indicate that for most systems, the dosimeter response is lowest at the highest average dose rate. In blue cellophane, however, this trend is reversed. The absence of appreciable dose-rate dependence is demonstrated for the dyed nylon system, which substantiates earlier findings that solid solutions of triamino triphenylmethane cyanide dyes in nylon or diamino triphenylmethane methoxide dyes in polyhalostyrenes have a response that is independent of dose rate^{24,32,54,68}. Most halogenated hydrocarbons combined with indicator dyes, however, such as certain "go-no go" visual dose sensors

used to indicate that a radiation sterilization dose level has been reached, have a marked dose rate and temperature dependence. Nevertheless, such color changes in dyed solid materials are convenient for indicating dose distributions in phantom materials⁷⁷.

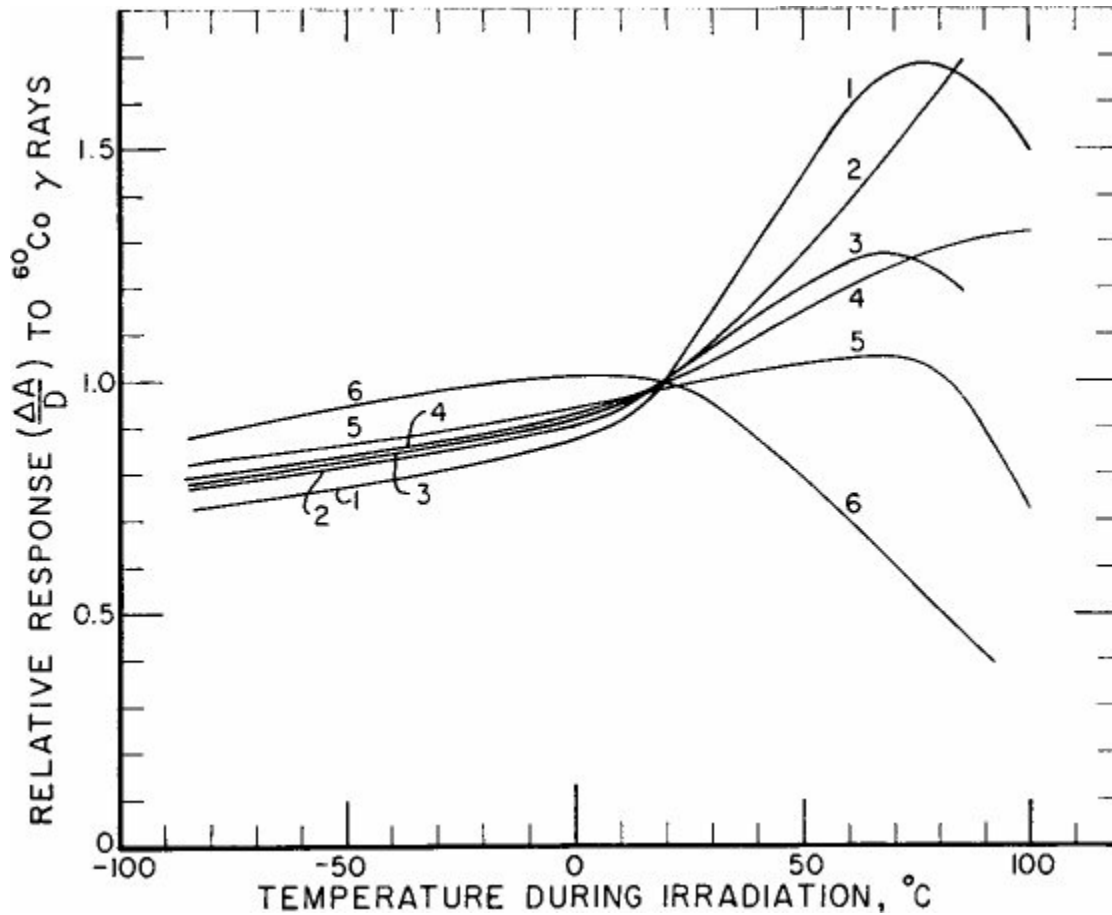

Figure 6. Response $\left(\frac{\Delta A}{D}\right)$ of dosimeters to cobalt-60 gamma radiation as a function of temperature during irradiation, relative to $\frac{\Delta A}{D}$ at 20°C: 1. Polyvinyl acetate-polyvinyl chloride dyed with pararosaniline cyanide; 2. gelatin dyed with pararosaniline cyanide; 3. polyvinyl butyral dyed with pararosaniline cyanide; 4. polyamide (nylon) dyed with hexahydroxyethyl pararosaniline; 5. polyvinyl pyrrolidone-polymethyl methacrylate-polyacrylonitrile dyed with hexahydroxyethyl pararosaniline cyanide (Rosenstein *et al.*, 1973); 6. blue cellophane.

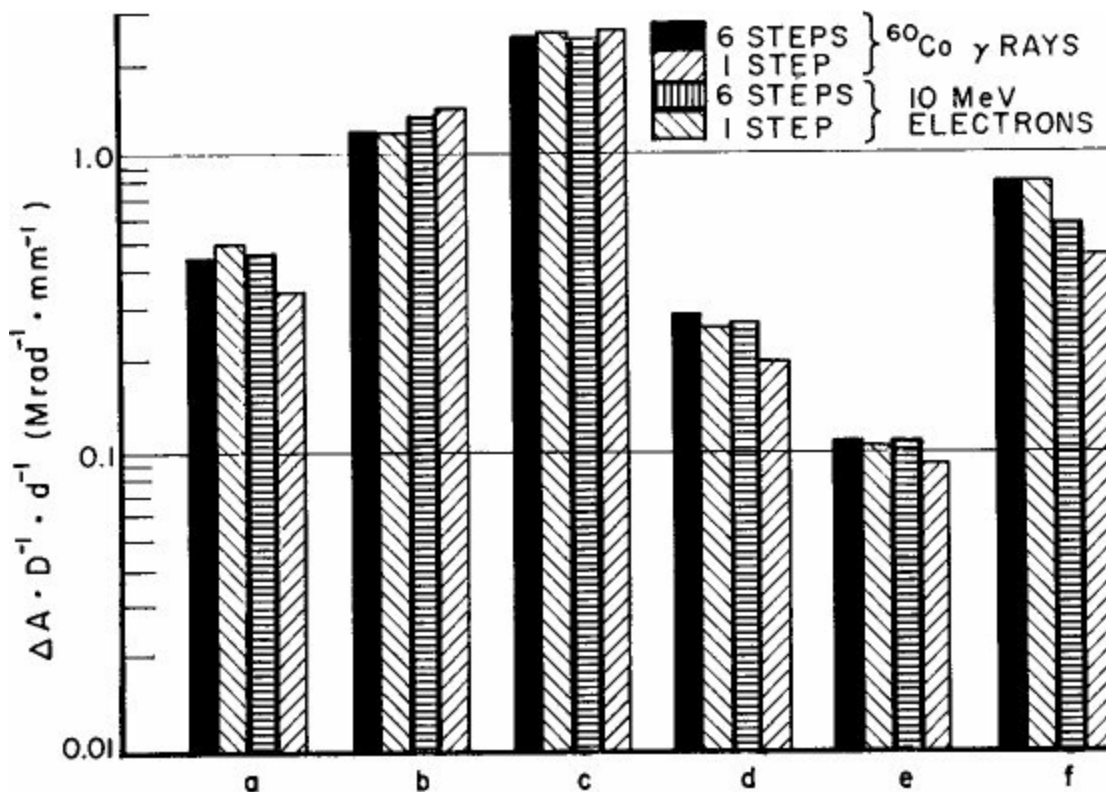

Figure 7. Response per unit thickness ($\Delta A \cdot D^{-1} \cdot d^{-1}$, where D is the absorbed dose in megarads and d is the dosimeter thickness in millimeters) of several solid dosimeters, for different conditions of irradiation cobalt-60 gamma radiation at maximum dose rate of $\sim 10^3$ rad/sec. in one irradiation of 3 Mrad or in six separate irradiations of 0.5 Mrad each; 10 MeV electrons maximum dose rate of $\sim 10^{10}$ rad/sec., pulsed at repetition rate of 300 Hz and scanned back and forth across the dosimeters at 6 Hz, using one irradiation of 3 Mrad or six separate irradiations of 0.5 Mrad each (Bjergbakke and Miller, 1974). Dosimeter systems:

- a. cellulose triacetate
- b. blue cellophane
- c. polyamide (nylon) dyed with hexahydroxyethyl pararosaniline cyanide
- d. undyed polymethyl methacrylate
- e. red dyed polymethyl methacrylate
- f. polyvinyl chloride

Summary

Many of the various solid dosimeters featured here are suitable for routine sterilization dosimetry and for measuring radiation dose distributions, if properly calibrated. Most of them have a radiation response to gamma-rays and electron beams fairly representative of that of biological systems (except perhaps when there is an appreciable fraction of the radiation spectrum below ~ 100 keV) since they consist of low atomic-number ingredients. They are rugged, easy to use, and in most cases, inexpensive. Only a few have a response with precision limits of less than ± 5 percent, and are not susceptible to large errors resulting from instability, non-uniformities, temperature, and dose-rate dependence.

Based on these factors and others mentioned earlier, some measurement systems for radiation sterilization dosimetry are polymethyl methacrylate and dyed polymethyl methacrylate (available under the trade names of HX-Perspex[™], Red or Amber Perspex[™] from the U.K. Panel on Gamma and Electron Irradiation, 35-37A Finsbury Square, London, EC2, U.K.), tetrazolium salt in plastic (under development at Kodak Pathé, France), polycarbonate films (being studied at Atomic Energy Research Establishment, Harwell, U.K.), and the radiochromic dyes in nylon and polychlorostyrene (available

from Far West Technology, Inc., 330 South Kellogg, Goleta, California 93017, U.S.A.). Others such as polyvinyl chloride, polyvinyl fluoride, blue cellophane, and various glasses are commercially available from various sources and may also be used, if the causes of error and imprecision are controlled and suitable corrections are made for instability and temperature, dose-rate dependence, and energy dependence of response.

References

1. Aiginger, H. and Hubeny, H. (1965). Vergleich der Ionisationskammer und der Extinktionsänderungsmessung zur Bestimmung der Electrontiefendosis, *Atomkernenergie* **10**, 479-483.
2. Artandi, C. (1973). Rigid Vinyl Film Dosimeter, in *Manual on Radiation Dosimetry* (Holm, N. W. and Berry, R. J., eds.) Marcel Dekker, New York, 353-356.
3. Atari, N. A. and Ettinger, K. V. (1974). Lyoluminescent tissue equivalent radiation dosimeter, *Nature* **247**, 193.
4. Bahr, G. F., Johnson, F. B. and Zeitler, E. (1965). The Elementary Composition of Organic Objects after Electron Irradiation, *Lab. Investigation* **14**, 377-383.
5. Becker, K. (1966a). Radiophotoluminescence Dosimetry — A Bibliography, *Health Phys.* **12**, 1376.
6. Becker, K. (1966b). *Photographic Film Dosimetry*, Focal Press, London.
7. Becker, K. (1973). *Solid-State Dosimetry*, Chem. Rev. Press, Cleveland, Ohio.
8. Berger, M. J. and Seltzer, S. M. (1964). Tables of Energy Losses and Ranges of Electrons and Positrons, *NASA SP-3012* Clearinghouse for Federal and Technical Information, Springfield, Va., U.S.A.
9. Berger, M. J. and Seltzer, S. M. (1966). Additional Stopping Power and Range Tables from Protons, Mesons, and Electrons, *NASA SP-3036*, Clearinghouse for Federal and Technical Information. Springfield, Va., U.S.A.
10. Birnbaum, M., Schulman, J. and Seren, L. (1955). Use of Melamine as an X-Radiation Detector, *Rev. Sci. Instr.* **26**, 457-459.
11. Bishay, A. M. (1961). A bismuth Lead Borate Glass Dosimeter for High-Level Gamma Measurements, *Phys. Chem. Glasses* **2** (2), 33.
12. Bishay, A. and Arafa, S. (1967). A Manganese Arsenic Borate Glass Dosimeter, *Bull. Amer. Ceram. Soc.* **46**, 1102-1109.
13. Bishop, W. P., Humpherys, K. C. and Randtke, P. T. (1973). Poly (halo) Styrene Thin-Film Dosimeters for High Doses, *Rev. Sci. Instr.*, **44**, 443-452.
14. Bjergbakke, E. and Miller, A. (1974). Atomic Energy Commission, Research Establishment Risø, Roskilde, Denmark (in preparation).
15. Bredoux, F. (1972). Film Dosimétrie pour Fortes Doses d'Irradiation, *Société Kodak Pathé Report*, Paris.
16. Broskiewicz, R. K. and Bulhak, Z. (1973). Plastic Film Dosimeters, in *Dosimetry in Agriculture, Industry, Biology, and Medicine*, International Atomic Energy Agency, Vienna, pp. 599-606.
17. Bruce, W. R. and Johns, H. E. (1960). The Spectra of X-Rays Scattered in Low Atomic Number Materials, *Brit. J. Radiol. Suppl.* No. 9, Brit. Inst. Radiol., London.
18. Burlin, T. E. (1970). The Theory of Dosimeter Response with Particular Reference to Ionization Chambers, Ch. 2 in *Manual on Radiation Dosimetry* (N. W. Holm and R. J. Berry, eds.) Marcel Dekker, New York.
19. Cameron, J. R. (1970). Radiophotoluminescence and Thermoluminescence Dosimetry, Ch. 5 in *Manual on Radiation Dosimetry* (N. W. Holm and R. J. Berry, eds.) Marcel Dekker, New York.
20. Chadwick, K. H. (1971). Radiation Effects and After Effects in the Clear Polymethyl Methacrylate Dosimeter, Doctoral Thesis, University of Utrecht, available from Centre for Agricultural Publishing and Documentation, Wageningen, The Netherlands.
21. Chadwick, K. H. (1973). The Choice of Measurement Wavelength for Clear HX-Perspex Dosimetry, in *Dosimetry in Agriculture, Industry, Biology and Medicine*, International Atomic Energy Agency, Vienna, pp. 563-568.
22. Chandler, L., Chadwick, K. H., Ehlermann, D. A. E., McLaughlin, W. L., Rizzo, F. X. and Takashima, Y. (1974). *Dosimetry for the Radiation Processing of Food*, International Atomic Energy Agency, Vienna, (in press).
23. Chapiro, A. (1962). *Radiation Chemistry of Polymeric Systems* (High Polymers, Vol. 15), Interscience, New York.
24. Chappell, S. E. and Humphreys, J. C. (1972). The Dose Rate Response of a Dye-Polychlorostyrene Film Dosimeter, *IEEE Trans. Nucl. Sci.* **NS-19**, 175-180.
25. Charlesby, A. (1960). *Atomic Radiation and Polymers*, Pergamon, London.
26. Cheka, J. S. and Becker, K. (1969). High-Level Glass Dosimeters with Low Dependence on Energy, *Nucl. Appl.* **6**, 163-167.
27. Dole, M., Editor (1972-73). *The Radiation Chemistry of Macromolecules*, Vols. I and II, Academic Press, New York.
28. Ellis, S. C. (1971). Problems in Spectrophotometry and Their Influence in Radiation Measurements, Symposium on *Radiation Dose and Dose Rate Measurements in the Megarad Range*, U.K. Panel on Gamma and Electron Irradiation, National Physical Lab., Teddington, Middlesex, U.K.
29. Farrell, J. J. and Vale, R. L. (1963). Radiation-Sensitive Paint Verifies Product Irradiation, *Nucleonics* **21** (11), 78-85.
30. Fowler, J. H. and Attix, F. H. (1966). Solid State Integrating Dosimeters, Ch. 13 in *Radiation Dosimetry*, Vol. II, 22nd ed., (F. H. Attix and W. C. Roesch, eds.) Academic Press, New York.

31. Frank, M. and Stolz, W. (1969). *Festkörperdosimetrie ionisierender Strahlung*, BSB B. G. Teubner, Leipzig.
32. Frankhauser, W. A. (1973). Measurement of the Radiation Response of a Radiochromic Dosimeter Exposed to a Pulsed Electron Beam Source, *EG&G Report No. 1183-5024*.
33. Freytag, E. (1971). Measurement of High Doses with Glass Dosimeters, *Health Phys.* **20**, 93-94.
34. Gierlach, Z. S. and Krebs, A. T. (1949). Radiation Effects on 2, 3, 5 Triphenyl Tetrazolium Chloride Solutions, *Amer. J. Roentgenol, Rad. Therapy* **62**, 559-563.
35. Goldstein, N. (1970). Cinemoid Color Films, in *Manual on Radiation Dosimetry*, (N. W. Holm and R. J. Berry, eds.) Marcel Dekker, New York, pp. 371-375.
36. Grünewald, Th. and Rumpf, G. (1965). Ein Einfaches Polyäthylen Dosimeter, *Atompraxis* **11**, 85-93.
37. Grünewald, Th. and Schmidt-Lorenz (1964). Über die Verwendung von Triphenyltetrazoliumchlorid zur Messung der Strahlendosisverteilung, *Atomkernenergie* **9**, 143-147.
38. Günther, P. Von der Horst, H. D. and Kronheim, C. F. (1928). Die Einwirkung von Röntgenstrahlen auf Chloroform und ähnliche Verbindungen, *Z. Elektrochem.* **34**, 616-625.
39. Harder, D. (1965). Berechnung der Energiedosis aus Ionisationsmessung bei Sekundärelektron-Gleichgewicht; Energiespektren schneller Elektronen in Verschiedener Tiefen, Symposium on High Energy Electrons, Proceedings (A. Zuppinger and Poretti, eds.) Springer-Verlag, Berlin, pp. 20-33.
40. Harrah, L. A. (1969). Chemical Dosimetry with Trans-Stilbene Doped Polystyrene Films, *Rad. Res.* **39**, 223-229.
41. Harrah, L. A. (1970). Chemical Dosimetry with Doped Poly (Halostyrene) Film, *Rad. Res.* **41**, 229-246.
42. Harris, K. K. and Price, W. E. (1961). A Thin Plastic Radiation Dosimeter. *Intern. J. Appl. Rad. Isotopes* **11**, 114-122.
43. Hedden, W. A., Kircher, J. F., and King, B. W. (1960). Investigation of Some Glasses for High-Level Gamma-Radiation Dosimeters, *J. Amer. Ceram. Soc.* **43**, 417-421.
44. Henley, E. J. and Richman, D. (1956). Cellophane Dye Dosimeter for 10^5 to 10^7 Roentgen Range, *Anal. Chem.* **28**, 1580-1582.
45. Holm, N. W. (1969a). Dosimetry in Industrial Processing, Ch. 33 in *Radiation Dosimetry*, Vol. III (F. H. Attix and E. Tochilin, eds.) Academic Press, New York.
46. Holm, N. W. (1969b). Dosimeters for Industrial Irradiation, in *Large Radiation Sources for Industrial Processes*, International Atomic Energy Agency, Vienna, pp. 555-566.
47. Holm, N. W. and Berry, R. J. (1970). *Manual on Radiation Dosimetry*, Marcel Dekker, New York.
48. Holm, N. W. and Zagorski, Z. P. (1970). Aqueous Chemical Dosimetry, Ch. 4 in *Manual on Radiation Dosimetry* (N. W. Holm and R. J. Berry, eds) Marcel Dekker, New-York.
49. Hofmann, E. G. (1963). Messung höher Röntgenstrahlendosen durch optische Absorption an Gläsern und Kunststoffen, *Kerntechnik* **5**, 439-445.
50. Hubbell, J. H. (1969). Photon Cross Sections, Attenuation Coefficients, and Energy Absorption Coefficients from 10 keV to 100 GeV, *NSRDS-NBS 29*, Superintendent of Documents, U.S. Government Printing Office, Washington, D.C. 20402.
51. Hübner, K. (1971a). Die Verwendung des Systems Methylorange/Polyvinylalkohol zur Dosimetrie ionisierender Strahlung, *Isotopenpraxis* **7**, 439-446.
52. Hübner, K. (1971b). Dosimetric Properties of a Threshold Dosimeter for the Radiation Sterilization at 2.5 Mrad, *Isotopenpraxis* **7**, 268-272.
53. Hübner, K. and Prokert, K. (1971). Farbstoffdosimetrie, *Isotopenpraxis* **7**, 43-50.
54. Humpherys, K. C. and Wilcox, R. L. (1969). Radiochromic Dosimetry and Rate Effects, *EG&G Report No. 1183-2218*.
55. Humphreys, J. C., Chappell, S. C., McLaughlin, W. L., and Jarrett, R. D (1973). Measurement of Depth-Dose Distributions in Carbon, Aluminum, Polyethylene, and Polystyrene for 10-MeV Incident Electrons, *NBS Report 73-413*, National Bureau of Standards, Washington, D.C. 20234.
56. ICRU (International Commission on Radiation Units and Measurements) (1969). Radiation Dosimetry: X Rays and Gamma Rays with Maximum Photon Energies Between 0.6 and 50 MeV, *ICRU Report 14*, ICRU, 7910 Woodmont Avenue, Washington, D.C. 20014.
57. ICRU (International Commission on Radiation Units and Measurements) (1972). Radiation Dosimetry: Electrons With Initial Energies between 1 and 50 MeV. *ICRU Report 21*, ICRU, 7910 Woodmont Avenue, Washington, D.C. 20014.
58. Ilić-Popović, J. (1966). The Use of Polyvinyl-Chloride Film for Electron Beam Dosimetry, *Risø Report No. 141*, Danish Atomic Energy Commission, Research Establishment Risø, Roskilde, Denmark.
59. Jeltsch, E. and Graf, W. (1968). Zur Gammadosismetrie an Kernreaktoren mit Dosimeter Gläsern, *Atomkernenergie* **13**, 425.
60. Judeikis, E. S., Hedgpeth, H. and Siegel, S. (1968). Free Radical Yields in Polytetrafluoroethylene as the Basis for a Radiation Dosimeter, *Rad. Res.* **35**, 247-262.
61. Keitkin, L. G. and Starodubtsev, S. V. (1933). *Proc. Tashkent Conf. Peaceful Uses At. Energy* Vol. I (AEC-tr-6398) p. 366.
62. Kreidl, N. J. and Blair, G. E. (1956; 1959). Recent Developments in Glass Dosimetry, *Nucleonics* **14** (1) 56-60; **17** (10), 58.
63. Kügler, I. and Scharmann, A. (1959). Dosimetrie Ionisierender Strahlung mit Kunststoffen, *Atomenergie* **4**, 23-27.
64. Lavrentovich, Ya. I., Yakimenko, G. S., Zverev, A. B. and Kabakchi, A. M. (1969). Separate Determination of Fast Neutron and Gamma-Radiation Doses by Polymer Films, *Sov. At. Energ.* **27**, 296-301.
66. Mallon, B. J. (1967). Penton Used as a Dosimeter for 4-15 keV X-Rays; X-Ray Degradation of Penton and its Potential Use as a

- Dosimeter for the 4-15 keV Range, *J. Poly. Sci.* **B5**, 977-981; **A6**, 2637-2652.
67. Maul, J. E., Holm, N. W. and Draganić, I. G. (1961). The Use of Polyvinyl-Chloride Film for Co-60 Dosimetry, *Risø Report 31*, Danish Energy Commission, Research Establishment Risø, Roskilde, Denmark.
 68. McLaughlin, W. L. (1970). Films, Dyes, and Photographic Systems, Ch. 6 in *Manual on Radiation Dosimetry* (N. W. Holm and R. J. Berry, eds.) Marcel Dekker, New York.
 69. McLaughlin, W. L., Hjortenber, P. E. and Radak, B. B. (1973). Absorbed Dose Measurements with Thin Films, in *Dosimetry in Agriculture*, Atomic Energy Commission, Research Establishment Risø, Roskilde, Vienna, pp. 577-597.
 70. McLaughlin, W. L., Hjortenber, P. E. and Batsberg Pedersen, W. (1974). Low-Energy Scanned Electron-Beam Distributions in Thin Layers, *Int. J. Appl. Rad. & Isotopes* (in press).
 71. McLaughlin, W. L. and Hussmann, E. K. (1969). The Measurement of Electrons and Gamma-Ray Dose Distributions in Various Media, in *Large Radiation Sources for Industrial Processes*, International Atomic Energy Agency, Vienna, pp. 579-590.
 72. Muller, A. C. (1970). The "n" and "p" Solar-Cell Dose Rate Meter; The "p" and "n" Solar-Cell Integrating Dosimeter, in *Manual on Radiation Dosimetry* (N. W. Holm and R. J. Berry, eds.) Marcel Dekker, New York, pp. 423-433.
 73. Muller, A. C. Rizzo, F. X. and Hogk, R. B. (1966). The Measurement of Megarad Doses of Cobalt-60 Gamma Rays with Ultraviolet Transmitting Lucite, *BNL 985 (T417)* Brookhaven National Laboratory, Upton, New York 11973.
 74. Nicolae, M. (1973). Systemes Dosimetriques Fondes sur les Effets Optiques des Rayonnements dans les Solides, in *Dosimetry in Agriculture, Industry, Biology, and Medicine*, International Atomic Energy Agency, Vienna, pp. 555-561.
 75. Pages, L., Bertel, E., Joffre, H. and Sklavenitis, L. (1972). Energy Loss, Range, and Bremsstrahlung Yield for 10-keV to 100-MeV Electrons in Various Elements and Chemical Compounds, *Atomic Data* **4**, 1-127.
 76. Parker, R. P. and Morely, B. J. (1967). Silicon Junction Surface Barrier Detectors and Their Application to the Dosimetry of X- and Gamma-Ray Beams, in *Solid State and Chemical Dosimetry in Medicine and Biology*, International Atomic Energy Agency, Vienna, pp. 167-183.
 77. Potsaid, M. S. (1963). Dosimeters: Solid "Phantom." in *Encyclopedia of X-Rays and Gamma-Rays* (G. L. Clark, ed.) Reinhold, New York, pp. 279-289.
 78. Prokert, K. and Stolz, W. (1970). Dosimetrie ionisierender Strahlung mittels fester Farbstoffsysteme, *Isotopenpraxis* **6**, 325-330.
 79. Puig, J. R. and Laizier, J. (1970). Utilisation du Triacetate de Cellulose pour la Dosimetrie Megarad des Gammas et des Electrons, Paper No. 342 N/J1/J1, Meeting on *Industrial Radiation*, Grenoble, Dec., 1970.
 80. Pye, L. D., Hensler, J. R. and Snyder, A. W. (1964). Paper at Special Tech. Conf. on Nucl. Radiation Effects, Seattle, Washington.
 81. Radak, B. B., Hjortenber, P. E. and Holm, N. W. (1973). A Calorimeter for Absolute Calibration of Thin-Film Dosimeters in Electron Beams, in *Dosimetry in Agriculture, Industry, Biology, and Medicine*, International Atomic Energy Agency, Vienna, pp. 311-318.
 82. Radak, B. B. and Marković, V. (1970). Calorimetry, Ch. 3 in *Manual on Radiation Dosimetry* (Holm, N. W. and Berry, R. J. eds.) Marcel Dekker, New York.
 83. Radovsky, D. A. and Brumberger, H. (1967). Electron-beam dosimetry using the radiation induced fluorescence of polyethylene, *Nature* **216**, 469-470.
 84. Richold, P. H. C. V., Douglas, J. A., Marshall, M. and Gibson, J. A. B. (1973). A megarad plastic film dosimeter, *Phys. Med. Biol.* **18**, 665-672.
 85. Ritz, V. H. (1961). A note on Mylar film dosimetry, *Radiat. Res.* **15**, 460-466.
 86. Rizzo, F. X. and Krishnamurthy, K. (1969). Cellulose acetate butyrate dosimeter, *Trans. Am. Nucl. Soc.* **12**, (1), 61-62.
 87. Rosenstein, M., McLaughlin, W. L. and Levine, H. (1974). A thermosetting radiation-sensing gel for small-volume dosimetry, *Microdosimetry*, 4th Symposium, Euratom, Brussels (in press).
 88. Salovey, R. (1973). Poly (vinyl chloride), Ch. 3 in *The Radiation Chemistry of Macromolecules*, Vol. II (Dole, M., ed.) Academic Press, New York.
 89. Scharmann, A. (1961). Dosimetry of large doses of radiation by coloration or decoloration of glasses and plastics, in *Selected Topics in Radiation Dosimetry*, International Atomic Energy Agency, Vienna, pp. 511-519.
 90. Schenkel, J. (1965). Die durch Bestrahlung an Polymeren erreichbaren Effekte, *Chimia* **19**, 36-42.
 91. Schulman, J. H., Etzel, H. W. and Allard, J. G. (1957). Application of luminescent changes in organic solids to dosimetry, *J. Appl. Phys.* **28**, 792-795.
 92. Sehested, K. (1970). The Fricke dosimeter, in *Manual on Radiation Dosimetry* (Holm, N. W. and Berry, R. J. eds.) Marcel Dekker, New York, pp. 313-317.
 93. Snow, E. T. (1974). An evaluation of Kodak's experimental "Special Megarad Dosimetry Material", *Sandia Laboratories Report SLA-73-0991*, Albuquerque, N.M., U.S.A.
 94. Stolz, W. (1972). *Strahlensterilisation — Grundlagen und Anwendungen in Medizin und Pharmazie*, J. A. Barth, Leipzig.
 95. Swisher, J. A. and Coates, A. D. (1961). A study of the dosimetric properties of low-density polyethylene, *Ballistic Res. Labs. Memo. Rep. No. 1336*, Aberdeen Proving Ground, Maryland.
 96. Szentirmay, Z. S., Dézsi, Z., Patkó, J. (1965). Commercial sodium glass as a megaroentgen dosimeter, *Acta Univ. Debrecen. de Ludovico Kossuth Nom. Ser. Phys. et Chim.* **B** 33-40.
 97. Taimuty, S. I. (1959, 1962). Obtaining a system of dosimetry, Stanford Res. Inst. Final Reports for Quartermaster Food and Container

Inst. Armed Forces, U.S. Army Quartermaster Corps, *Publ. No. PB142511*, U.S. Department of Commerce, Office of Technical Services, Washington, D.C.

98. Taplin, G. V. (1964). Development of solid state plastic radiation dosimeter, *TID-4203*. Res. and Dev. in Progress, U.S. AEC Div. Biol. & Med.
99. Weiss, J. and Rizzo, F. X. (1970). Cobalt-60 dosimetry in radiation research and processing, Ch. 9, in *Manual on Radiation Dosimetry* (Holm, N. W. and Berry, R. J., eds.) Marcel Dekker, New York.
100. Whittaker, B. (1970a). Red Perspex dosimetry, in *Manual on Radiation Dosimetry* (Holm, N. W. and Berry, R. J., eds.) Marcel Dekker, New York, pp. 363-369.
101. Whittaker, B. (1970b). Recent developments in poly (methyl methacrylate) dye systems for megarad dosimetry, in *Radiation Dose and Dose Rate Measurements in the Megarad Range, Proc. Symposium*, U.K. Panel on Gamma and Electron Irradiation, Nat. Phys. Lab., Teddington, pp. 11-17.
102. Windley, W. C. and Elleman, T. S. (1967). Gamma ray dosimetry with polyvinyl-fluoride, *J. Nucl. Energy* **21**, 803-808.

Liquid Chemical Dosimeters

I. Draganić

Boris Kidrič Institute of Nuclear Sciences, Beograd - Yugoslavia

Abstract: *Some basic aspects of radiation-induced chemical changes in liquids are considered from the point of view of absorbed-dose measurements. Present status and current tendencies in the kilorad-to-megarad dose range are reviewed. It has been concluded that the basic problem in developing chemical dosimeters for large-dose range presents our lack in understanding and controlling of reaction mechanisms in liquids irradiated at kilorad-to-megarad dose region.*

Radiation-Induced Chemical Changes in Liquids and the Amount of Radiation Energy Absorbed

Interaction of radiation with liquid

When ionizing radiation passes through a liquid it loses its energy by interactions with atoms and molecules of absorbing medium. Along the radiation paths originate the ejected electrons and ionized and excited species. They lead to the formation of thermalized, chemically active, species such as solvated electrons, ions, free-radicals and radical-ions. These entities react among themselves and with surrounding molecules, in processes leading to chemical changes of irradiated liquid.

There is an essential difference in spatial distribution of active species in thermally or photochemically initiated processes and those induced by ionizing radiation.¹ If a process is initiated thermally or photochemically, then the distribution of active species is homogeneous in space. In radiation-induced reactions these species are produced only along the track of incident particle, and it is only after they have diffused throughout the reaction volume that we have conditions compatible with homogeneous kinetics of classical chemical reactions. The type, energy and intensity of radiation are important for the early processes, as well as for later chemical changes in irradiated liquids, because of various non-homogeneous spatial distributions of primary events they produce. In a greatly simplified picture one can say that the active species are produced closer together as the velocity of the incident ionizing particle decreases. At low primary energies, or high radiation intensities, they are so close that the active species can be considered as situated in roughly finite cylindrical regions. These facts explain why, for a given amount of radiation energy absorbed, the amount of radiation-induced chemical change depends on the type, energy and intensity of radiation. In searching for a chemical dosimeter we are looking for a radiation-induced chemical process where the amount of change, proposed as a measure of dose, is independent over a wide range of these parameters. Or, if this is not possible, the dependences must be well established and correlated by simple expression.

Irradiated water as an example

The sequence of events occurring in irradiated water is used here as an illustration, as probably one

of the best understood topics in radiation chemistry of liquids.² Also, water is an important constituent in many liquid dosimeters. The overall process starts with the bombardment of water by the radiation and terminates with the reestablishment of chemical equilibrium. The incident radiation produces, at about 10^{-15} sec

(or less), *ionization*

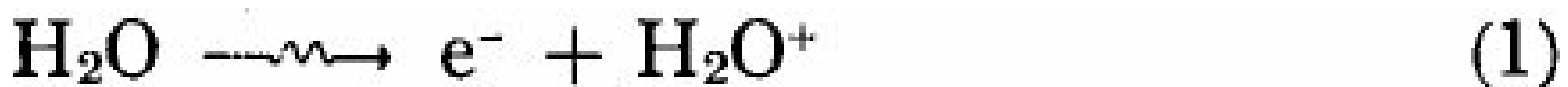

as well as *excitation*



Electrons ejected in reaction (1) become thermalized



and hydrated



at about 1 picosecond (1×10^{-12} sec) after the passage of radiation. The H_2O^+ ions undergo a fast (10^{-14} sec) *proton transfer reaction* with neighboring water molecules,



The *dissociation of excited water* molecules gives (10^{-13} sec.) the hydrogen atom and hydroxyl radical as the main products



and, eventually, some molecular hydrogen or low yield of hydrated electron. The reactions (1)-(6) are too fast to be directly observable. Competition kinetic experiments offer, however, some indirect evidence in the favor of reaction (4). The situation in irradiated water, picosecond after the passage of radiation, can be presented,

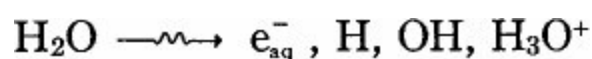

These species were identified by physico-chemical method and the rate-constants of their reaction accurately determined. Some of the more important, well established, reactions are the following:

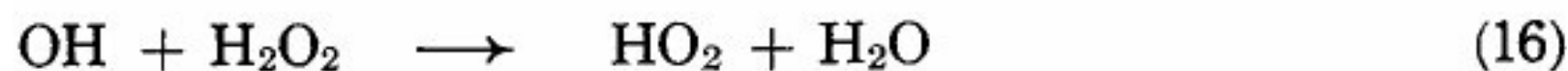
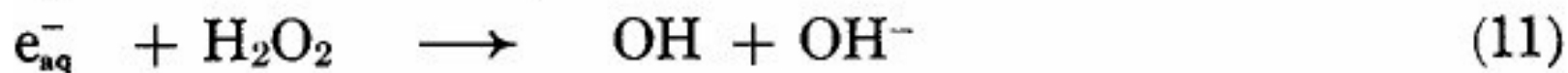
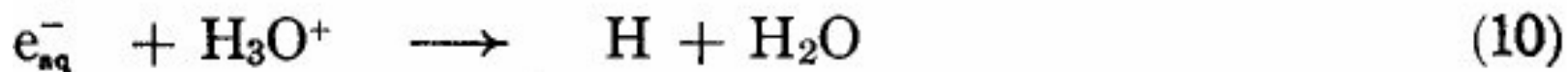
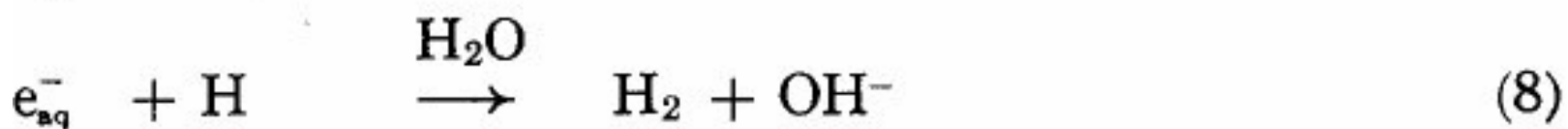
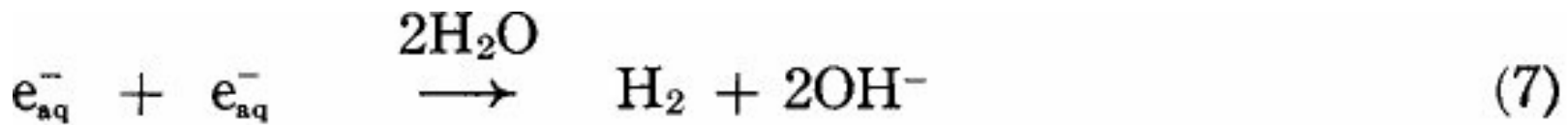

The reactions (7)-(17) start in the places of localized energy deposit, and take place while the reacting species diffuse to the bulk of the solution. The situation at about 1 nanosecond (1×10^{-9} sec) after the passage of radiation can be reliably represented as,

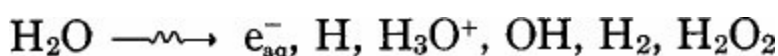

We know very accurately the number of each of these species formed at a given absorbed energy, i.e. their *radiation chemical yields*. Also, we have direct experimental evidence how these yields vary with the radiation type, energy and intensity.

When a solute (S) is present in the irradiated water, then its reactions,

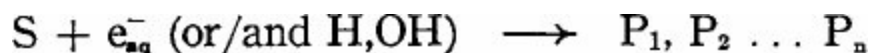

lead to the products (P) formation. Its amount can serve as a measure of absorbed dose if a number of conditions are satisfied.

Conditions for a liquid system to be a chemical dosimeter

Any radiation-induced chemical change in liquids may, in principle, serve as a measure of absorbed dose. In practice, nevertheless, the system chosen must satisfy a number of conditions. Some of the more important are the following:

(a) The amount of chemical change should be proportional to the absorbed dose. In the case that

the relation between the dose absorbed and the chemical change measured is not linear, calculation of the dose must be simple.

(b) A method that is accurate but also simple should be used for determining the amount of chemical change proposed as a measure of absorbed dose.

(c) Chemical dosimeters should be manufactured from commercial substances, without any additional purification, and the dosimetric samples must be handled under normal laboratory conditions.

Some technical remarks

The radiation vessel is an important part of any liquid chemical dosimeter because of the possible effect of its surface on the reaction mechanism. It is important to take into account its size and material of which it is made, as well as the effective volume of dosimetric liquid. Plastic vessels are less convenient often only because of difficulties in cleaning. Special care is needed in working with vessels of stainless steel, which are sometimes indispensable in accelerator irradiations. In general, the following precaution should be taken: if a chemical dosimeter is used under working conditions considerably differing from those under which the yield of its reaction was measured (effective volume, size and material of which irradiation vessel is made) it is necessary to check experimentally whether or not these conditions affect the value of radiation yield used in calculating the dose.

Purification of water is important for aqueous chemical dosimeters: any impurity present competes with reactive species involved in reactions (7)-(17), or with solutes added, and might influence the results obtained. It is often carried out by continuous triple distillation of ordinary distilled water: first from an acid dichromate solution, then from alkaline permanganate and finally without any additive.

In the absorbed dose calculation we have to take into account that any chemical dosimeter measures only the dose absorbed in its effective volume, while for radiation application we need the dose absorbed in the sample treated. Liquid chemical dosimeters are convenient for the dosimetry of water or tissue-equivalent materials since the corrections, if required, involve only a few well established parameters. However, in gamma ray dosimetry a significant correction factor may be involved due to the ratio of absorbed dose build-up factors for the dosimeter system and the sample studied.³ This factor is due to the "softening" of gamma rays as they penetrate the irradiated medium and to the fact that the absorption cross-sections increase appreciably (particularly in higher Z materials) with decreasing photon energy. This difference in absorption characteristics due to the degraded spectra is large in the ceric sulphate dosimeter, where heavy cerium ions give rise to higher absorbed doses at loci where the spectrum is degraded. If, for example, there is a 16 cm layer of dosimetric liquid between the ⁶⁰Co point source and the sample studied, then the dose absorbed in 0.4 M ceric sulphate will be 1.7 times as high as that in water irradiated under the same conditions. This effect is small for Fricke dosimeter (0.2% increase in above conditions) and non-existent for oxalic acid dosimeter. It should be pointed out, however, that with accelerated electron irradiations the spectral degradation problems mentioned above do not occur. There, the corrections for differences in dose absorbed by dosimeter and sample can be based directly on stopping power data for electron energy.

Present Status

Single user license provided by AAMI. Further copying, networking, and distribution prohibited.
Survey of chemical systems, and radiation-induced chemical reaction in liquids, of interest for dosimetry.

In the past forty years, since Hugo Fricke suggested that the oxidation of the ferrous ion induced by radiation could be used as a measure of the radiation dose, dozens of chemical systems and radiation-induced chemical reactions were examined from the point of view of absorbed dose measurements. Many of them were considered for the kilorad-to-megarad range. Table I lists some of these liquid chemical dosimeters. It should be noted that none of them entirely satisfies all the needs of dosimetry in radiation processing. This is not surprising if one takes into account ample possibilities offered by existing irradiation sources and the complexity of phenomena in irradiated liquids.

Table I. — Some Chemical Systems Considered for Dosimetry in Kilorad and Megarad Regions

System	Dose range, rad	Dosimeter solution	Chemical change and its measurement
Ferrous sulfate (Fricke dosimeter)	$1 \times 10^3 - 4 \times 10^4$	Air-saturated 0.4 M H ₂ SO ₄ , 1×10^{-3} M FeSO ₄ 1×10^{-3} M NaCl	Fe ³⁺ formation. Spectrophotometry.
Super-Fricke	$1 \times 10^3 - 2 \times 10^5$	Oxygen saturated, 0.4 M H ₂ SO ₄ 1×10^{-2} FeSO ₄	Fe ³⁺ formation, Spectrophotometry.
Ferrous-cupric	$5 \times 10^4 - 1 \times 10^6$	Oxygen-saturated, 5×10^{-3} M H ₂ SO ₄ , 1×10^{-3} M FeSO ₄ , 1×10^{-2} M CuSO ₄	Fe ³⁺ formation. Spectrophotometry
Ceric sulfate	$1 \times 10^4 - 2 \times 10^7$	Aerated, 0.4 M H ₂ SO ₄ , Ce(SO ₄) ₂ from 2×10^{-4} M, to 5×10^{-2} M.	Reduction of Ce ⁴⁺ . Spectrophotometric measurements of [Ce ⁴⁺] before and after irradiation.
Oxalic acid	$1.4 \times 10^6 - 1 \times 10^8$	Initially aerated solutions of H ₂ C ₂ O ₄ , from 5×10^{-2} M to 0.6 M.	Oxalic acid decomposition. Spectrophotometry or titration.
Sodium formate	$1 \times 10^6 - 8 \times 10^7$	Deaerated H ₂ O, HCOONa from 5×10^{-2} M to 0.3 M	Formate ion decomposition. KMnO ₄ titration.
Benzene	$5 \times 10^3 - 7 \times 10^4$	Aerated H ₂ O, 2×10^{-2} M benzene.	Formation of phenol and phenol-like compounds. Spectrophotometry.
Radiochromic dye cyanides	$10^2 - 10^6$	Solutions in various organic solvents	Dye formation. Spectrophotometry.
Chlorobenzene	$10^5 - 10^7$	Solutions in ethanol with some water present	Titration of HCl formed
Hydrocarbons releasing HCl under the action of radiation	$10 - 10^6$	Aqueous solutions. Various concentrations of: chloroform, trichloroethylene, chloral hydrate.	HCl formation. Colorimetric, measurement of the coloration produced by the reaction of HCl with a suitable indicator.
Optically active hydrocarbons	$10^7 - 10^8$	Aqueous solutions. Various concentrations of glucose, saccharose, maltose.	Decrease in optical activity. Polarimetry.

The aim of the present paper is to consider the status and current tendencies in chemical dosimetry of interest only for radiation processing of medical products. This is why the reader interested in detailed information on other systems is referred to the literature: liquid dosimeters^{2,4,5,6}, and in-pile chemical dosimeters⁷. We will here consider only four systems in more detail: Fricke, the ferrous-cupric, the oxalic acid and the ethanol-chlorobenzene dosimeter. The first three of these systems have previously been written into tentative standard procedures by member of a subcommittee of the American Society for Testing Materials (ASTM) and one of the procedures, that for the Fricke dosimeter, has received final approval as an ASTM standard.

Ferrous sulphate dosimeter

The oxidation of ferrous ions in acidic, aerated, solutions was proposed as a chemical dosimeter already in the early days of radiation chemistry. After forty years, the Fricke dosimeter is still the most widely used chemical dosimeter. Numerous studies, reported in well over 100 articles, have contributed to a better understanding and an efficient use of the radiation-induced oxidation of ferrous ions, but the basic idea and the system used remain the same.

The dosimetric solution is made of 1×10^{-3} M FeSO_4 (or ferro-ammonium sulfate) and 1×10^3 M NaCl in air saturated 0.4 M H_2SO_4 (Ref. 2). The solutions are prepared from A.R. grade chemicals and triply distilled water. If measurements are done only from time to time, it is necessary to prepare a fresh solution before use. If measurements are carried out every day, or very frequently in the course of the same day, then use can be made of a stock solution. This is a 0.1 or 0.01 M FeSO_4 solution in 0.4 M sulfuric acid (in preparing it, ferrous sulfate is dissolved in acid and not in water). It should be kept in normal flasks previously cleaned in the same way as vessels for radiation-chemical experiments. For good stability it is best to keep the stock solution in a refrigerator. In such a way the slow oxidation of ferrous ions by oxygen from air, which is particularly troublesome in measurements at the lower limit of doses or below it, is reduced to a minimum.

The reaction mechanism in aerated solutions, and at low dose rates, can be illustrated by the simplified reaction scheme, in which the products formed in irradiated water (see eqs. 1-17) take part:

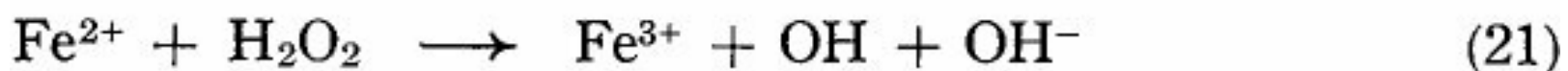
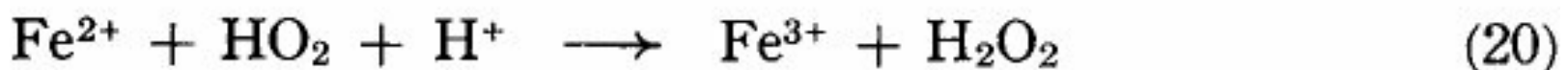
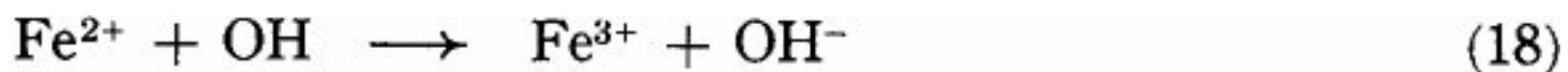

The ferric ions produced by radiation are most suitably measured spectrophotometrically at 3040 Å. The optical density of ferrous ions is practically negligible at this wavelength. The Lambert-Beer law holds up to 10^{-2} M Fe^{3+} and the molar extinction coefficient (ϵ) is $2197 \text{ M}^{-1}\text{cm}^{-1}$ at 25°C; ϵ increases by 0.69% per each degree of increase in temperature. These figures represent the mean values of a number

of measurements performed at different laboratories.

Absorbed dose (D) in rad is calculated by the following general formula:

$$D, \text{ rad} = \frac{N \Delta (\text{OD}) 100}{\epsilon 10^3 G (\text{Fe}^{3+}) f \delta l} \quad (22)$$

where

N = Avogadro's number = 6.022×10^{23} molecules M^{-1}

$\Delta (\text{OD})$ = the difference between the optical densities of irradiated and control samples

ϵ = molar extinction coefficient = $2.197 M^{-1} \text{cm}^{-1}$ at 25°C

f = conversion factor for transition from eV ml^{-1} units into rad = 6.245×10^{13}

δ = density of the dosimeter solution = 1.024 for 0.4M H_2SO_4

l = optical path length (in cm)

$G(\text{Fe}^{3+})$ = radiation-chemical reaction yield under given conditions.

For 0.4 M H_2SO_4 , 1 cm absorption cells and $G(\text{Fe}^{3+}) = 15.6$, equation (22) reduces to

$$D, \text{ rad} = 2.75 \times 10^4 \times \Delta (\text{OD}) \quad (23)$$

assuming that optical density measurements are performed at 25°C . If this is not the case, the above mentioned temperature correction (0.69% per 1°C) should also be taken into account.

At present we know fairly well how the radiation yield of ferric ions, formed under the action of ^{60}Co gamma rays, depends on various experimental conditions. A volume of dosimetric solution 2 ml $< V < 470$ ml was found to have no appreciable effect on the values measured. The vessels used are in most cases made of glass. The concentration of sulfuric acid should be allowed to decrease only down to 0.05M, since in less acid solutions the reproducibility of the values measured is poorer and proportionality between the dose absorbed and the amount of ferric ions produced is no longer linear. Ferrous sulfate concentration in the range from $1 \times 10^{-4}\text{M}$ to $1 \times 10^{-2}\text{M}$ has no effect on the reaction yield measured. The concentration of oxygen in solution in equilibrium with air is sufficient for doses up to 50 krad. Nevertheless, for the sake of good reproducibility it is desirable that irradiations not be carried out before the complete consumption of oxygen, hence a dose of 40 krad is taken as the upper limit. After consumption of oxygen, the reaction yield decreases down to 8 G-units. The effect of temperature on $G(\text{Fe}^{3+})$ is less than 0.1% per 1°C .

The radiation-chemical yield for the Fricke dosimeter has been determined in numerous experiments and Table II gives some of the values recommended for use in equation (22). Ferric yield depends on the type and energy of radiation. As the example of X-rays shows, the value 15.6 which is valid for high energy photons in a very wide energy range, cannot be used for 60 keV X-rays, where $G(\text{Fe}^{3+}) = 13.8$ was determined. Recent data on the ferric yield dependence on photon energy can be found in the literature as well as the $G(\text{Fe}^{3+})$ values for radiations with different LET (Linear Energy Transfer). However, a better knowledge of the yield changes in the transition LET range (between 1 and $10 \text{ keV } \mu\text{m}^{-1}$) is still required.

Table II. — Some $G(\text{Fe}^{3+})$ Values for the Fricke Dosimeter for High Energy Photons*

Radiation	Energy, in Mev	$G(\text{Fe}^{3+})$
Photons	11 – 30	15.7
Photons	5 – 10	15.6
Photons	4	15.5
Photons	2	15.4
^{60}Co gamma rays.	1.25	15.6
^{137}Cs gamma rays	0.66	15.3

*According to ref. 5 and "Radiation Dosimetry: X-Rays and Gamma Rays with Maximum Photon Energies Between 0.6 and 50 MeV", International Commission on Radiation Units and Measurements, ICRU Report 14, Washington, 1969.

One of the limitations in the use of Fricke dosimeter is that it can be applied in the kilorad range only. The upper limit is low for strong radiation sources which often provide dose rates considerably higher than 40 krad sec^{-1} . Such a rapid reaching of the upper limit raises the problem of accurate timing of irradiation and of adequate concentrations of ferrous ions and oxygen. The procedures proposed for shifting the upper limit consist in increasing the concentration of ferrous ions (up to $5 \times 10^{-2}\text{M}$) and ensuring a sufficient amount of oxygen (by bubbling it through solution during irradiation). The radiation yield is the same as under the standard conditions but only up to about 40% of conversion of ferrous ions; the dosage curves are thereafter no more linear. The blank should also be treated in the same way in order to avoid the error due to increased oxidation caused by impurities or oxygen from air. In such cases the measurements (at moderate dose rates) up to doses of the order of 1 Mrad are possible. Similar upper limit can be reached with deaerated solution and $G(\text{Fe}^{3+}) = 8.0$, where the dosage curves are linear up to about 25% of conversion of ferrous ions.

For doses below the lower limit (4 krad), the problem arises of reliable measurements of a small amount of the ferric ions produced, as well as of errors due to the ferrous ion oxidation by agents other than radiation (air-oxygen, impurities). With recent supersensitive spectrophotometers, long absorption cells (10 cm) and carefully prepared fresh dosimeter solutions, the lower limit can be shifted down to 0.1 krad or less.

The ferrous-cupric dosimeter

This system is recommended in the range between 50 krad and 1 Mrad. The reaction used is oxidation of ferrous ions in an aqueous sulfuric acid solution, $5 \times 10^{-3}\text{M}$, containing $1 \times 10^{-3}\text{M}$ FeSO_4 and $1 \times 10^{-4}\text{M}$ CuSO_4 , and saturated with oxygen⁴. Fresh solution must be made every day. The measurement of ferric ions formed and the absorbed dose calculation are as described in the previous section. The equation (22) can be used in calculating the absorbed dose but the value of $G(\text{Fe}^{3+})$ is 0.72. The reproducibility is satisfactory only in well standardized working conditions. It has been shown that the dosage curves are not perfectly linear, especially beyond 600 krad. For a better accuracy a calibration curve must be produced for the working conditions.

Oxalic acid dosimeter

Oxalic acid molecules in aqueous solutions decompose under irradiation to give CO_2 as the main

product. Other compounds are formed in lower yields, after oxygen depletion (dihydroxytartaric and glyoxylic acids, some aldehydes). The process employed for the determination of the absorbed dose (1.4 Mrad-100 Mrad) is the radiolytic decomposition and the dose is derived from the difference in concentrations of oxalic acid before and after irradiation.

The dosimeter solution is prepared from distilled water and commercial A.R. grade $\text{H}_2\text{C}_2\text{O}_4 \cdot 2\text{H}_2\text{O}$.² Appropriate initial concentrations for measurement in different absorbed dose regions can be obtained from Table III. The system is neither photosensitive nor particularly sensitive to impurities, and a stock solution can be used if stored under conditions usual in analytical chemistry. If measurements are carried out only from time to time, it is desirable to prepare fresh solutions. The ampoules are filled with solutions in such a way that a free volume, about $\frac{1}{4}$ of the total ampoule volume, remains over the solution. Dosimeter solutions are initially aerated, oxygen is quickly consumed and not renewed. Irradiated samples are handled under normal laboratory conditions, in the presence of light and air.

For measurements of oxalic acid concentration, both NaOH titration and spectrophotometry with copper-benzidine give satisfactory results. For titration with NaOH, dosimeter solution is diluted with water, and CO_2 is removed by heating at 80-90°C for half an hour. The titrations are carried out with a standard 0.1 N solution in the presence of phenolphthalein (1% solution) as indicator.

Table III. — Initial Concentrations of Oxalic Acid for Measurements in Different Dose Regions.

Dose range, in Mrad	1.4 - 8	2.8 - 16	7 - 40	14 - 80	17 - 100
Concentration of oxalic acid, in M	5×10^{-2}	1×10^{-1}	0.25	0.50	0.60

Spectrophotometric measurements are performed at 2480 Å. The copper-benzidine reagent is made by mixing equal volumes of solutions A and B prepared in the following way. Solution A: 161 mg of recrystallized benzidine hydrochloride is dissolved in 5 ml of 30% acetic acid and diluted with water to 500 ml in a volumetric flask. Solution B: 375 mg of copper acetate is dissolved in 500 ml of distilled water in a volumetric flask. If the capacity of the volumetric flask in which the dosimeter solution is mixed with the reagent is V, then the amount of the reagent A + B to be added is V/5. The molar extinction coefficient is about $2500 \text{ M}^{-1}\text{cm}^{-1}$ and depends on the purity of the chemicals used. It has a negative temperature coefficient, -0.7% per degree centigrade. The optical density is linearly proportional to the oxalic acid concentration in the range 1.4×10^{-5} to 2.5×10^{-4} M.

The decomposition rate of oxalic acid decreases with increasing absorbed dose. It can be represented by an expression for the first-order process, which in a suitable form gives

$$D, \text{ eV/ml} = a C_0 \log C_0/C \quad (24)$$

where C_0 and C is the oxalic acid concentration (molecules ml^{-1}) before and after irradiation, respectively. The proportionality factor $a = 41.5 \text{ eV mole}^{-1}$. It was found that a does not depend on the initial concentration of oxalic acid between 0.05 M and 0.60 M, on dose rates up to $2 \times 10^9 \text{ rad sec}^{-1}$ and on irradiation temperatures up to 80°.

The comparison of a values determined at eight laboratories in Europe (Vinca and Zagreb, Yugoslavia; Risø, Denmark; Rez, Czechoslovakia and USA (Natick, AEC, BNL and Dow Chemical

Co.) shows variations larger than the limits of experimental error. The qualitative explanation might be found if one takes into account the mode of delivering the absorbed doses in above cases and its consequences for the competition reactions involving stable radiolytic products accumulated at larger doses.⁸ For practical purposes this means that a calibration curve might be often preferred for the given working conditions.

Ethanol-Chlorobenzene dosimeter^{9,10}

The radiation-induced process used in dosimetry is the dissociation of chlorobenzene, mainly by dissociative electron capture, yielding hydrochloric acid,



The dosimetric solution is made from chlorobenzene 4%-60% in ethanol that also contains some water (4%). Chlorobenzene is used as a source of chlorine because of its high thermal stability, its resistance to oxidation, and because of the possibility of matching the electron density of the material being studied simply by adjusting the solute concentration in the dosimetric solution. Ethanol acts as an inhibitor of chain reactions and a good solvent for the HCl formed. The role of water is to enhance the solvation of HCl and its radiolytic stability. The dose-range is from 0.1 Mrad to 10 Mrad. The absorbed dose is calculated as

$$D, \text{ rad} = 9.6 \times 10^8 \frac{C}{\delta \times G} \quad (27)$$

where C is measured concentration of HCl in mole·liter⁻¹, δ the density of dosimetric solution (g·cm⁻³) and G respective radiation chemical yield of HCl formation in working conditions.

It should be noted that G(HCl) varies between 4 and 6 and depends on a number of factors such as: chlorobenzene concentration, presence of oxygen, absorbed dose and to some extent also on the dose-rate. Table IV summarizes G(HCl) and δ values for various dosimetric solution. Dose-insensitive values given in Table IV were obtained in the range of 0.1-10 Mrad by partial evacuation of the system before sealing.

Table IV. — Radiation-Chemical Yields of HCl Formation in Ethanol-Chlorobenzene Dosimeter (See equation 27)

Chlorobenzene (vol. %)	G(HCl) ^a	ρ^b (g/cm ³)
4	4.00	0.817
10	5.00	0.835
14	5.36	0.848
18	5.60	0.861
20	5.66	0.867
25	5.80	0.883
30	5.92	0.898

40	6.06	0.929
50	6.10	0.960
60	6.12	0.991

a) To be used for 0.1 Mrad – 10 Mrad dose range.

b) The density of dosimetric solution at 20°C.

Hydrochloric acid content in irradiated solutions is conveniently performed by mercuri-metric titration with diphenylcarbazone as an indicator; the solution of $\text{Hg}(\text{NO}_3)_2$ should be daily standardized.

Current Tendencies

Improvements of known liquid chemical dosimeters

A new variation on the Fricke dosimeter was recently presented in which *the ferric-ion yield is measured by means of electrochemical technique*.¹¹ Dosimeter solution consists of 1mM ferrous sulphate and 1 mM potassium fluoride in aerated triply-distilled water made up to pH 2.7 with H_2SO_4 . The ferric ions formed under radiation build the complex with fluoride ion and the decrease in its concentration is measure for the absorbed dose. The analysis is performed by means of a fluoride ion selective electrode, and the electrochemical potential between it and the reference electrode is read on a pH-meter Since the Fe^{3+} cation complex with F^- is not passed by the lanthanum fluoride crystal membrane at the end of the electrode probe, and since the free F^- concentration diminishes linearly with dose up to about 40 krad, the absorbed dose (1 krad to 40 krad range) can be calculated from readings of linear change in millivoltage. The value for radiation yield of $\text{Fe}^{3+} - \text{F}^-$ complex formation was found to be 13.7, in agreement with $G(\text{Fe}^{3+})$ in Fricke dosimeter observed at pH 2.7.

An interesting technical contribution to the use of *ethanolchlorobenzene* dosimeter was achieved by *oscillometric analysis* of samples irradiated in the dose range from 0.1 Mrad to 60 Mrad¹² For the measurements of conductivity an oscillator in the 1-600 MHz range is used. The sample is placed between the armature of the condenser of a paralld oscillatory circuit, i.e. it is connected as a capacity cell. The calibration curve is made under the same geometrical conditions with solutions containing known Cl^- ion concentrations. This method requires no galvanic contact with the irradiated solution and sealed dosimetric samples (polyethylene containers) can be kept as a reference for a longer time (e.g. for two years).

The change in the optical rotations of aqueous solutions of glucose on irradiation with gamma rays has been recently reconsidered for the multi-megarad region. In one case¹³ 10-20% solute concentrations were used in a rather large dose range, between 5 Mrad and 500 Mrad. The results obtained were found to be independent in the large range of temperature (0-80°C) dose rates ($10-10^4 \text{ rad sec}^{-1}$), and the storage time. In another approach¹⁴ it has been confirmed that the system can be used in glass or metal vessels and is not sensitive to contamination by many common laboratory materials. It has been suggested that the problem due to pressurization of the irradiation cells can be overcome by using loosely stoppered cells. The dosage curves were found to be linear up to a total absorbed dose of at least 250 Mrad, and independent in the studied dose range ($0.065-16 \text{ Mrad hour}^{-1}$).

A new family of liquid dosimeters based on radiation-induced dye production in various radiochromic dye cyanides is now being developed.⁴

Lower limits are tenths of a kilorad, upper limits are hundreds of kilorads. Millimolar solutions of dye are made with various organic solvents. A simple and accurate spectrophotometric measurement of the irradiated solution serves as a measure of absorbed dose. Radiation chemical yields of dyes formed depend strongly on solute concentration and the solvent used. The yields are low, tenths of G-units, but the molar extinction coefficients are very high, about $10^5 \text{ M}^{-1}\text{cm}^{-1}$, and the detection sensitivity is high. Absorption maxima are situated between 5500 Å and 6250 Å. The dosage curves are linear and the dose calculation simple. Hexahydroxyethyl pararosaniline cyanide in organic solvents¹⁵ was demonstrated to be convenient for measurements up to about 100 krad. The gamma-ray response of pararosaniline dye cyanide solutions was investigated with special emphasis to extending the linear response up to about 0.5 Mrad. This has been achieved by using as solvents either aqueous acetic acid or alcohol ethers containing dissolved oxygen or small amount of a weak oxidizing agent. A systematic study¹⁶ has shown that molar extinction coefficient and radiation chemical yield of product formed depend on acidity and temperature. Also, the concentrations of the dye and of the oxidizing agent influence considerably the product yield. Some drawbacks should be mentioned: the photo sensitivity of these systems requires care in handling of the stock and working solutions. Also commercially available dye precursors vary in purity and stability and calibration curve is required for every stock solution.

Future Prospects

Chemical dosimetry with liquids is only a part of a wide area of activities in radiation dosimetry. Its contribution is complementary rather than competitive, and it might be surprising to see presently relatively little activity in this branch of radiation research. It is true that with chemical dosimeters described here we can perform the measurements in the kilorad-to-megarad dose range with reasonable accuracy. However, to achieve this it is necessary that the conditions under which the chemical dosimeter is used and calibrated are as nearly the same as possible. If that is not the case, the results obtained at different processing plants may show deviations considerably larger than experimental error, as we have seen in the case of ferrous-cupric and oxalic acid. This fact points out the basic problem in the large-dose chemical dosimetry: a better understanding of radiation-induced process used as the dose measure.

Numerous studies were performed in connection with the reaction mechanisms of systems considered here. Nevertheless, the quantitative reaction schemes were obtained for the kilorad range only while these systems, with exception of the Fricke dosimeter, are used also in the megarad and multimegarad regions. The amounts of radiolytic products accumulated at large doses are often not negligible, and their contributions to the process used in dosimetry are frequently more important than it is generally assumed. This is why small variations in working conditions might affect the trend of dosage curve by influencing the formation of radiolytic products and, thereby, the secondary reactions. For a good reproducibility we have to be able to control the reaction mechanism, and this can be done only if we understand it reasonably well.

It seems that in the near future considerable work still has to be done in order to develop, for the megarad region, a liquid chemical dosimeter which will be as simple, accurate and reproducible as the Fricke dosimeter in the kilorad range. Possible pathways to achieve this are the following:

— Systematic studies of radiation induced reactions, at large doses, in presently used chemical dosimeters. Particular emphasis should be paid to the radiolytic products formation and their role in the reaction mechanism.

— Search for a system where the large dose reaction mechanism will not differ essentially from the one in the low dose region, i.e. where the radiolytic products are not important for the chemical process because of their low chemical reactivities or/and because they do not significantly accumulate in the solution (gaseous products).

References

1. Mozumder, A. (1969) Charged Particle Tracks and Their Structure. *Advan. Radiat. Chem.* 1, 1.
2. Draganić, I. G. and Draganić, Z. D. (1971) *The Radiation Chemistry of Water*, Academic Press, New York.
3. Brynjolfsson, A. (1968) A Significant Factor in Gamma Ray Dosimetry. *Advan. Chem. Ser.* 81, 550
4. Holm, N. W. and Berry, R. J., eds., (1970) *Manual on Radiation Dosimetry*, Marcel Dekker, Inc., New York.
5. Fricke, H. and Hart, E. Y., (1966) Chemical Dosimetry. In *Radiation Dosimetry* ed. Attix, F. H. and Roesch, W. C. Academic Press, New York, Vol. 2, p. 167.
6. Draganić, I. G. and Gupta, B. L. (1973) Current Tendencies in Chemical Dosimetry. In *Dosimetry in Agriculture, Industry, Biology and Medicine*, International Atomic Energy Agency, Vienna, pp. 351-360.
7. Draganić, I. G., Markovič, V. and Radak, B. (1971) Chemical Dosimetry. In *Determination of Absorbed Dose in Reactors*, International Atomic Energy Agency, Vienna, pp. 197-221.
8. Holm N. W., (1973). On the Relevance of Absorbed Dose Standardization and International Dose Intercomparisons with Respect to the Use of Pulsed Electron accelerators. In *National and International Radiation Dose Intercomparisons*, International Atomic Energy Agency, Vienna, pp. 67-77.
9. Razem, D. and Dvornik, I. (1973) Application of the Ethanol-Chlorobenzene Dosimeter to Electron-Beam and Gamma Radiation Dosimetry: II. Cobalt-60 Gamma Rays. In *Dosimetry in Agriculture, Industry, Biology and Medicine*. International Atomic Energy Agency, Vienna, pp. 405-417.
10. Razem, D. and Dvornik, I. (1973) Application of the Ethanol-Chlorobenzene Dosimeter to Electron-Beam and Gamma-Radiation Dosimetry: III, Tissue-Equivalent Dosimetry, In *Radiation Preservation of Food*, International Atomic Energy Agency, Vienna, pp. 537-547.
11. McLaughlin, W. L. and Bjergbakke, E. (1973) Electrochemical Dosimetry Using Ferric-Fluoride Ion Complex Formation. In “*Dosimetry in Agriculture, Industry Biology and Medicine*, International Atomic Energy Agency, Vienna, pp. 383-395.
12. Foldiak, G., Horvath, Zs. and Stenger, V. (1973). Routine Dosimetry for High-Activity Gamma-Irradiation Facilities. In *Dosimetry in Agriculture, Industry, Biology and Medicine*, International Atomic Energy Agency, Vienna, pp. 367-381.
13. Vainshtok, B. A., Generalova, V. V. and Gurskii, M. N. (1969), Dozimetrija intensivnih potokov ioniziruiushchikh izluchenii, FAN Uzbek. SSR, Tashkent, p. 140.
14. Russel, R. D. (1970), Use of Glucose Solutions in Cobalt-60 Gamma Ray Dosimetry, *Int. J. Appl. Rad. Isot.*, 21, p. 143-146.
15. McLaughlin, W. L., Hussmann, E. K., Eisenlohr, H. H. and Chalkley, L. (1971) A chemical Dosimeter for Monitoring Gamma-Radiation Doses of 1-100 krad *Int. J. Appl. Radiat. Isotopes*, 22, 135-140.
16. McLaughlin, W. L. and Kosanić, M. (1974), The Gamma-Ray Response of Pararosaniline Cyanide Dosimeter Solutions, *Int. J. Appl. Rad. Isot.* (in press) (1973).

Problems of Dosimetry at High Dose Rate

B. D. Michael

Cancer Research Campaign, Gray Laboratory, Mount Vernon Hospital, Northwood, Middlesex, HA6 2RN, England.

Abstract: *Under high intensity irradiation the response of many dosimetric systems changes from their response at the relatively low dose rates often used for calibration. These effects and their causes are discussed and compared in ionization, liquid chemical and solid state dosimetric systems. Physical effects of space charge build up and radiative heating are also considered. The discontinuous nature of repetitive pulsed and scanned radiation beams is described. The conditions of a high dose rate irradiation cannot be defined simply by a value for the dose rate. The significant quantities are, in the case of a continuous radiation beam, the total dose and the exposure time; in the case of a discontinuous beam other factors must also be considered.*

Introduction

The development of radiation sources for processing and research has tended towards the production of high intensity beams. Direct current electron beams with powers of the order 10^5 watts and pulsed electron beams at up to 10^{10} watts are now generally available. The intention behind these developments has been to irradiate material to high doses in short exposure times, thereby achieving increased processing speed or other technological benefits. Radiation dosimetry in such intense fields presents two sorts of problem; (a) is the dosimeter reading independent of the dose rate and (b) is the dosimeter response characteristic accurately known at the high dose levels that must often be measured? Such information is not always available for the various dosimetric systems because much of the development work has been carried out at low dose rates, for example, using cobalt-60 gamma rays. The present paper is principally concerned with effects of intense irradiation upon dosimeter response. Throughout, the discussion relates only to low LET radiation, i.e. electrons, gamma and X-rays.

What is high dose rate?

Dose rate is defined as the instantaneous rate of deposition of absorbed energy from a radiation beam at a specified point or region within an irradiated material. It is conveniently measured in units of rads per second, minute or hour, or in watts per kilogram. However, from a microdosimetric point of view the quantized distribution of energy absorption along the track of the ionizing particle in discrete clusters, or spurs of ionization and excitation must also be considered¹. Typically, in low atomic number material of unit density irradiated with 1 MeV electrons, or with gamma rays, the rate of deposition of energy within these regions is greater than 10^{20} rad/sec. This is the rate at which energy is deposited *microscopically* by low LET radiation, even at the lowest beam intensities, and is much greater than the highest *average* dose rates than can be generated.

Clearly, all high dose rate effects that are observed, even using the most intense radiation beams

available, are due to interactions between products formed in the tracks of separate ionizing particles. Lifetime, diffusion, reactivity and concentration of the interacting species are the significant factors involved in dose rate effects. It is therefore important to specify in any high dose rate effect study the *total dose delivered* and, either the *exposure time*, or the *dose rate*. A value for dose rate alone is not sufficient to define the conditions. The term "high dose rate effect" has arisen in connection with effects that can only be observed at high dose rates, however many such effects occur simply when a high dose is given within less than a certain exposure time, and are not really the result of high dose rate *per se*.

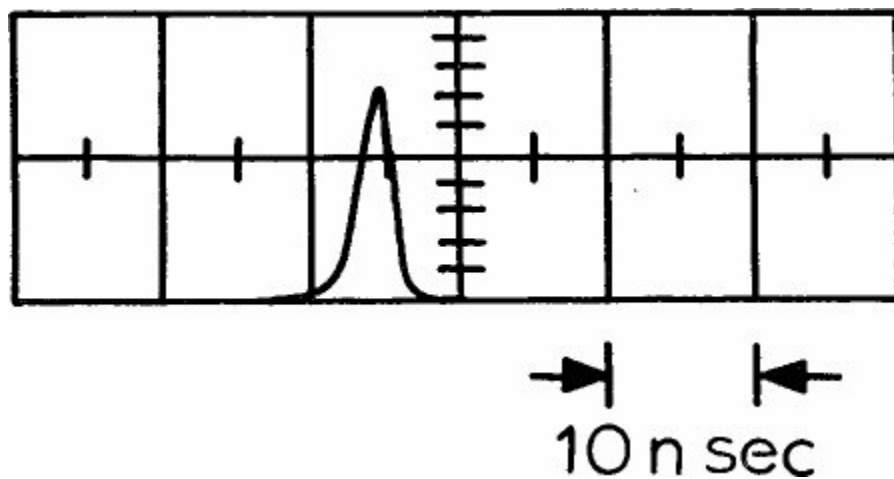

Figure 1. Output pulse from Febetron 706 electron pulse generator. Peak dose rate is approximately 10^{15} rad/sec.

Where the dose rate varies during the exposure it is usually necessary to specify the dose rate as a function of time. Some commonly occurring profiles are shown in Figures 1-3. Figure 1 shows the dose rate during a pulse of electrons from a Febetron generator (Hewlett-Packard, McMinville Division). The maximum dose rate of 10^{15} rad/sec and the 3 nanoseconds FWHM (full width at half maximum intensity) characterize this pulse, which is one of the most intense beams generally available. Although pulses of this intensity are not used for radiation processing they have numerous applications in research, including the testing of dosimeters for dose rate dependence.

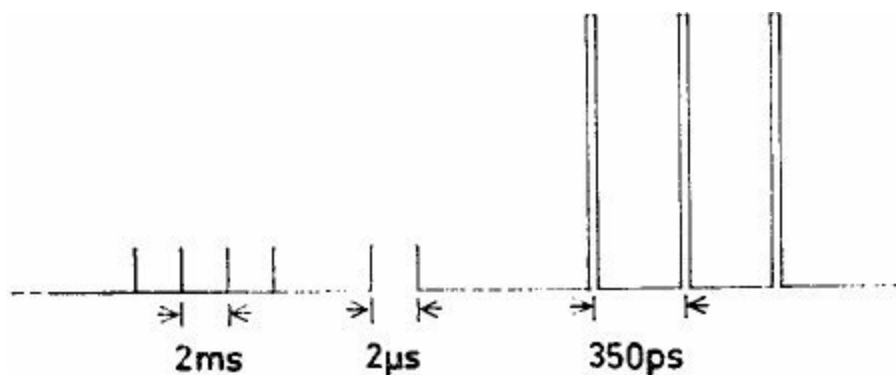

Figure 2. Repetitive pulsed structure of beam from electron linear accelerator, showing also the microwave fine structure pulses.

Figure 2 shows a typical dose rate versus time profile from a small linear accelerator. A one second exposure to 500 pulses from such a beam to a total dose of 1 Mrad will give an overall average dose rate of 10^6 rad/sec, an average dose rate during each 2 microsecond pulse of 10^9 rad/sec, and a peak dose rate during each of the microwave fine structure subpulses of about 10^{10} rad/sec. Radiation of this kind

is used both for processing and for research and dosimetry purposes and clearly any discussion of a dose rate effect cannot be made without reference to the highly discontinuous nature of this beam. An interrupted beam is, of course, produced by any particle accelerator in which the operation is based on repetitive pulsing or where a high frequency accelerating field is used.

Figure 3 shows the dose rate characteristics of one type of electron beam used for sterilization. Here, in curve (b), the instantaneous dose rate at a point on a conveyor belt passing under a swept D.C. electron beam is shown. The point chosen lies close to the edge of the sweep. The belt is passing at right angles to the direction of the beam sweep. The sweep wave form is a symmetrical 200 Hertz sawtooth. Also shown (curve (a)) is the mean dose rate averaged over several sweeps as the point passes along the conveyor. Again the dose rate is discontinuous and no single value can define it.

Numerous other examples exist of discontinuity of the radiation beams used both for the calibration of dosimeters and for radiation processing. With such beams neither the mean nor the peak value necessarily represents an effective dose rate. Detailed information on the response of a dosimeter under high dose and high dose rate conditions is needed before it can be confidently-applied with such beams.

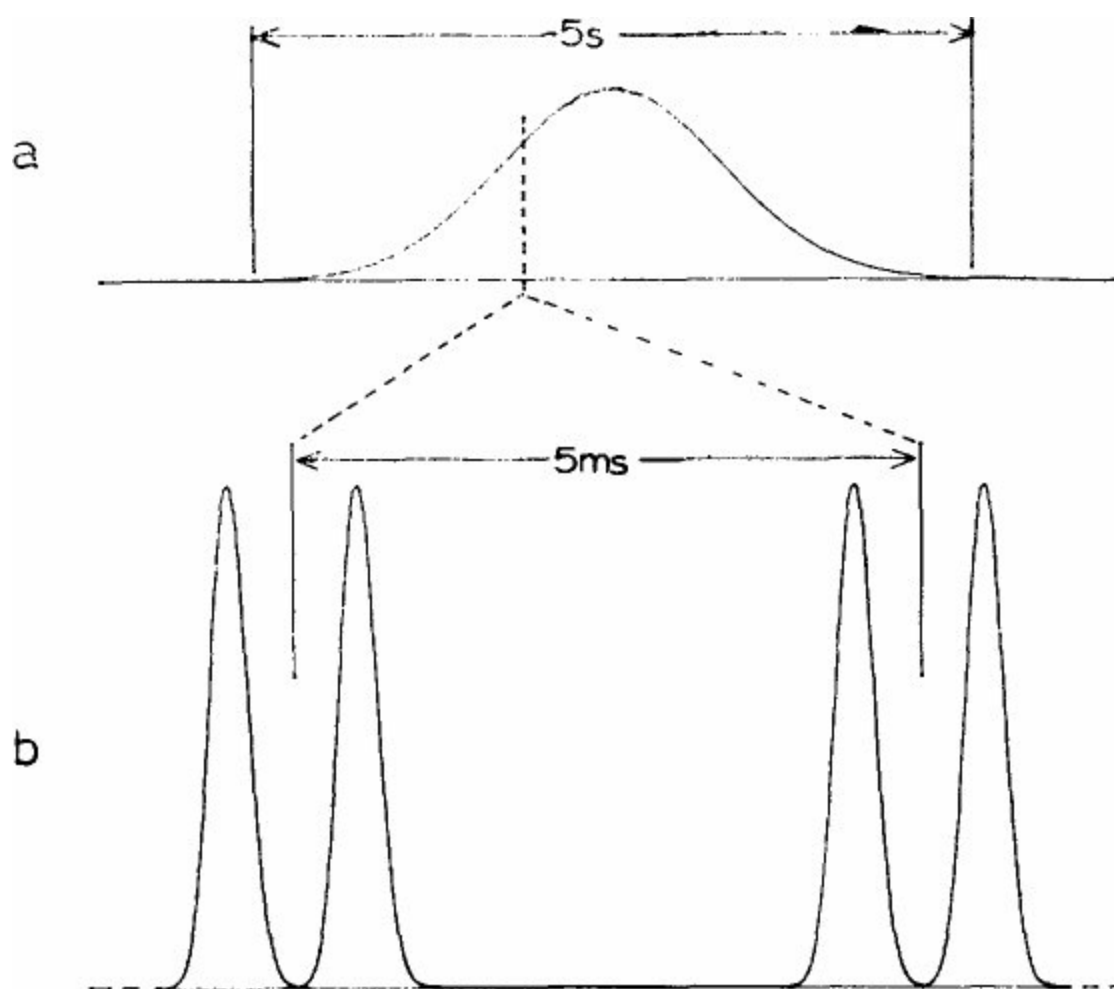

Figure 3. (a) Dose rate of point on a conveyor passing through scanned D.C. electron beam (dose rate averaged over several scans). (b) Instantaneous dose rate during one scan (scan is 200 Hz symmetrical sawtooth).

Effects Occurring At High Dose Rates In Irradiated Materials

Space Charge Effects

Single user license provided by AAMJ. Further copying, networking, and distribution prohibited.

If the dosimeter material is a good electrical insulator, electrons which enter and are stopped within

the material produce a negative space charge. Even at doses of 1 Mrad or less this charge can readily produce an electric field intensity of 1 MV/cm within the dosimeter. This is sufficient to alter the process of energy deposition severely.

Incoming electrons can lose a large fraction of their energy by electrostatic repulsion when travelling against the space charge field, so reducing their range. Appreciable range reduction has been observed in plastics such as Perspex™ and polyethylene^{2,3,4} and this is illustrated in Figure 4. An extreme case, the re-ejection of electrons by a space charge field in pulse irradiated benzene, has been reported⁵.

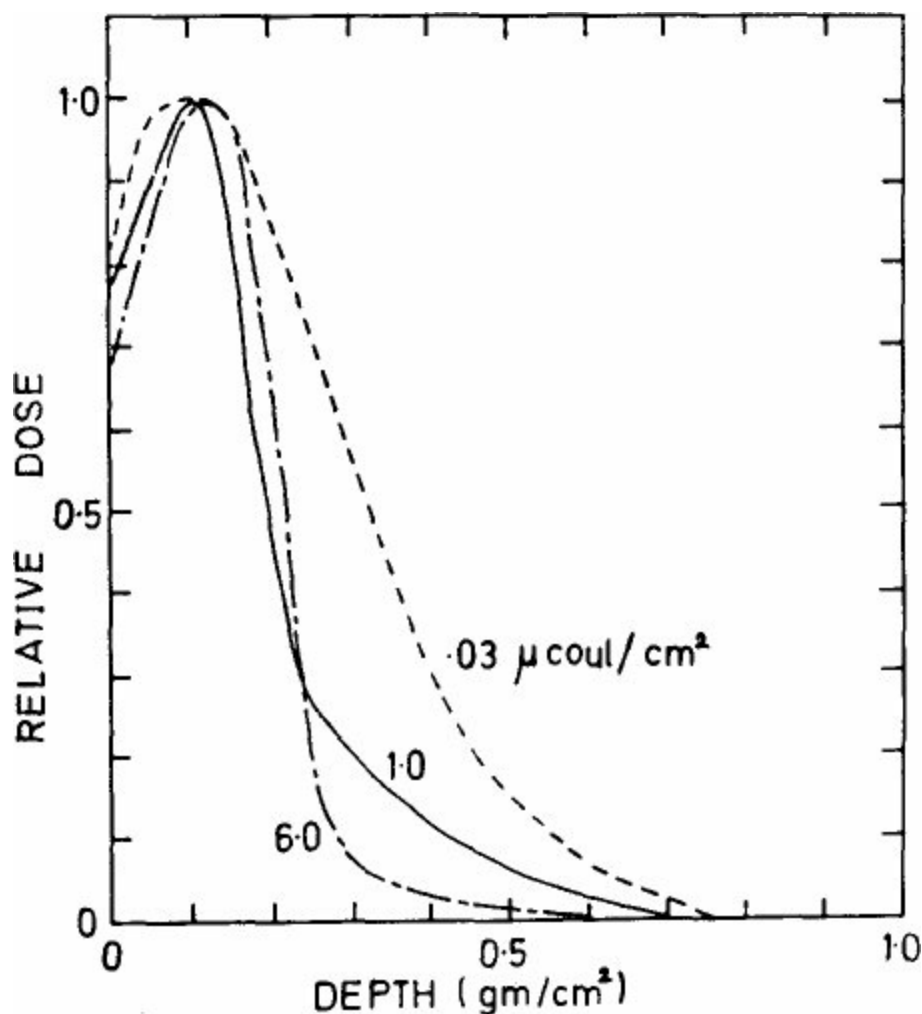

Figure 4. Range reduction due to space charge in plastic dosimeter material irradiated with 1.35 MeV electrons. (Data taken from Ref. 3).

Eventually the space charge leaks away either due to the intrinsic or the radiation-induced conductivity of the material or by electric breakdown. The time scale for discharge by leakage can vary over a wide range, and depends upon the properties of the material, its shape, and the conditions of irradiation. An analysis of space charge fields, electrostatic energy loss and range reduction has been given by Gross, Dow and Nablo⁴. If the charge leaks away in a time that is short compared with the duration of the radiation exposure then range shortening and electrostatic energy loss effects are likely to be small. To avoid space charge effects it is necessary either to use an electrically conducting dosimeter material (e.g. an aqueous solution) in a conducting holder which is grounded, or to arrange the depth of the dosimeter material so that most of the incident electrons pass through and are stopped beyond it in grounded conducting material. If the material is in the form of a stack of thin layers then surface conductivity is sufficient to remove the space charge.

A further possible effect of space charge is that the intense electric field produced may modify the

yields of radiolytic products, for example, by interfering with ion recombination, so altering the radiation response of the dosimeter material. This is particularly likely in dosimeters using electrically insulating organic solvents. No information appears to be available on this subject in dosimetric systems, however such a mechanism could contribute to high dose rate effects and to any observed differences between the responses to charged and uncharged particle beams.

Radiation Induced Temperature Rise

When the dose is delivered in a time that is short compared with the cooling time constant of the material the temperature rise may be appreciable and this will affect the dosimeter response if its sensitivity is temperature dependent. The temperature rise is approximately $\frac{2.2}{\text{sp. ht. of material}}$ degrees C per Mrad.

Ionization Dosimetry

Measurement of the charge liberated within an ionization chamber is one of the longest established and mechanistically best understood methods of dosimetry⁶. It is an absolute method, and standards and calibration techniques are well laid down.

In use it has several important practical advantages. It can be used simultaneously as a dosimeter and as a dose monitor, which is particularly useful where dose rate is an important quantity to consider. Direct readout of accumulated dose and instantaneous dose rate are available continuously during irradiation. Although it is less suited to high dose and high dose rate operation than many other systems, ionization dosimetry has the singular advantage that any deviation of response from low dose and low dose rate performance can be measured and corrected for in use, without recourse to an elaborate test set up.

The total yield of ions produced within the active mass of gas in the chamber is proportional to the dose absorbed by the gas. In practice it is not possible to collect all this yield because of neutralization by recombination. This occurs in two distinct ways. *Initial recombination* takes place within the track of each ionizing particle and is therefore dose and dose rate independent; with low LET radiation the loss of free ion yield due to this process is usually < 1%. *General recombination* which occurs between ions produced in separate tracks is, of course, dose and dose rate dependent, and sets an upper limit to the intensities that can usefully be measured. As the intensity of the beam is increased the collection efficiency drops.

The theory and practice of loss due to general recombination are well formulated⁶.

(a) *Continuous Irradiation*. Here the steady state equilibrium between the continuous production of ions and their eventual neutralization either by recombination (not measured) or by collection (measured) has been analysed. In a plane parallel ionization chamber the fraction of charge lost (i.e. not

measured) due to recombination approximates to $\frac{1}{6} \frac{m^2 d^4 q}{V^2}$ where m is a constant which defines the effects of ion mobilities, general recombination rate and charge and is characteristic of the gas at a given temperature and pressure, d is the plate separation in cm, q is the ionization rate in e.s.u. cm⁻³ sec⁻¹ and V is the voltage between the plates. This expression is quite accurate for recombination losses

below 10%.

(b) *Pulsed Irradiation*. When the duration of radiation exposure is very short compared with the transit time of ions across the chamber then equilibrium between charge production and neutralization does not occur and a different solution applies. Here the fraction of charge lost due to general recombination is, for 10% or less recombination loss, approximately $\frac{1}{2} \frac{\mu r d^2}{V}$ where μ is a constant representing the ion recombination rate, charge and mobilities, and r is the total charge density liberated per pulse in e.s.u. cm^{-3} . The recombination loss is dependent on the dose per pulse and is independent of the instantaneous dose rate during the pulse.

In air at N.T.P. the clearing time for ions is approximately $\frac{d^2}{1.5V}$ and the continuous and pulsed cases apply only for exposure times which are respectively either much longer or much shorter than this value. Recombination losses in these two situations can be measured by varying V and plotting the corresponding measured values of collected ion current or charge against $\frac{1}{V^2}$ or $\frac{1}{V}$ respectively, and by extrapolation obtaining the full current or charge that would be collected at infinite voltage (i.e. $\frac{1}{V}$ or $\frac{1}{V^2}$ equal to zero).

The above solution for pulsed irradiation applies to repetitive pulsing when the interpulse interval is less than the clearing time for ions.

The most efficient geometry for a high dose rate ionization chamber is plane parallel with careful attention to field uniformity; cylindrical and spherical geometry are in general less efficient⁶.

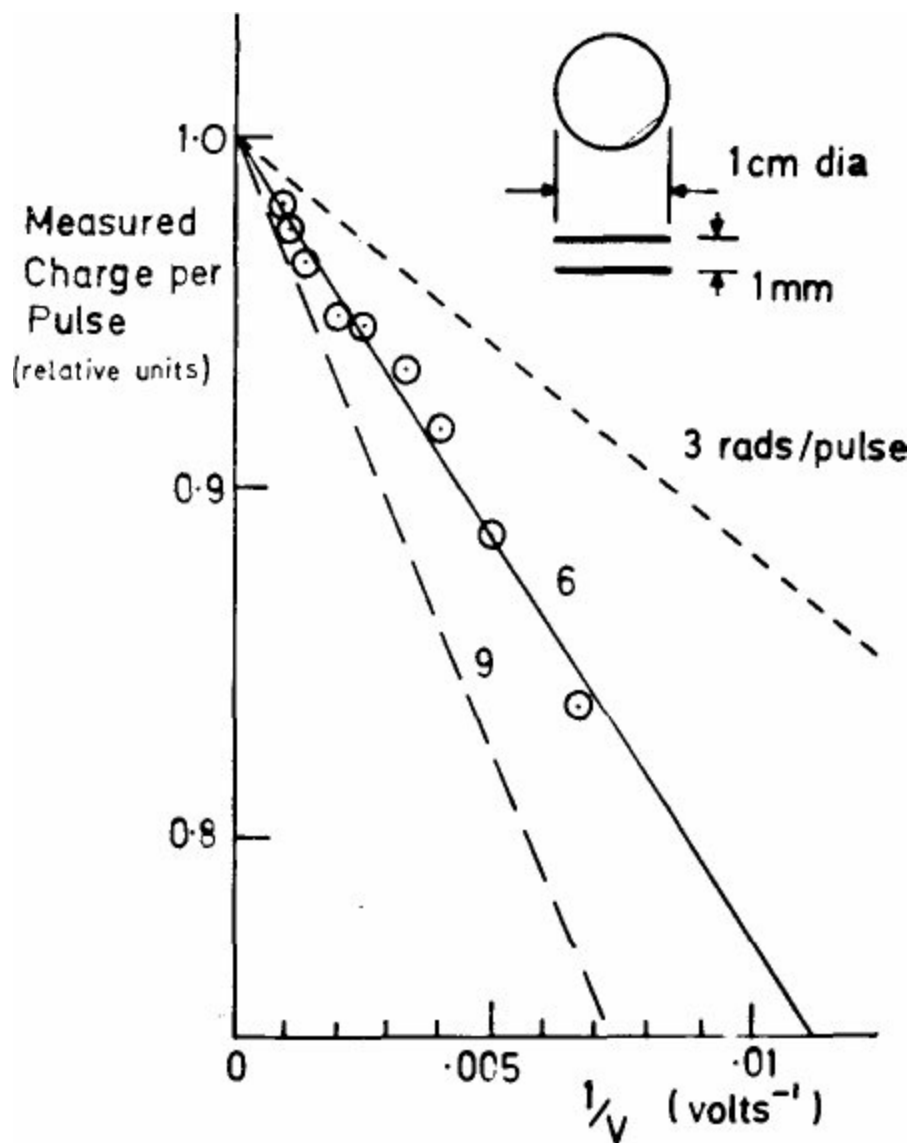

Figure 5. Saturation characteristics of plane-parallel ionization chamber (dimensions shown inset) irradiated with 2 microsecond electron pulses.

The saturation characteristic for an air filled plane parallel chamber under pulsed irradiation is shown in Figure 5. A chamber of this design will operate under continuous irradiation at 10^6 rad/sec with only 2% recombination loss.

Chemical Dosimetry

Many chemical dosimeters employ dilute solutions. Nearly all of the radiative energy absorption is by the solvent molecules to form radicals, \dot{R} , which then diffuse to and react with the solute molecules, S, to form a product, P,



where k_1 is the rate constant for the reaction ($\text{litre mol}^{-1} \text{sec}^{-1}$). If P is chemically stable its increase of concentration is a measure of the dose absorbed. If it is unstable, P reacts to give a further stable product which is measured.

When irradiated to a high dose at high dose rate the yield of product per unit of absorbed dose usually decreases. This is because radical scavenging by reaction (1) is insufficiently fast to prevent the build up of an appreciable concentration of radicals and radical-radical reactions occur which do not produce P,



The apparent yield of P may also be reduced by back reactions of the type $\dot{R} + P$.

Usually reactions (1) and (2) are diffusion controlled, with rates of about 10^{10} litre mol⁻¹sec⁻¹. With pulsed irradiation, the proportion of \dot{R} lost by reaction (2) is approximately $\frac{k_2 R_0}{k_1 S}$, where S is the solute concentration and R_0 is the initial concentration of radicals produced during the pulse, both in mol litre⁻¹; this approximation is valid only if the pulse duration is much less than $\frac{1}{k_1 S}$ and if the fraction of the radicals lost by reaction (2) is small, say less than 10 per cent.

Chemical dosimeter solutions are only suitable for high dose and high dose rate applications when (a) the solute concentrations are high enough to ensure rapid scavenging of primary radicals, (b) the solute depletion due to reaction does not prevent condition (a), (c) all reactions leading to the formation of stable products are fast and the intermediates short lived and (d) the rates of back reactions between radical intermediates and the stable end product are slow or zero.

The use of chemical dosimeters under pulsed conditions has been the subject of a recent review⁷.

Ferrous Sulphate

The Fricke dosimeter (10^{-3} M FeSO₄, 0.8 N H₂SO₄ in air saturated water) shows an appreciable decrease in the yield of Fe⁺⁺⁺ when irradiated with microsecond electron pulses at doses above 1 krad^{8,9,10,11}. The modified, or "super", Fricke dosimeter (10^{-2} M FeSO₄, 0.8 N H₂SO₄ in O₂ saturated water) shows similar effects above about 10 krad per microsecond pulse^{9,10,11}.

A thorough analysis of the kinetics of 18 reactions involved in the standard and modified Fricke dosimeters has been made which enables the behaviour to be predicted under any conditions of dose or dose rate^{10,11}. The principal effect of intense irradiation is a reduction in the proportion of hydrogen atoms scavenged by the reaction H + O₂ due to the high radical concentrations favouring the radical-radical reactions H + H, H + OH and H + HO₂.

Although the modified Fricke system has been superseded by other chemical dosimeters less affected by high radiation intensities, it is still the best understood mechanistically. Its behaviour in single and repetitively pulsed beams as well as under continuous or fluctuating irradiation intensities can be accurately predicted.

The addition of chloride ion to reduce the effects of impurities reduces the sensitivity of the Fricke dosimeter at high intensities.

This is suitable for use at doses ranging from 4×10^4 to 10^8 rads. The radiolytic conversion of ceric ions to cerous ions is measured. The effect of high dose rate is found to be an increase in the cerous ion yield and this becomes appreciable with microsecond pulsed irradiation when the dose rate exceeds about 10^8 rads/sec, (100 rads per 1.1 microsecond pulse)⁸. The ceric sulphate dosimeter is therefore much less suited to high dose rate applications than the standard or modified Fricke systems.

Ferrous Sulphate-Cupric Sulphate Dosimeter

This system is also suitable for the measurement of doses up to 10^8 rads. With 10^{-3} M FeSO₄, 10^{-2} M CuSO₄, 5×10^{-3} M H₂SO₄ deaerated solution there is no dose rate dependence at up to 500 rads per 1.1 microsecond pulse¹². By increasing the Cu⁺⁺ concentration (10^{-3} M FeSO₄, 10^{-1} M CuSO₄, 5×10^{-3} M H₂SO₄ and 240μ M O₂) the dose rate dependence was improved showing little effect at up to 64 kilorad per 2 microsecond pulse (3.2×10^{10} rad/sec) using repetitive electron pulsing to a total dose of about 150 kilorad¹³. This performance is comparable with the modified Fricke dosimeter.

Oxalic Acid Dosimeter

Also suitable for use at high doses (up to 30 Mrad) this system shows little effect of high dose rate¹⁴. Using 200 mM oxalic acid repetitively pulsed to about 25% decomposition (about 10 Mrad) the response was found to be independent of dose rate at up to 2×10^{10} rad/sec during each microsecond pulse. The dosimeter response decreases at high dose rate. Lower concentrations of oxalic acid show a greater dose rate dependence.

Solid State Dosimeters

Many of the high dose and high dose rate limitations of ionization and of chemical dosimeters result, as has been shown, from ion recombination in gases and radical-radical reactions in liquids respectively. These processes are dose and dose rate dependent because they involve reaction between radiation products formed in separate tracks of the ionizing particles. Thus track spacing (i.e. dose) is important, as are also diffusion rate and lifetime of the interacting products. In solids, for example, polymers and crystalline materials, diffusion is extremely slow compared with that in fluids. Interactions between products formed in separate tracks are much slower or do not occur because the formation of stable products by alternative reactions not requiring diffusion have time to take place, for example, unimolecular rearrangement or charge trapping. Solid state dosimeter systems would therefore be expected to be much less dependent in their response upon radiation intensity than the dosimeters using gas or liquid material and this is generally found to be true.

Some recent data¹⁵ on the behaviour of several polymer and dye/polymer dosimeters at dose rates up to 10^{10} rad/sec are given elsewhere in these proceedings¹⁶.

Thermoluminescence Dosimetry

The response of materials used for thermoluminescence dosimetry shows considerable dose dependence¹⁷. The commonly used phosphors CaSO₄, LiF and CaF₂:Mn saturate in their dose

responses at about 10^4 , 10^5 and 10^6 rads, respectively, and below the saturation dose LiF shows supralinearly. The response of LiF is dose rate independent up to at least 2×10^{11} rad/sec and 4500 rads per pulse¹⁸.

Perspex™ Dosimetry

Clear Perspex™, now known as Perspex™ HX, develops a radiation induced u.v. optical absorption proportional to absorbed dose up to about 2 Mrad (ref. 19, 20). No significant dose rate effect has been found under pulsed irradiation from a linear accelerator at dose rates up to 5×10^5 rad/sec (ref. 20) and it is probable that the response is unaltered up to much higher dose rates. Perspex™ containing red or amber dye additives²¹ shows a change of optical absorption in the visible region upon irradiation and is suitable for dosimetry up to about 5 Mrad. Materials of this type do not appear to show any serious departure from low dose rate response when irradiated to doses of about 1 Mrad at 10^{14} rad/sec (ref. 22).

Dye Films

The development in recent years of dye/polymer mixture dosimeters has been particularly successful. The polymer, containing several percent of a dye derivative, can be made into thin films and these develop an intense colouration which is nearly proportional to absorbed dose up to several Mrads. The response of these materials does not appear to be significantly affected by dose rate up to 10^{15} rad/sec (ref. 23, 24, 25, 26, 27). At lower dose rates ($<10^3$ rad/sec) a dose rate effect due to diffusion of oxygen into the film has been observed²⁴.

Polyethylene

The radiation induced change of unsaturation in polythene can be measured by infra red absorption spectrophotometry and provides a useful dosimeter in the megarad range. The response of this system is unaffected by dose rate up to 10^{15} rad/sec (ref. 28).

Calorimetry

Most of the energy absorbed by a material in a radiation beam is eventually degraded to heat. A small proportion, 5 percent or less, may remain bound as chemical energy, but in many solids such as metals and other crystalline materials virtually all of the absorbed energy is converted to heat. Calorimetric measurement of the energy absorbed from a radiation beam therefore provides a direct determination of the absorbed dose^{5,29,30}. The radiation sensitivity of the calorimeter can be established independently of radiation measurement and calorimetric dosimetry is therefore an absolute method.

Technically, calorimetry is usually easier at high dose rates because any heat loss during the radiation exposure is small. The response of a calorimetric dosimeter is completely independent of dose rate.

Conclusions

A comprehensive range of dosimetric systems is available for use under high dose and high dose rate conditions. Instantaneous dose rate, integrated dose and dose distribution can be measured.

The use of high current impulse generators such as Febetron accelerators has enabled many dosimetry systems to be tested under far more extreme conditions of dose and dose rate than are encountered in radiation processing and sterilization.

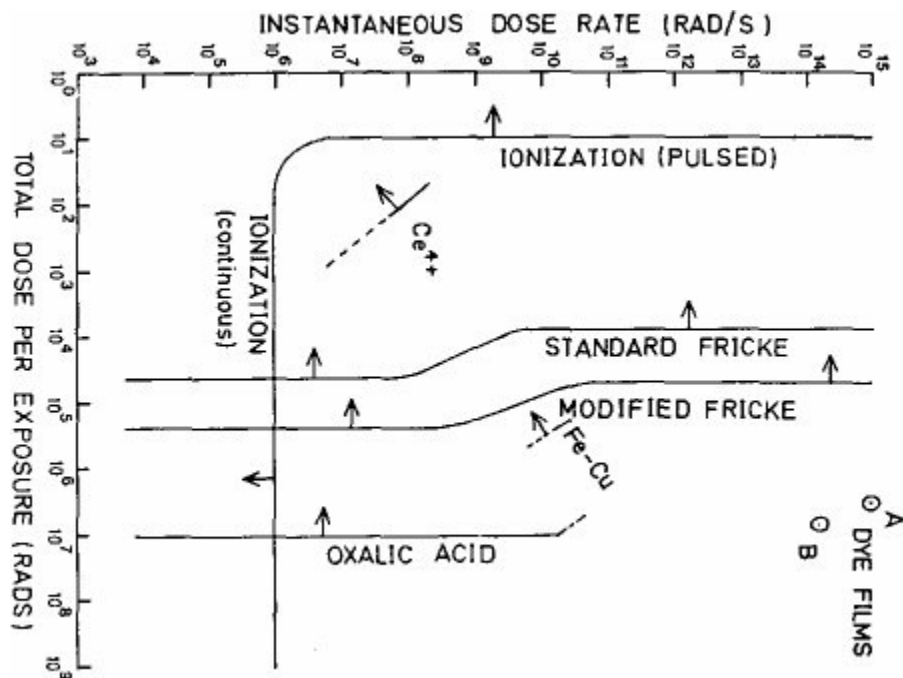

Figure 6. Comparative performance of different dosimetric systems under varying conditions of dose (horizontal axis) and dose rate (vertical axis). Boundaries show upper limits of radiation intensity for 10 percent departure from low dose rate response. Points marked \odot indicate limits of testing so far and do not necessarily represent limitations of dosimeter material. A, Refs. 23-26, B, Ref. 27.

The greatest tolerance of high dose and high dose rate conditions is shown by solid state dosimeters (Figure 6). Polymer and polymer-dye mixtures show very little modification of response even at the highest intensities. Chemical dosimeters in the liquid phase are more susceptible to intensity effects and this is because of the rapid diffusion of and reaction between radicals formed in separate ionizing particle tracks.

Chemical dosimeters suitable for high intensities are either those that employ high solute concentrations (to compete effectively with radical-radical reactions) or those that are based on measurement of a yield of a molecular product formed in the track of the ionizing particle rather than by homogeneous reaction in the bulk of the solvent.

Ionization chambers using gases are not in general suited to high dose rate work, however, with appropriate design, chambers that will operate continuously at 10^6 rad/sec and higher can be readily constructed. This method of dosimetry has the advantage that simultaneous direct read out of dose rate and integrated dose can be obtained.

Where dose rate effects are important, careful consideration must be given to the discontinuous nature of certain radiation beams. The dose rate versus time profile of the beam must be examined and effects due to pulsing and sweeping of the beam must be taken into account. With such beams the decision as to whether a given dosimeter will work correctly independent of any dose rate effects is difficult and may require a full mechanistic understanding of the dosimeter. However, a safe rule is that any dosimeter can be used reliably if it has been shown to operate correctly even if the total dose to be measured were delivered in one exposure at the maximum instantaneous dose rate of the beam.

References

1. Boag, J. W. (1964). Ionization Dosimetry at High Intensity. In *Proc. Int. School Phys., Enrico Fermi, Course XXX, Radiation Dosimetry 78*, Academic Press N.Y. and London, pp. 70-82.
2. Lackner, H., Kohlberg, I. and Nablo, S. V. (1965). Production of Large Electric Fields in Dielectrics by Electron Injection, *J. Appl. Phys.*, **36**, 2064-2065.
3. Harrah, L. A. (1970). Pulsed Electron Beam Energy Deposition Profiles Using Solid Radiation Sensitive Plastics. *I.E.E.E. Trans. Nucl. Sci.*, **17**, 278-283.
4. Gross, B., Dow, J. and Nablo, S. V. (1973). Charge Buildup in Electron-Irradiated Dielectrics. *J. Appl. Phys.*, **44**, 2459-2463.
5. Willis, C., Miller, O. A., Rothwell, A. E. and Boyd, A. W. (1968). The Dosimetry of Very-High-Intensity Pulsed Electron Sources Used for Radiation Chemistry: Dosimetry for Liquid Samples. *Radiation Research*, **35**, 428-436.
6. Boag, J. W. (1966). Ionization Chambers. In *Radiation Dosimetry*, Vol. II, eds. Attix, F. H. and Roesch, W. C., Academic Press, New York, pp. 1-72.
7. Pikaev, A. K. (1972). Chemical Dosimetry of Pulsed Electronic Radiation. *Russian Chemical Reviews*, **41**, 786-794.
8. Rotblat, J. and Sutton, H. C. (1960). The effects of High Dose Rates of Ionizing Radiations on Solutions of Iron and Ceric Salts. *Proc. Roy. Soc., A*, **255**, 490-508.
9. Thomas, J. K. and Hart, E. J. (1962). The Radiolysis of Aqueous Solutions at High Intensities. *Radiation Research*, **17**, 408-418.
10. Sehested, K., Bjergbakke, E., Rasmussen, O. L. and Fricke, H. (1969). Reactions of H_2O_3 in the Pulse-Irradiated Fe(II)- O_2 System. *J. Chem. Phys.* **51**, 3159-3166.
11. Sehested, K., Bjergbakke, E., Holm, N. and Fricke, H. (1973). The Reaction Mechanism of the Ferrous Sulphate Dosimeter at High Dose Rates. In *Dosimetry in Agriculture, Industry, Biology and Medicine*, IAEA, Vienna, pp. 397-404.
12. Bjergbakke, E. and Sehested, K. (1968). The Ferrous-Cupric Dosimeter. In *Advances in Chemistry Series 81*, Amer. Chem. Soc., pp. 579-584.
13. Feng, P. Y., Brynjolfsson, A., Halliday, J. W. and Jarrett, R. D. (1970). High-Intensity Radiolysis of Aqueous Ferrous Sulphate-Cupric Sulphate-Sulphuric Acid Solutions. *J. Phys. Chem.* **74**, 1221-1227.
14. Holm, N. W. and Sehested, K. (1968). The Oxalic Acid Dosimeter Procedure. In *Advances in Chemistry Series. 81*, Amer. Chem. Soc., pp. 568-578.
15. Bjergbakke, E. and Miller. Danish Atomic Energy Commission, report in preparation.
16. McLaughlin, W. L. (1974). Solid State Effects Dosimeters: A Comparison. This session.
17. Fowler, J. F. and Attix, F. H. (1966). Solid State Integrating Dosimeters. In *Radiation Dosimetry*, Vol. II, eds. Attix, F. H. and Roesch, W. C., Academic Press, New York, pp. 241-290.
18. Tochilin, E. and Goldstein, N. (1966). Dose Rate and Spectral Measurements from Pulsed X-ray Generator. *Health Physics*, **12**, 1705-1713.
19. Boag, J. W., Dolphin, G. W. and Rotblat, J. (1958). Radiation Dosimetry by Transparent Plastics, *Radiation Research*, **9**, 589-610.
20. Berry, R. J. and Marshall, C. H. (1969). Clear Perspex H.X. as a Reference Dosimeter for Electron and Gamma Radiation. *Phys. Med. Biol.*, **14**, 585-596.
21. Whittaker, B. (1970). Red Perspex Dosimetry. In *Manual on Radiation Dosimetry*, eds. Holm, N. W. and Berry, R. J. Marcel Dekker, New York, pp. 363-369.
22. Tallentire, A. Private communication.
23. Hussman, E. K. and McLaughlin, W. L. (1970). Dye Films and Gels for Megarad Dosimetry. In *Radiation Dose and Dose Distribution Measurement in the Megarad Range*, U.K. Panel on Gamma and Electron Irradiation.
24. Harrah, L. A. (1970). Chemical Dosimetry with Doped Poly (halostyrene) Film. *Radiation Research* **41**, 229-246.
25. Chappell, S. E. and Humphreys, J. C. (1972). The Dose-Rate Response of a Dye-Polychlorostyrene Film Dosimeter. *I.E.E.E. Trans. Nucl. Sci.*, **NS-19**, 175-180.
26. Bishop, W. P., Humphreys, K. C. and Randtke, P. T. (1973). Poly (halo) styrene Thin-Film Dosimeters for High Doses. *Rev. Sci. Instrums.*, **44**, 443-452.
27. Snow, E. T. (1973). An Evaluation of Kodak's Experimental "Special Megarads Dosimetry Material". Report SLA-73-0991, Sandia Labs., Albuquerque, New Mexico.
28. Charlesby, A. Private communication.
29. Radak, B. B. and Markovic, V. (1970). Calorimetry. Chap. III in *Manual on Radiation Dosimetry*, eds. Holm, N. W. and Berry, R. J. Marcel Dekker, New York.
30. Radak, B. B., Hjortenber, P. E. and Holm, N. W. (1973). A Calorimeter for Absolute Calibration of Thin-Film Dosimeters in Electron Beams. In *Dosimetry in Agriculture, Industry, Biology and Medicine*. I.A.E.A. Vienna, pp. 311-318.

Dosimetry Techniques for Commissioning a Process

K. H. Chadwick

(Commission of the European Communities) Association Euratom-Ital, Postbus 48, Wageningen, The Netherlands.

Abstract: *The paper discusses the dosimetry measurements which are necessary to establish a radiation process in a continuously operating commercial irradiation plant. The measurements are divided into four steps:*

- the calibration of the dosimetry system, which involves the choice of dosimeter, the standard dosimeter, the calibration facility, the measuring equipment, the reproducibility and the possibility of changes in response in the dosimeter in routine use.*
- the calibration of the facility, which involves an accurate determination of the dose-time relationship for a standard dummy product in the irradiation plant.*
- the characterization of the product which involves the determination of the positions of minimum and maximum, dose in the product, the determination of the time parameter which ensures that most of the product receives the required radiation dose and a consideration of the statistics involved in ensuring that the product is properly irradiated.*
- the process and inventory control procedures which are necessary to check that the product continues to receive the required radiation dose and that it is irradiated but not double irradiated.*

It is concluded that the use of a good, reliable well calibrated dosimetry system is essential for the commissioning of an irradiation process as the dosimeter is involved in each important step of the commissioning procedure. It is suggested that further thought be given to the problem concerning the choice of the level of statistical confidence and the probability of failure to achieve the effective dose for the process, and that these levels could probably be agreed upon internationally.

Introduction

Every irradiation plant operator has the responsibility to ensure that a process irradiation is carried out correctly. In the case of the sterilization of medical products this means that the operator must ensure that all the product receives at least the effective radiation dose necessary, and defined by an approving government authority, to achieve the sterilization effect required. This simple statement conceals far more than is at first apparent. Firstly, it implies that radiation dosimetry will be carried out, which in itself involves a working knowledge of the field. Secondly, it implies the measurement of dose distribution or a knowledge of the position of the minimum dose in a product. Thirdly, it should be noted that in fact the operator can never be perfectly sure that all the product has received a certain radiation dose, but can only give a statement of statistical confidence.

The commissioning of a process involves the gathering of the information necessary to make the statement of statistical confidence and can be divided up into four separate steps, 1) Calibration of the dosimeter system, 2) Calibration of the facility, 3) Characterization of the product, 4) Process and Inventory control. The measurements necessary for these four steps are discussed below with special reference to a typical gamma irradiation facility although the measurements can be referred in principle to any irradiation facility.

Calibration of the dosimeter system

Choice of System

The first step in the calibration of a dosimeter system is the choice of the system. Several criteria can be listed which define the usefulness of a dosimeter^{1,2}. For instance, it should have a unique stable response over the dose range used, be reproducible, even in different environments, be independent of dose rate in the range used, be product equivalent, energy independent, be well developed with a proven uniform procedure, it should be cheap, easy to handle and read out, and have a stable read out system. Several dosimetry systems have already been reviewed in these proceedings^{3,4} which will satisfy very many, if not all of these requirements and the final choice will often depend on other factors than those mentioned. However, a plant operator will not want to spend years of development on a dosimetry system and so the availability of a system which is well developed, has a standard, routine, well defined procedure and which is easy to use, will influence the choice. In such a system it will be known which other criteria are not satisfied by the dosimeter and how critical their failings are.

Standard Dosimeter

The dosimeter system now chosen must be calibrated against a standard dosimeter. The Fricke ferrous sulphate dosimeter is the obvious choice for the standard although it can be termed only a secondary standard. It is a well calibrated system which can be used with little difficulty with good accuracy and there are standard procedures for its use^{2,5}. It has only one major disadvantage which is that the dose range is limited to 4-40 krad which means that it should be used to determine the radiation dose rate in a calibration position in which the routine dosimeter system will be calibrated.

Calibration Position

The calibration position can be any well defined position in the irradiation plant or in a separate special facility, where the standard dosimeter and the routine dosimeter can be irradiated under identical conditions. The dose rate in the calibration position should be such that an accurate measurement is possible with the standard dosimeter and that the dose range to be covered by the routine dosimeter can be easily achieved by increasing time exposures. Apart from the normal problems of electronic equilibrium and energy response one or two other points should be kept in mind. In a large radiation facility the dose delivered to the Fricke standard dosimeter by the raising and lowering of the source alone can often contribute a non-negligible portion of the total dose to the Fricke and this dose contribution should be determined and accounted for in the determination of the actual dose rate in the calibration position. This can easily be done by making two measurements with the Fricke at different times, measured from the moment the source is fully up to the moment it starts to descend. If D^1 is the dose rate, D_s the dose given by raising and lowering the source and t and $2t$ are the two exposures, then exposure 1 gives a dose $D_1 = D^1 t + D_s$ to the Fricke; exposure 2 gives $D_2 = 2D^1 t + D_s$, and both D^1 and D_s can be determined.

A second problem is how reproducible and absolute is the calibration position. The following experience serves to illustrate the point. We were measuring in a large Co^{60} facility at a reasonable distance from the source plaque and had good reproducibility over several months where we were able

to measure the decay of the cobalt quite accurately. At a certain moment some measurements indicated that the cobalt had decayed very quickly and we wondered whether we had lost some activity. The effect was eventually very simply explained because the source rods had moved from one side of the source frame to the other and the peak of the dose distribution had moved from the centre of the calibration position out to the side (Figure 1). One should be aware that even in the best calibration facility unexpected changes can occur.

Measuring Equipment

The strength of a chain is determined by the weakest link. One link in the chain often forgotten or neglected in dose calibration is the calibration or control of the measuring equipment. The Fricke measurement involves a spectrophotometer, as do several other dosimeter systems. The measurement of optical density should take place at a defined wavelength so it is necessary to check the wavelength calibration of the instrument⁶. This can be done using a low pressure mercury lamp or using special filters⁶. The optical density scale should also be checked using special solutions^{6,7}. In order to illustrate the differences which can occur between read out instruments, Figure 2 shows the calibration curve for HX Perspex™ dosimeters measured on four different spectrophotometers. The same Perspex™ samples were measured on all the spectrophotometers but one gave a curve which was significantly different from the others. It is essential to good dosimetry to ensure that the measuring equipment, whatever it is, is in good working order.

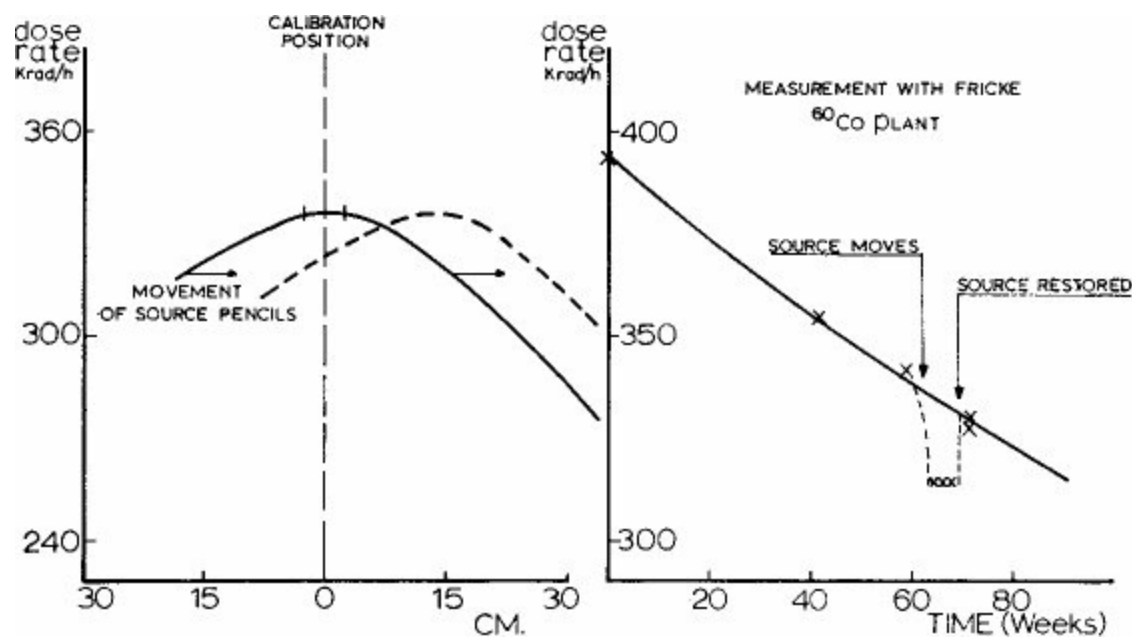

Figure 1. The effect of the movement of source pencils within the source frame on the dose rate at a calibration position in an industrial facility.

Calibration Measurement

In the calibration of the routine dosimeter system using the calibrated dose rate position and calibrated equipment it is necessary to have sufficient dose points in the dose range required to be able to determine the shape of the dose response curve. As a general rule I would be inclined to assume that the response would not be linear, especially at doses in the megarad range where a form of saturation is often occurring. This problem is illustrated in Figure 3. One other piece of information which can be

obtained from the calibration is the reproducibility of the system in the dose range which is required. If, for example, a measurement has been made at some dose D using m dosimeters, then the reproducibility could be expressed as the standard error between the dosimeters ($S_D = \sqrt{\Sigma (D - \bar{D})^2 / m - 1}$) which serves as an estimation of the standard deviation σ_D . The importance of this piece of information will become apparent later.

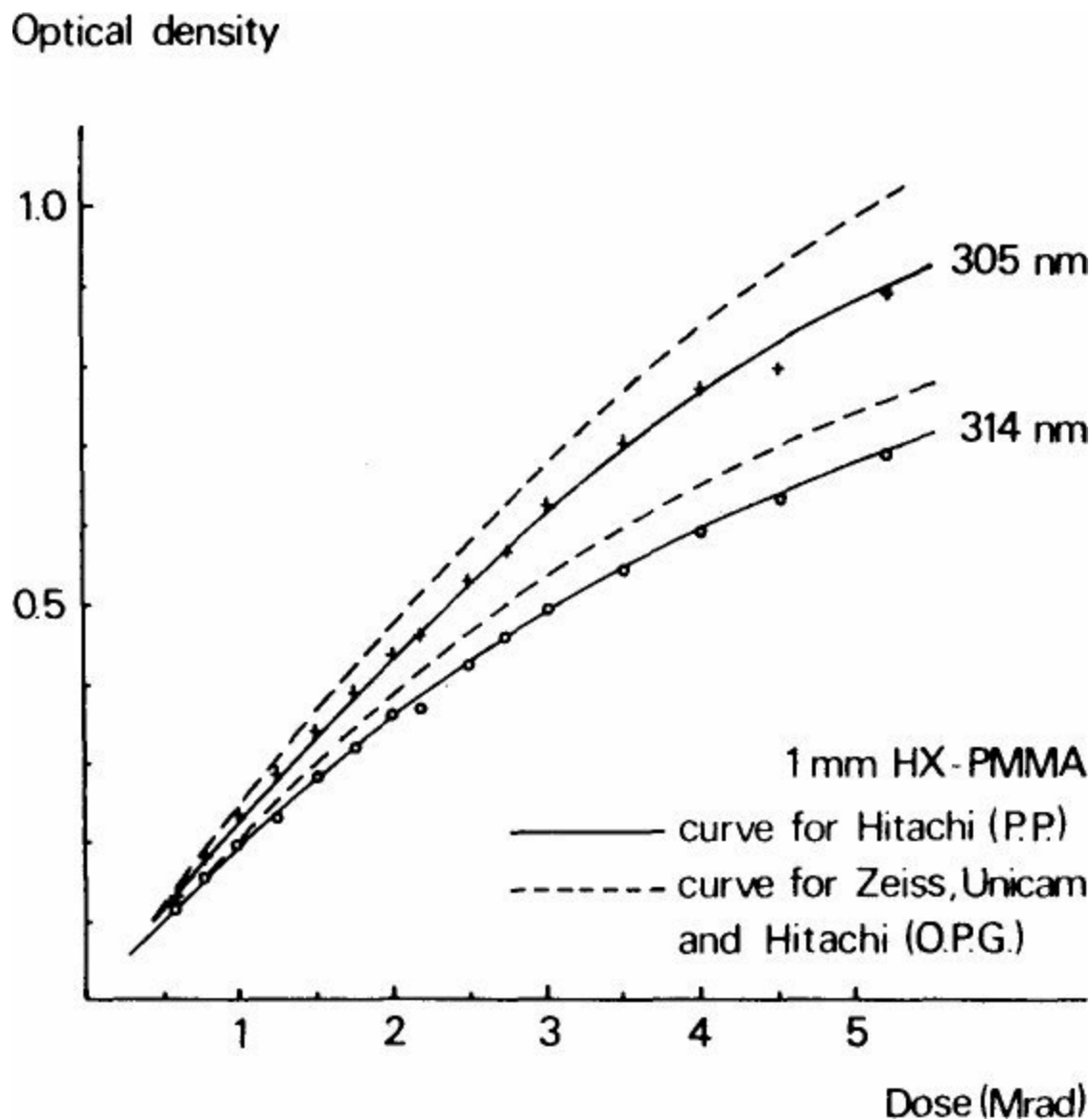

Figure 2. Difference in calibration curve of 1 mm HX Perspex™ measured on four different spectrophotometers. The same samples were measured on all four instruments.

Effects in Use

The dosimeter system will rarely be used in process measurements in exactly the same conditions as those applying when it was calibrated and it is necessary that the plant operator be aware of differences which may result in a deviation of the dosimeter from the calibrated response⁸. Some of these changes are relatively obvious, others are more insidious. In a machine plant and especially with electron irradiations the dose rate effect can be an important problem in the use of a dosimetry system. In a gamma irradiation plant problems of dose rate will seldom play a role, but some high dose irradiations may take up to 4-5 days and at this exposure time some dosimeter systems such as clear Perspex™, may begin to exhibit fading as a result of oxygen diffusion⁹. Another effect we have come up against is a

temperature-time effect¹⁰. In an irradiation of 40 hrs the product spent several hours at 35°C. The temperature induced a very slow conversion of one absorbing species into a second species in the clear Perspex™ dosimeter and resulted in a change of OD spectrum and a reading of dose 20% higher than expected. Figure 4 shows the reproduction of this effect in the laboratory and shows that the effect was dependent on measurement wavelength.

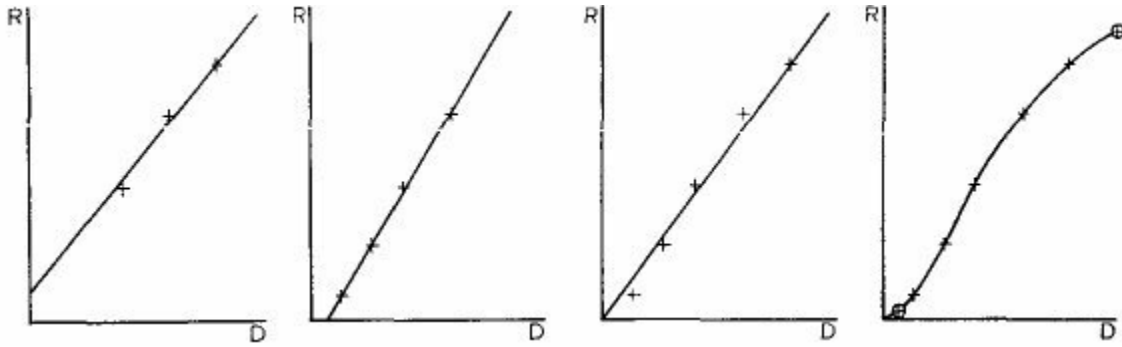

Figure 3. The linearity syndrome and the measurement of an accurate and useful dose response relationship.

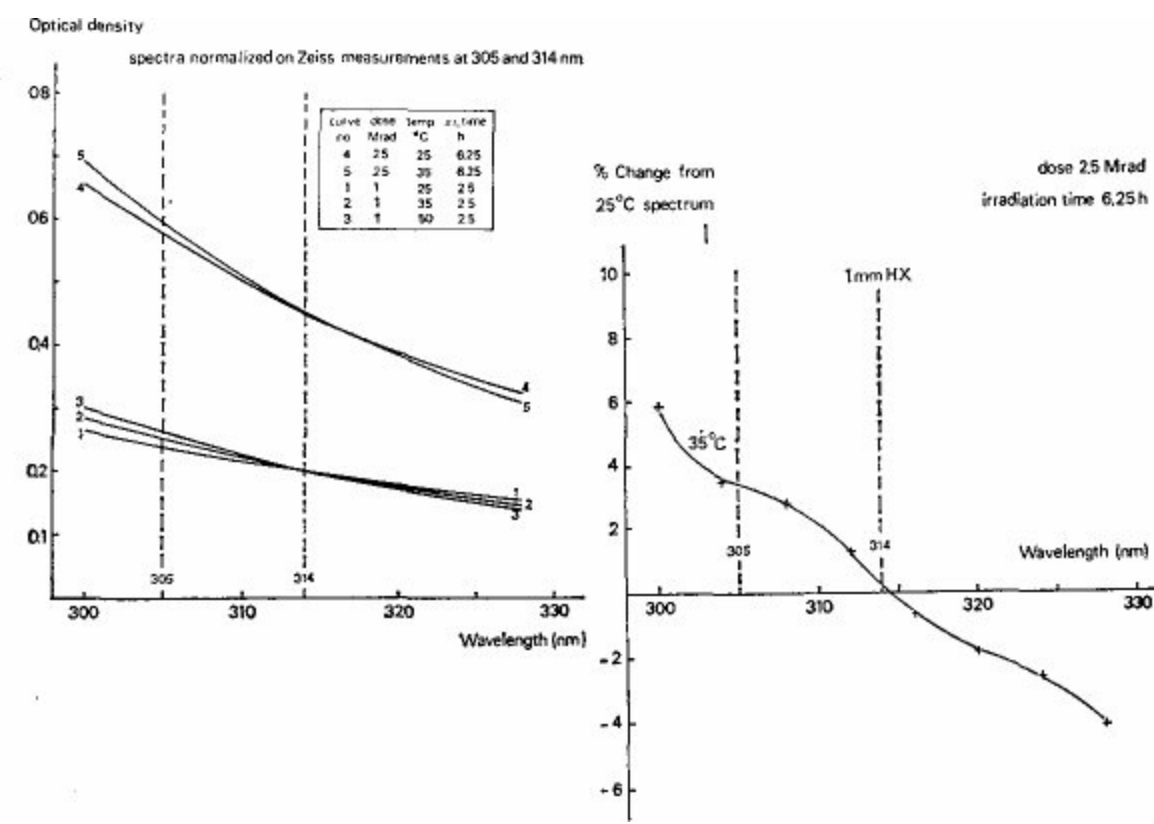

Figure 4. The influence of a temperature-time effect on the optical density spectrum of an irradiated 1 mm HX Perspex™ dosimeter.

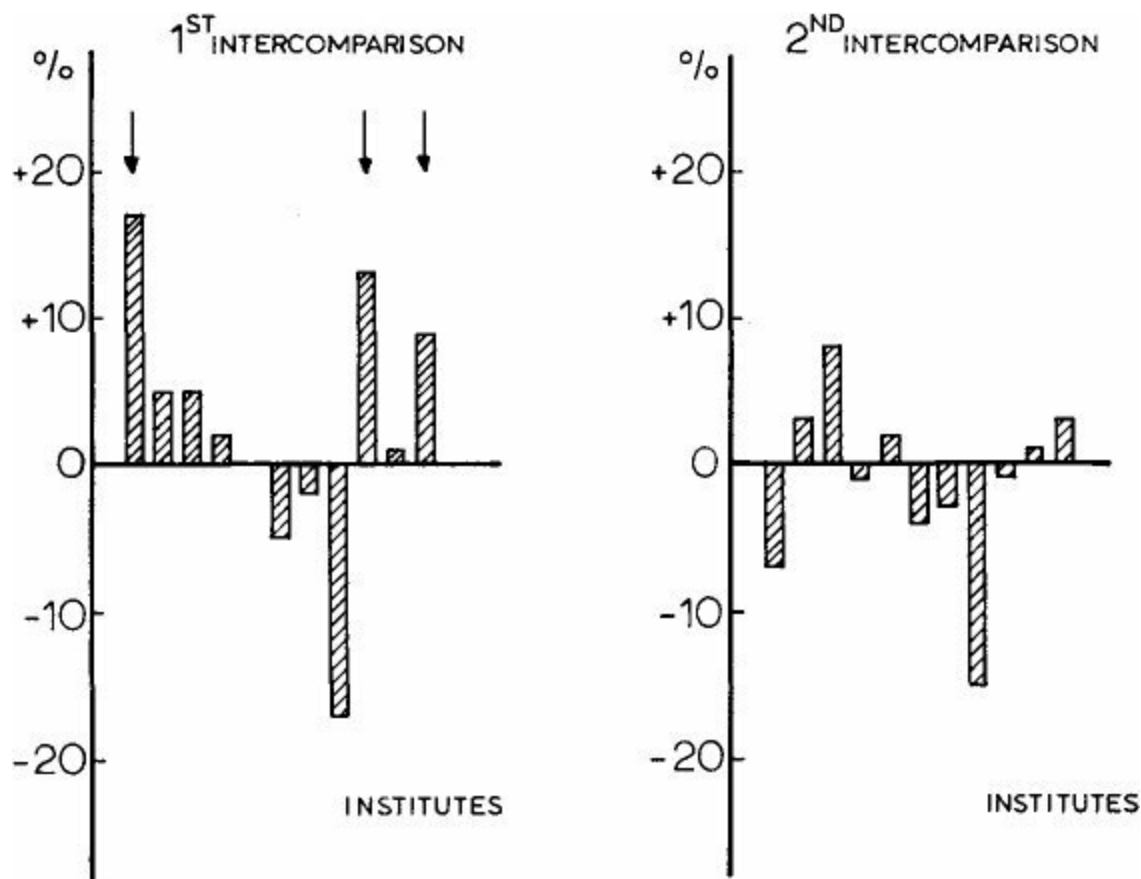

Figure 5. The influence of dose intercomparison on the absolute accuracy of dosimetry.

Intercomparison

I do not wish to give the impression that an intercomparison of dosimeters is an essential part of commissioning a process but I do feel that it can be extremely useful. To illustrate this point I would like to mention some results of an intercomparison carried out between several institutes in Europe which are involved in animal radiobiology¹¹. The radiation facility was usually an X ray set, the dose 200 rads. The Figure 5 shows the results of the two intercomparisons and illustrates the improvement which was achieved. The mean deviation of 11 institutes was improved from 7% to 4.3% mainly because institutes doing poor dosimetry were radically improved¹². Now I think we may expect that these radiobiological institutes would do better dosimetry under these conditions than the average irradiation plant operator under his working conditions. This is again a point for contemplation.

Calibration of the facility

The calibration of the facility involves the determination of the dose-time characteristic. In a gamma irradiation plant facility two typical situations arise, one is a 'shuffle-dwell' type of facility where the product remains in each position in the source for a pre-set dwell time and is transferred relatively quickly from position to position, the other where a continuous conveyor system is used and the product moves continuously through the source at a pre-set conveyor speed. Both systems result in a similar type of curve. In a machine irradiator other factors play a role such as beam current and scan frequency etc., but for a fixed set of conditions similar calibration curves can be established².

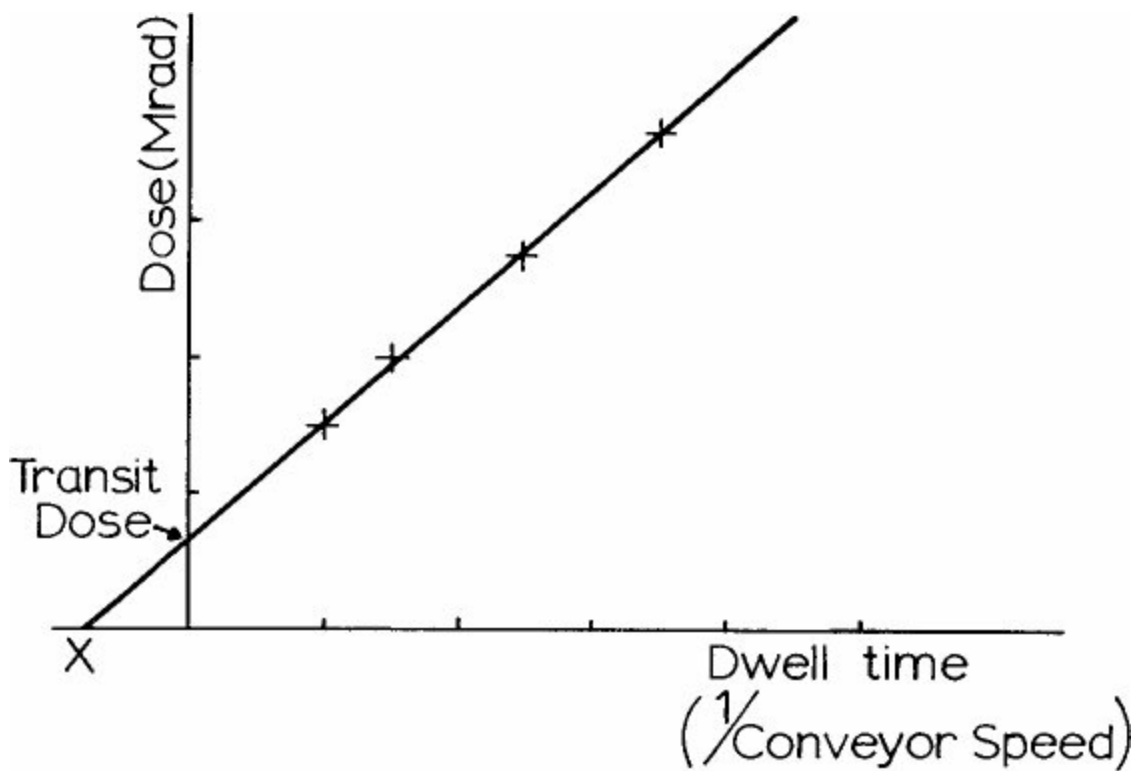

Figure 6. A typical dose versus dwell time ($1/\text{conveyor speed}$) curve giving the facility calibration.

The Dwell Time ($1/\text{conveyor speed}$) — Dose curve

The relationship between dwell time and dose will be linear but will not pass exactly through the origin as even when the dwell time is zero the product will receive a dose because of the transfer, and an entry and exit dose also will be accumulated. This transfer dose plus the entry and exit dose is normally referred to as the transit dose (Figure 6). In a continuous conveyor system type of facility only the entry and exit dose contribute to the transit dose.

The relationship can be determined by using a source filled with a uniform dummy product and measuring the dose in a standard position on a product package for several different dwell times or conveyor speeds. The linear regression line through these points gives a calibration of the facility (Figure 6), and more important gives the intersection of the calibration line with the time axis (X in the figure). It is important that a large enough number of dwell times is chosen, sufficiently well spaced, to ensure that the point X is accurately determined.

Characterization of the Product

The characterization of the product involves the determination of the position of minimum dose in the product, the measurement of the effect of the variation of bulk density on the spread of the minimum dose at a certain dwell-time, T1, and the use of the calibration curve to determine the correct dwell time, T2, to be able to say with a certain statistical confidence that the product receives the dose which is necessary to effect the process.

The Dose Distribution in the Product

In fact, the determination of the dose distribution throughout the product is not important but the

knowledge of the position of the minimum, and quite often the maximum, dose is indispensable^{1,2,12}. One thing should be made quite clear at this stage and that is that the concept of mean dose to the product has little meaning and is to be discouraged.

A rough dose-mapping of the product should indicate positions of minimum, and if necessary, maximum doses. An idea of these positions will almost certainly have been gained from plant designers and from measurements made during the commissioning of the plant.

The Effect of Variation in Bulk Density

A normal variation in bulk density in the product will lead to a variation in the value of the minimum dose.

If a number (d) of dosimeters are placed at the position of minimum dose in each of a series of n (say 20) randomly selected boxes of product which are irradiated at a pre-set dwell time T₁, then the minimum dose in each box can be estimated by D_{min}, the average reading of the dosimeters. The average \bar{D}_{min} of the D_{min} values and their standard error S_{BD} (an estimate of σ_{BD}) can then be calculated.

$$S_{BD} = \sqrt{\Sigma(D_{min} - \bar{D}_{min})^2 / n - 1}.$$

The value of σ_{BD} implicitly contains the standard deviation of the dosimeters σ_D , which was determined during the calibration of the dosimeter system. If the quantity (σ_D/d) is small, that is, the reproducibility of the dosimeter system is very good, then σ_{BD} will mainly be determined by variations in the bulk density which will in general be uncontrollable.

Determination of the Dwell Time to Achieve the Process

It is not possible to choose a dwell time and say with absolute certainty that all the product will receive more than the dose necessary to achieve the process. Therefore we must satisfy ourselves with a statement of statistical confidence.

For example: in order to say at a 95% confidence level that the probability that a randomly selected box of product receives a minimum dose less than the effective dose D_{eff} is 0.05 the following procedure should be used to determine the correct dwell time T₂. Take the calibration of the facility curve (Figure 6), plot $\bar{D}_{min} - 2.4 S_{BD}$ against T₁ on this figure and draw the straight line from X through this point. Use this new line to relate D_{eff} to the dwell time T₂. This procedure is illustrated in Figure 7 and it is assumed that the point X is accurately known.

DETERMINATION OF DWELL TIME TO EFFECT PROCESS

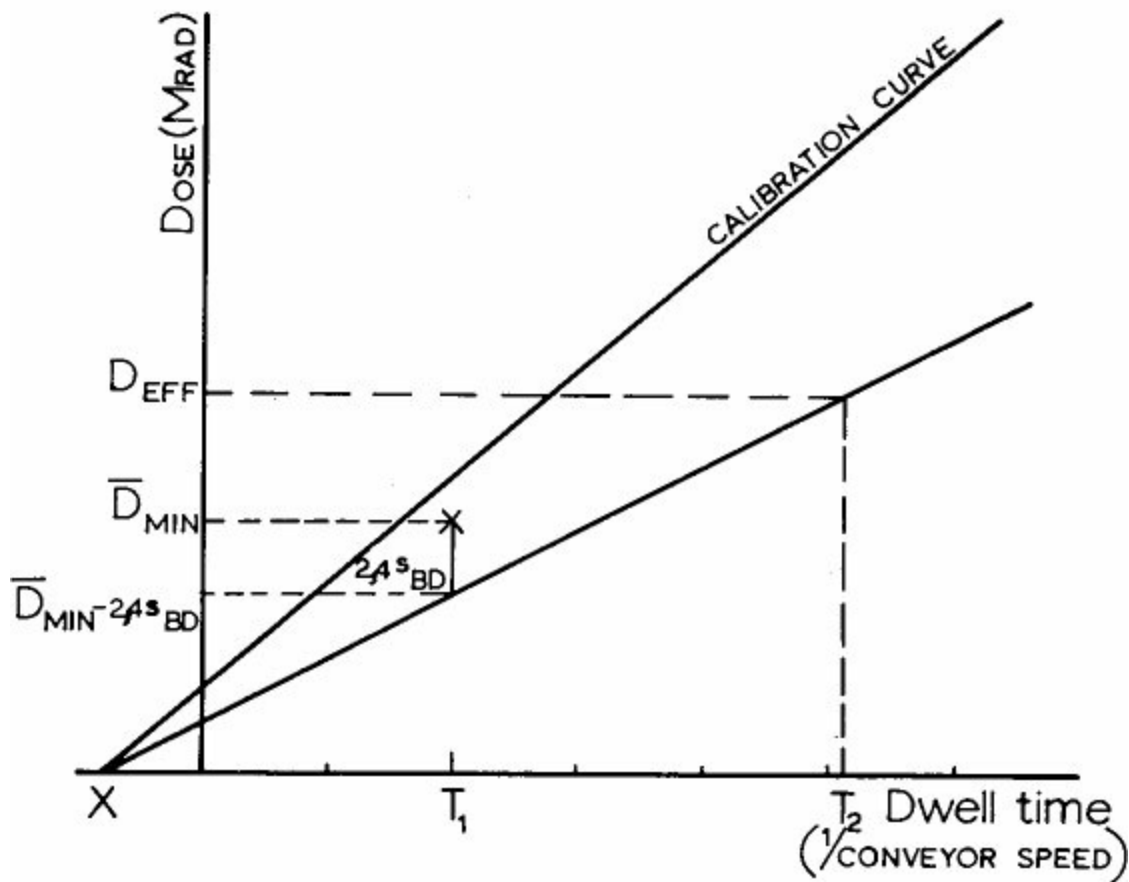

Figure 7. The determination of dwell-time T_2 necessary to achieve a process D_{eff} in the product with a certain degree of statistical confidence.

It is important to note that the level of statistical confidence (95%), the probability (0.05), the factor with which S_{BD} is multiplied (2.4) and the number of boxes (20) are all related. If a lower level of statistical confidence and/or a higher probability can be tolerated, and in view of the continuous nature of microorganism inactivation by radiation this may be possible, then either fewer boxes need to be screened or a smaller multiplication factor for the standard error S_{BD} , could be involved. A general indication of this interrelatedness is given in Table I.

Table I. The dependence of k, the factor with which S_{BD} is multiplied, on the choice of the level of statistical confidence (α), the probability (β) that a box of product has $D_{min} < D_{eff}$ and the number of boxes tested (n).

1. $\alpha = 0.05$, 95% confidence level

2. $\alpha = 0.025$, 97.5% confidence level

β					β				
	0.05	0.1	0.15	0.2		0.05	0.1	0.15	0.2
n					n				
8	3.2	2.6	2.2	1.9	8	3.8	3.0	2.5	2.2
10	2.8	2.3	2.0	1.7	10	3.1	2.6	2.2	1.9
15	2.5	2.0	1.8	1.5	15	2.8	2.3	1.9	1.7
20	2.4	1.9	1.6	1.4	20	2.5	2.1	1.7	1.5
30	2.2	1.8	1.5	1.3	30	2.4	1.9	1.5	1.4

Single user license provided by AAAM. Further copying, networking, and distribution prohibited.

It should be stressed that the above method is valid only if X is determined without appreciable error. The calibration line of Figure 6 should, therefore, be based on a wide range of dwell times. The effects of small errors in X grow more serious the further $(D_{\min} - kS_{BD})$ is removed from D_{eff} , where k is the factor with which S_{BD} is multiplied (2.4 in the example). Every effort should be made to choose T_1 in such a way that the difference between $(\overline{D_{\min} - kS_{BD}})$ and D_{eff} is likely to be small.

Establishing the Process

Having determined the dwell time T_2 to effect the process two further steps are necessary to establish the process, process control and inventory control.

Process Control

Control in an irradiator can be monitored in one of three ways.

- 1) By monitoring the irradiator parameters such as dose rate, beam current, mechanical positioning and conveyor time cycle.
- 2) By total dose measurements.
- 3) By product testing.

In a sterilization plant product testing will almost certainly be carried out to some extent. However, the best and most economical check is most probably the monitoring of the irradiator parameters as this can be done automatically and can be designed into the plant. At the same time the measurement of the conveyor time cycle (dwell time or conveyor speed) can be done accurately and used statistically in a quality control system. The use of dosimeters is considered to be the least useful method of the three for process control, it is less accurate than a time measurement on the whole and will be generally more costly. Random checks on an *ad hoc* basis using dosimeters however do have some merit for the control of the source but not of the process.

Inventory Control

As a final step in the commissioning, the plant operator must set up a form of inventory control which ensures that the product is irradiated, but only once.

A plant can be designed so that irradiated material cannot be normally mixed with unirradiated material but this is rarely completely fool-proof.

An additional useful check which also is a control against accidental double irradiation is the use of what are normally called go/no-go dosimeters. These can be in the form of sticky labels or printing ink on the outside of packages which change colour on irradiation. I personally do not regard these systems as an indication that a package has received a certain dose of radiation but only that the colour change is an indication that the package has been irradiated. If such a radiation indicator is used care should be taken to ensure that it is not sensitive to heat, light and other environmental effects.

Discussion

An important aspect of the use of radiation for the sterilization of medical products is that by using the correct dosimetry techniques during the commissioning of a process an irradiation plant operator

can guarantee within statistical limits that 'all' the product has received a dose of radiation high enough to effect the process of sterilization.

It is clear that the dosimetry techniques for commissioning a process, the measurement of dose distributions, the calibration of the facility and the determination of the time parameter all depend on the calibration of the dosimeter and also the reproducibility of the dosimeter so that the choice and calibration of the dosimeter forms an important aspect of the commissioning procedure. The reproducibility of the dosimeter system can also affect the economics of the process if it is so poor that it plays an important role in the determination of the standard deviation caused by the variation in bulk density of the product. The bigger the standard deviation the longer the dwell time needed to achieve the process with a statistical degree of confidence. The longer the dwell time the lower the throughput.

In this paper the determination of the minimum dose in a product has been taken as the most important parameter. This is probably true for the sterilization process; however, in some cases it may be necessary to know the maximum dose given to the product. This can be obtained in the same way as has been described for the minimum dose except that the statement of statistical confidence applies to the $\bar{D}_{\max} + 2.4 S_{BD}$.

One other important point which I feel deserves further consideration concerns the statement of statistical confidence. The choice of the level of statistical confidence and the probability of failure to achieve the effective dose are problems, especially for the authorizing body, and involve consideration of the inactivation dose kinetics of the microorganisms involved, of the work involved in the commissioning dosimetry and of the economics of the process. It is probably a problem which should be solved by cooperation between the microbiologists, the dosimetrists, the statisticians, the authorizing bodies and the plant operators and it would be pleasant if one level of statistical confidence and one probability could be agreed upon internationally.

Acknowledgement

The basic theme of this paper owes its origin to the discussions I have had with L. Chandler, D. Ehlerman, W. L. McLaughlin, F. X. Rizzo and Y. Takashima during the preparation of a Dosimetry Manual for Food Irradiation under the auspices of the International Atomic Energy Agency. I also wish to acknowledge the help of A. Heyting and A. Keen (Institute for Mathematics, Information Retrieval and Statistics, Wageningen) in the derivation of the statistical confidence levels.

This publication is contribution No. 1001 of the Biology Division of the Commission of the European Communities.

References

1. Weiss, J. and Rizzo, F. X. (1970) Cobalt-60 dosimetry in radiation research and processing. In *Manual on Radiation Dosimetry*, ed. Holm, N. W. and Berry, R. J., Marcel Dekker, Inc., New York, pp. 231-260.
2. *Dosimetry Manual for Food Irradiation*, IAEA, Vienna (In press) Title "Dosimetry for the Radiation Processing of Food".
3. McLaughlin, W. L., Solid State Effects Dosimeters, A comparison (These proceedings).
4. Draganić, I. G., Solution Chemical Dosimeters (These proceedings).
5. Sehested, K. (1970) The Fricke dosimeter. In *Manual on Radiation Dosimetry*, ed. Holm, N. W. and Berry, R. J., Marcel Dekker, Inc., New York, pp. 313-317.
6. Chadwick, K. H., ten Broeke, W. R. R. and Rintjema, D. (1973) An intercomparison of read-out systems for the clear perspex dosimeter. In *National and International Radiation Dose Comparisons*, IAEA, Vienna, pp. 33-40.
7. Edisbury, J. R. (1969) *Practical Hints on Absorption Spectrometry*. Adam Hilger Ltd., London.

8. Holm, N. W. and Berry, R. J. (1970) Part 2. Procedures in Radiation Dosimetry. In *Manual on Radiation Dosimetry*, ed. Holm N. W. and Berry, R. J., Marcel Dekker, Inc., New York, pp. 313-433.
9. Chadwick, K. H. (1970) An interpretation of the optical density — dose relationship in irradiated clear polymethyl methacrylate. *Radiat. Res.* 44: 282-295.
10. Chadwick, K. H. (1973) The choice of measurement wavelength for clear HX-perspex dosimetry. In *Dosimetry in Agriculture, Industry, Biology and Medicine*. IAEA, Vienna, pp. 563-568.
11. Broerse, J. J. and Puite, K. J. (1973) Comparisons of X-ray dosimetry for the coordination of late effects research in Europe. In *National and International Radiation Dose Intercomparisons*. IAEA, Vienna, pp. 21-31.
12. Broerse, J. J. and Puite, K. J. (1973) (personal communication).
13. Fielden, E. M. and Holm, N. W. (1970) Dosimetry in accelerator research and processing. In *Manual on Radiation Dosimetry*, ed. Holm, N. W. and Berry, R. J., Marcel Dekker, Inc., New York, pp. 261-309.
14. Owen, D. B., (1963) Factors for one-sided tolerance limits and for variables sampling plans. p 9 and Tables 2. S.C.R. 607 Disc, by NTIS, U.S. Dept. of Commerce, 5285, Port Royal Rd., Springfield, Va. 22151.

Some Dose Rate Considerations in Radiation Chemistry and Radiobiology

G. E. Adams and P. Wardman

Cancer Research Campaign, Gray Laboratory, Mount Vernon Hospital, Northwood, Middlesex HA6 2RN, England.

Abstract: *The nature and time scale of the physical, chemical and biological events resulting from the absorption of ionising radiation are outlined. The physical stage (ionisation, excitation, ion-molecule reactions, ion solvation) covers the time scale $\sim 10^{-18}$ to 10^{-12} seconds. After ion solvation, the chemical stage continues with radical-radical reactions in spurs followed by diffusion to produce an homogeneous distribution of products by about 10^{-7} seconds. Chemical reactions may take place from $< 10^{-12}$ seconds to slow biochemical reactions taking hours. Biological damage at the single cell level can be observed hours after exposure, but long term effects such as genetic damage or carcinogenesis may occur many years after exposure.*

The Fricke dosimeter is used to illustrate the occurrence of dose-rate effects on the efficiency of chemical damage at the very high dose rates of $\sim 10^9$ to 10^{10} rads sec^{-1} , when radical-radical reactions become important. Even at low dose rates, an apparent dose rate effect can be observed if the chemical or biological system is sensitive to the presence of oxygen, which may be consumed after a dose of ~ 50 krad unless replenished. This effect is readily observed in biological systems; break-point phenomena and results from fast time-response experiments at the cellular level are given as examples.

Introduction

The time-scale of radiation action spans at least twenty-five orders of magnitude extending from the earliest physical events following passage of a high energy particle or quantum through a small atom, to genetic effects which may not manifest themselves until many years after irradiation. At all levels of biological complexity, the overall response is governed by the interplay of physical, chemical and biological processes, each of which may be affected by the rate at which energy is absorbed. The object of this paper is to discuss briefly some of the factors which may contribute to dose-rate effects in both radiation chemistry and biology.

Time Scales of Radiation Action

It is convenient to define three time scales of radiation action, namely, physical, chemical and biological (see Table I).

Table I. — The time scale of radiation damage

(illustrated by aqueous systems at 300 K)

(Seconds)

10^{-18}

Fast particle traverses small atom

10^{-16}

Ionisation $\text{H}_2\text{O} \xrightarrow{\gamma} \text{H}_2\text{O}^+ + \text{e}^-$

10^{-15}	'Physical stage'	Electronic excitation $\text{H}_2\text{O} \xrightarrow{\text{---}} \text{H}_2\text{O}^*$
10^{-14}		Ion-molecule reactions $\text{H}_2\text{O}^+ + \text{H}_2\text{O} \rightarrow \dot{\text{O}}\text{H} + \text{H}_3\text{O}^+$
10^{-13}		Molecular vibrations: dissociation of excited states possible $\text{H}_2\text{O}^* \rightarrow \dot{\text{H}} + \dot{\text{O}}\text{H}$
10^{-12}		Rotational relaxation: hydration of ions $e^- \rightarrow e^-_{aq}$
<hr/>		
$<10^{-12}$		Reactions of e^- before hydration with reactive solutes at high concentration
10^{-10}		Reaction of e^-_{aq} and other radicals with reactive solutes (concentration ~ 1 M)
$<10^{-7}$		Reactions in spur
10^{-7}	'Chemical stage'	Homogenous distribution of radicals
10^{-3}		Reaction of e^-_{aq} and other radicals with reactive solute (concentration $\sim 10^{-7}$ M, i.e. ~ 0.01 ppm)
1		Free radical reactions largely complete
1 to 10^3		Biochemical processes
<hr/>		
hours		cell division affected in micro-organisms
days	'Biological stage'	damage to central nervous system and gastro intestinal tract evident
\sim month		haemopoietic death
years		carcinogenesis and genetic damage

The physical stage

This is the period when energy is transferred from the high energy particle or quantum to the atoms of the absorbing medium and includes the various processes by which these atoms or molecules lose or redistribute this acquired energy. The time required for a high energy particle to pass through a small atom is about 10^{-18} seconds.

Electrons ejected in the primary ionisation process which occurs in about 10^{-17} seconds, lose energy by secondary ionisation and excitation processes and eventually become thermalised. Electronic excitation occurs at about 10^{-16} - 10^{-15} seconds. Changes in molecular configuration due to vibrational excitation are somewhat slower since they are limited by the inertia of the atoms and the binding forces between them. For most bonds in simple molecules, vibration periods usually lie in the range 10^{-14} - 10^{-13} seconds.

Rotational excitation frequencies are naturally smaller and can extend over quite a wide time range from about 10^{-12} seconds. Rotational energy is particularly important in polar condensed media, e.g. water, since it controls the solvation processes of charged ions produced by the radiation. These processes can be considered to mark the beginning of the chemical stage. In water, electrostatic interaction with the thermalised secondary electrons causes reorientation of the solvent molecules through dipole interaction. The dielectric relaxation time in water at room temperature is a few picoseconds and is the time of formation of the 'hydrated electron' one of the most important reactive species in radiation chemistry¹.

The hydrated electron, e^-_{aq} , is the major reducing species formed in irradiated solutions and, under some conditions, may have lifetimes extending into the micro- or even milli-second time range. The oxidizing species, the hydroxyl radical ($\dot{\text{O}}\text{H}$) is formed extremely rapidly from the positive ion H_2O^+ by the ion-molecule reaction



This process occurs before the dielectric relaxes: i.e. before solvation can provide energy for stabilisation of H_2O^+ .

Some hydrogen atoms (about 20% of the total number of reducing species) are also formed possibly both by dissociation of electronically excited water molecules and by protonation of e^-_{aq} .

The chemical stage

In water the chemical stage extends from about 10^{-12} seconds. Initially, the primary water radicals, e^-_{aq} , $\dot{\text{O}}\text{H}$ and $\dot{\text{H}}$ although in thermal equilibrium with the solvent, are not homogeneously distributed throughout the medium. These radicals are formed along the track, or 'spurs', of the ionising particle and then diffuse out into the bulk of the solution. Since the diffusion coefficients for $\dot{\text{O}}\text{H}$ and e^-_{aq} are 2.3×10^{-5} and $4.9 \times 10^{-5} \text{ cm}^2 \text{ sec}^{-1}$, respectively homogeneous distribution is not achieved until after about 10^{-7} seconds.

Rate constants for reactions between these radicals are of the order of $10^{10} \text{ M}^{-1} \text{ sec}^{-1}$ (see later) and, therefore, since radical concentrations in the spur are initially very high, some radical-radical interactions will occur during the period of diffusion out into the bulk of the solution. This is illustrated by the formation of the so-called 'molecular yields' of hydrogen peroxide and hydrogen gas. For high LET radiation fewer radicals escape the spur to become available for reaction with solutes present in the medium.

The time scale for reaction of the water radicals with the solutes is obviously governed by both solute concentration and their reactivities. The time scale for homogeneous free radical-solute reactions can be as short as 10^{-10} seconds if the solute concentrations are of the order of one molar.

The chemical stage continues with the reaction of the products of the radical reactions with other constituents in the medium. In a biological system this would correspond to the onset of various biochemical processes possibly involving enzymes. Reactions of this type can proceed over a wide range of time scales extending from seconds to hours.

The biological stage

Radiation damage at the single cell level become apparent when cell division is less efficient, becomes considerably delayed or ceases altogether. Time scales for such effects, therefore, are of the orders of an hour or a few hours in micro-organisms and somewhat longer in mammalian cells in culture.

At the level of multicellular organised tissue, biological effects become manifest much later extending from damage to the central nervous system or the gastro-intestinal tract in a few days, haemopoietic death in 30-60 days, to long term effects such as carcinogenesis or genetic damage which may not be observable until many years after exposure.

Chemical Effects of High Dose Rates

In systems containing two or more components, ranging from dilute aqueous solutions through

suspensions of single cells to organised tissue, the amount of energy deposited and hence the amount of ionisation and excitation produced in each component is proportional to the electron (i.e. weight) fraction of each component in the system. Therefore, since about 70-80% of the mass of the cell is water, a major fraction of the chemical damage will arise from the 'indirect' chemical action of free radicals originating from radiolysis of the intracellular water.

These primary 'water' free radicals (hydrated electrons, hydrogen atoms and hydroxyl radicals) react at virtually every collision with many inorganic or organic solutes, but their reactivities with each other are also generally equally high. Thus the reactions

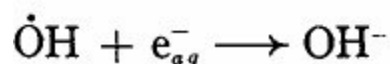
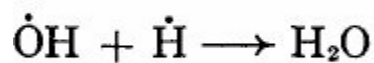
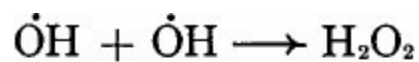

will tend to reduce the overall radiation damage since they either 'repair' the original dissociation of water or give molecular products of much lower reactivity.

In systems irradiated at high dose rates, competing radical-radical reactions of this type will become important and must be considered in the formulation of the chemical kinetics of the system. The rate of an individual reaction is proportional to the product of the concentrations of the reactants and a rate constant k which can be easily measured in some simple systems and often estimated in others. Thus, if we are interested in the chemical oxidation or reduction of a solute S by a radical X derived from the radiolysis of water,



then the rate of change of S is given by

$$-d[S]/dt = k_a [X] [S]$$

where square brackets denote concentration. If, however, the radical reacts with itself, e.g.

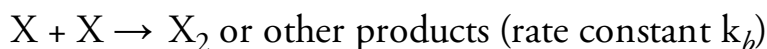

to produce products unreactive to S , then the rate of removal of S will be diminished if the dose rate is so high that $k_a [X] [S]$ is no longer much greater than $2k_b[X]^2$. Since it is often the case that $k_a \simeq k_b$, then the general condition for the absence of dose rate effects is that the concentration of the solute(s) shall be much greater than the instantaneous concentration of the reactive free radicals in the system.

An order of magnitude estimate of the concentration of free radicals may be made by equating their rate of production with their rate of removal in order to obtain the *steady state* concentration under continuous irradiation. Irradiation of water produces about $6 \mu\text{M}$ ($\sim 0.1 \text{ ppm}$) of free radicals per krad dose absorbed. Thus, with typical rate constants $k_a \simeq k_b \simeq 5 \times 10^9 \text{ M}^{-1} \text{ sec}^{-1}$, a solute concentration $[S]$ as low as 10^{-13} M ($\sim 20 \text{ ppm}$) and the very high continuous dose rate of $10^9 \text{ rad sec}^{-1}$

$$\text{rate of production of } X \simeq 6 \times 10^{-3} \text{ M sec}^{-1}$$

$$\text{rate of destruction of } X \simeq 5 \times 10^9 \times 10^{-3} \times [X]$$

and $[X] \simeq \frac{6 \times 10^{-3}}{5 \times 10^6} \simeq 10^{-9}$ M at steady state.

Thus, even under these conditions of low [S] and high continuous dose rate, $[S] \gg [X]$ and removal of X by self reaction or by reaction with another radical will be negligible.

The fact should not be overlooked that S is being removed initially at a rate of 6×10^{-3} M sec⁻¹ and at a decreasing rate as S is consumed. Since the initial concentration of S is only 10^{-3} M in this example, after a fraction of a second of irradiation at this dose rate most of S will have been consumed. This is an effect of total *dose* rather than *dose rate* in a system where the solute S is not being replenished. However, there is one important example where the consumption of S can lead to dose *rate* effects.

The concentration of oxygen in air-saturated aqueous solutions is of the same order ($\sim 0.3 \times 10^{-3}$ M) as the concentration of S in the example above. In a closed system where oxygen is *not* being continually replaced by vigorous stirring or bubbling, irradiation of aerated water will consume all the oxygen after a dose of ~ 50 krads by the reactions

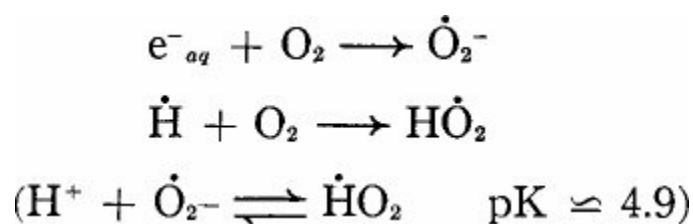

If, however, the oxygen is being continually replenished, then the likelihood of dose rate effects will depend on the competition between loss by radiolysis and replenishment by physical diffusion.

Whilst for moderate dose rates, replenishment of oxygen in aqueous solutions is readily achieved by simple shaking or bubbling with air, in systems such as solid plastics where the diffusion coefficient of oxygen is much less than that for liquid water, dose rate effects are much more likely.

The example above involves dose rates of the same order as those achievable under continuous irradiation with a d.c. beam from a Van deGraaff electron generator. Pulsed irradiation sources can deliver doses to a fairly small field at instantaneous rates many orders of magnitude higher than this ranging up to about 10^{14} rads/sec. For a pulsed source delivering 10 krad in 1 μ sec the concentration of free radicals at the end of the pulse could be up to about 10^{-4} M. If the solute concentration is not much greater than this there will be a considerable effect due to the occurrence of radical-radical reactions.

The Fricke dosimeter

This dosimeter provides an example of the effect of consumption of oxygen even at low dose rates and of a diminishing yield of oxidation at high dose rates. The system is based on the radiation-induced oxidation of ferrous ion to ferric ion in acidic oxygenated aqueous solution. The mechanism is:

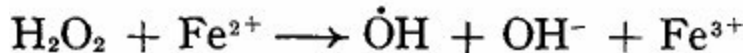
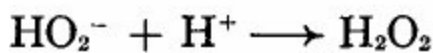
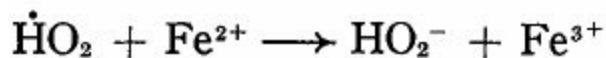
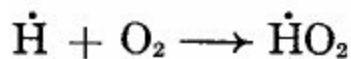
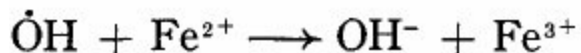
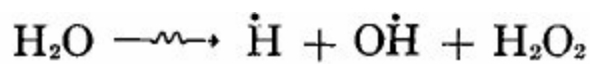

Thus, each hydrogen atom results in the oxidation of 3 ferrous ions, each molecule of H_2O_2 gives 2 ferric ions and each $\dot{\text{O}}\text{H}$ radical oxidizes one ferrous ion. In the absence of oxygen, hydrogen atoms oxidise only one ferrous ion per atom,

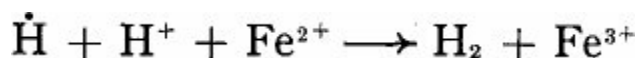

so that the net oxidation yield will be diminished.

The production of H atoms in this acid solution is at a rate of $4 \mu\text{M}$ per krad dose absorbed. The concentration of oxygen in air-saturated water is $\sim 270 \mu\text{M}$ so that if the vessel is closed to air the oxygen will be consumed after a dose of ~ 60 krad. Experimentally, a decrease in the slope of the plot of the concentration of ferric ions versus dose is observed at about this dose as the yield of ferric ions per H atom decreases from 3 to 1 (Figure 1).

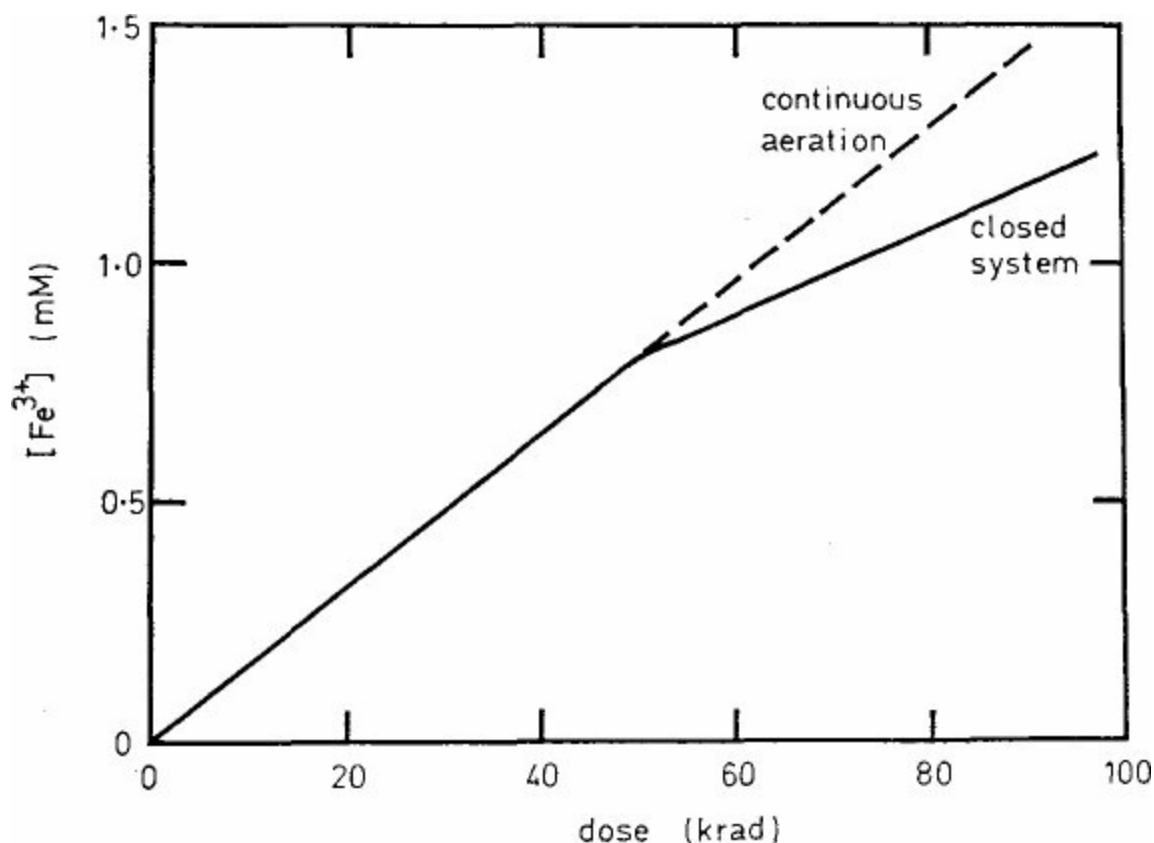
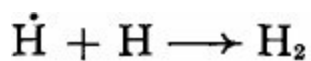
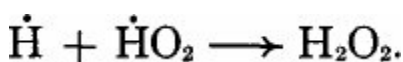

Figure 1. Effect of oxygen depletion in the Fricke dosimeter at low dose rates.

At high dose rates, the yield of ferric ion decreases because the H atoms are removed by reactions which either give inert products



or produce less overall oxidation:



These reactions are in competition with removal of H atoms by reaction with oxygen, so if the dose rate is just high enough to show a decrease in the Fe^{3+} ion yield in air saturated solutions, the full yield may be partially or wholly restored by saturating the solution with oxygen rather than air and by increasing the concentration of Fe^{2+} ions (Figure 2). It should be noted that these high dose rate experiments involve total doses of < 50 krad so that oxygen consumption is not a problem.

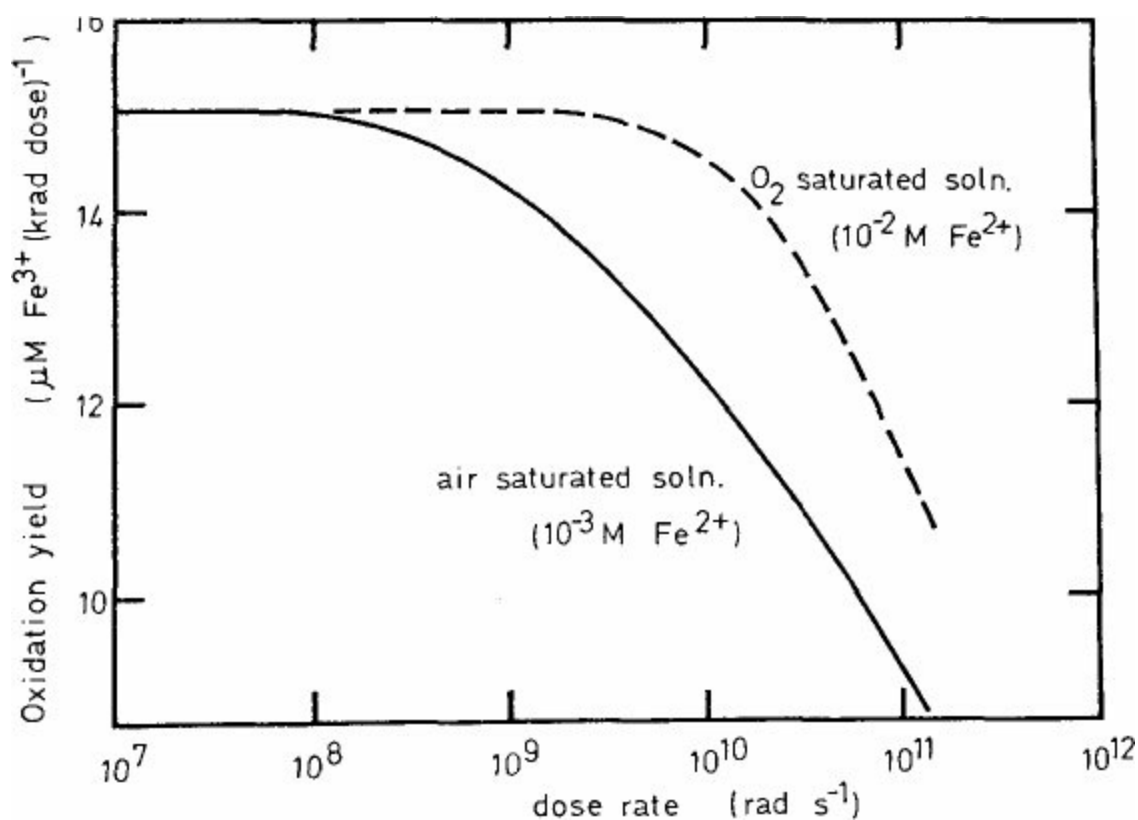

Figure 2. Effect of radical-radical reactions in the Fricke dosimeter at high dose rates. Data from Thomas and Hart (ref. 2).

The dose rates required to show a reduction in Fe^{3+} ion yield in the Fricke dosimeter are very high, i.e. $\sim 10^9$ rads sec^{-1} with aerated solutions and $\sim 10^{10}$ rads sec^{-1} with oxygenated solutions. Although the radical-radical 'back' reactions listed above are very fast (diffusion controlled) so is the reaction of H with O_2 to produce HO_2 . In oxygen-saturated water the half life of a hydrogen atom disappearing by this reaction is $\sim 3 \times 10^{-8}$ seconds.

High Dose Rate Effects at the Cellular Level

In a cellular system, the high local concentration of reactive organic material will ensure that the free radical products of the radiolysis of intracellular water will have an extremely short life time. Their diffusion distance will be of molecular dimensions only and they will disappear by bimolecular reaction

with neighbouring reactive molecules. Inter-radical reactions will be most unlikely. For this reason dose rate effects due to such chemical processes are not observed in cellular systems even at the highest dose rates obtainable with pulsed machines. However, effects due to oxygen depletion can occur under some conditions and these can give rise to apparent *dose rate* effects. The most well known example of this is the “Dewey-Boag” effect³.

The Dewey-Boag effect

It is almost universally true throughout radiobiology that absolute radiosensitivities at the cellular level are greater in the presence of oxygen than they are in anoxia. The sensitising effect of oxygen on cells irradiated in the presence of oxygen compared with cells irradiated in anoxia is virtually evident throughout all cellular radiobiology. In many cellular systems, the lethal effect of radiation is a simple exponential function of dose in both oxygen and anoxia. However, in some cases, the plot of logarithmic cell survival against dose exhibits a small shoulder or resistant portion. In a given system the ratio of the slopes of the linear portion of these ‘survival curves’ for oxygen and nitrogen is the oxygen enhancement ratio (OER). For low LET radiation, values of OER usually fall between 2 and 4 for micro-organisms and is approximately 3 for mammalian cells.

The experiments of Dewey and Boag were designed to compare the radiosensitivity of the micro-organism *Serratia marcescens* irradiated with low dose X-rays with that observed when the bacteria are irradiated with a single 2 μ s pulse from an electron linear accelerator (Figure 3).

The lines labelled ‘X-ray’ are the survival curves for *Serratia marcescens* irradiated in the absence of oxygen and in medium containing either 1% or 100% oxygen. The full OER is 3.1 under these conditions. The open circles on the upper line are the data for anoxic bacteria irradiated at a high dose rate with single 2 μ sec pulses of electrons and the closed circles the corresponding data for 1% oxygen. With the low dose rate X-rays, 1% oxygen is sufficient to produce 60-70% of the full oxygen effect. In contrast, bacteria which were pulse irradiated in the presence of 1% O₂ show the same radiation sensitivity as the hypoxic bacteria.

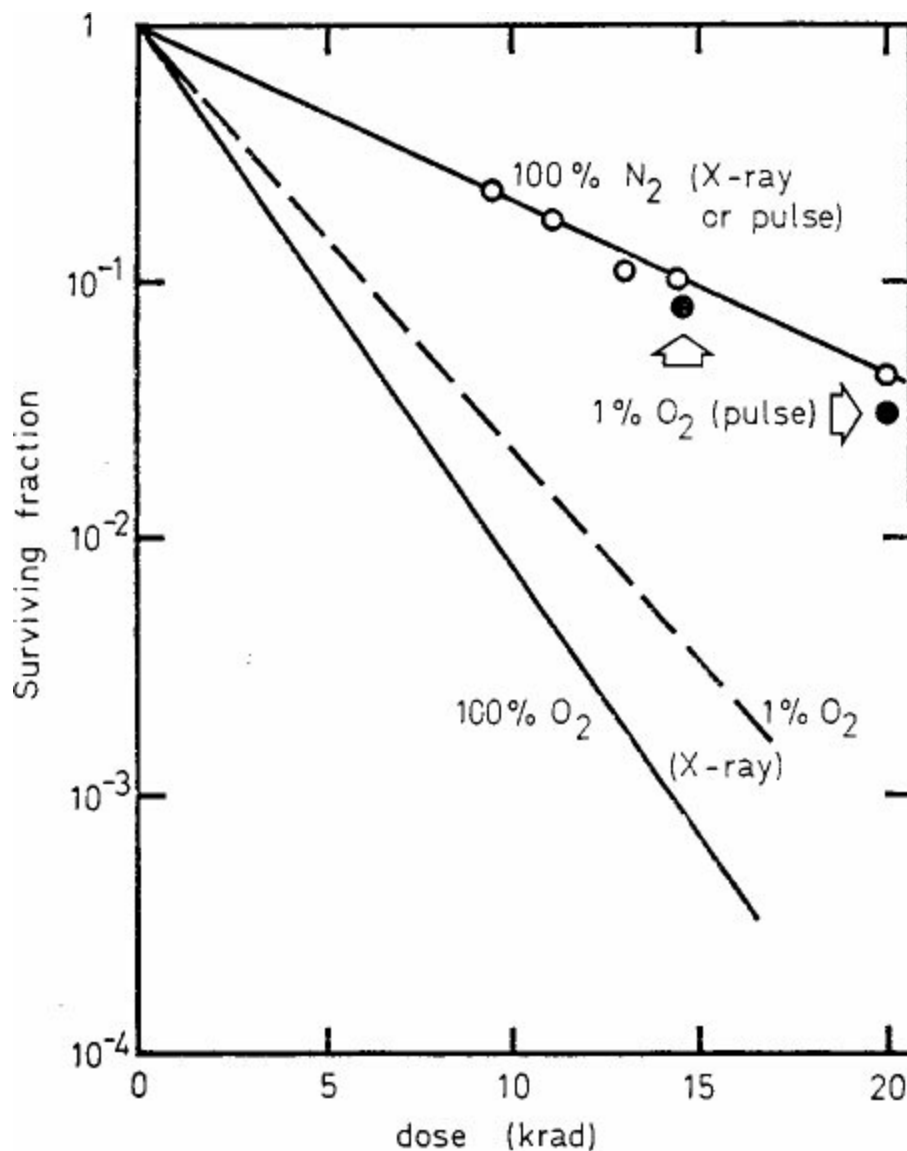

Figure 3. Radiosensitivity of *Serratia marcescens* irradiated at low dose rates (X-ray) and at dose rates of $\sim 10^{10}$ rad s^{-1} (pulse). Data from Dewey and Boag (ref. 3).

In the pulsed experiments, the suspensions were irradiated in a closed system. Under these conditions, doses of 15-20 krad are more than sufficient to consume by radiolytic action all oxygen present both in the medium and inside the cell. The rate of oxygen consumption in the low dose rate experiments is much less than the rate at which intracellular oxygen can be replaced by diffusion from the medium continually bubbled with oxygen.

Oxygen depletion under high dose rate conditions is a dose effect, therefore, rather than true dose rate effect. This is illustrated in more detail by the data of Epp and co-workers⁴ who studied the sensitivity of *E. coli* B/r to a 30 nanosecond pulse of electrons for a range of doses and oxygen concentration.

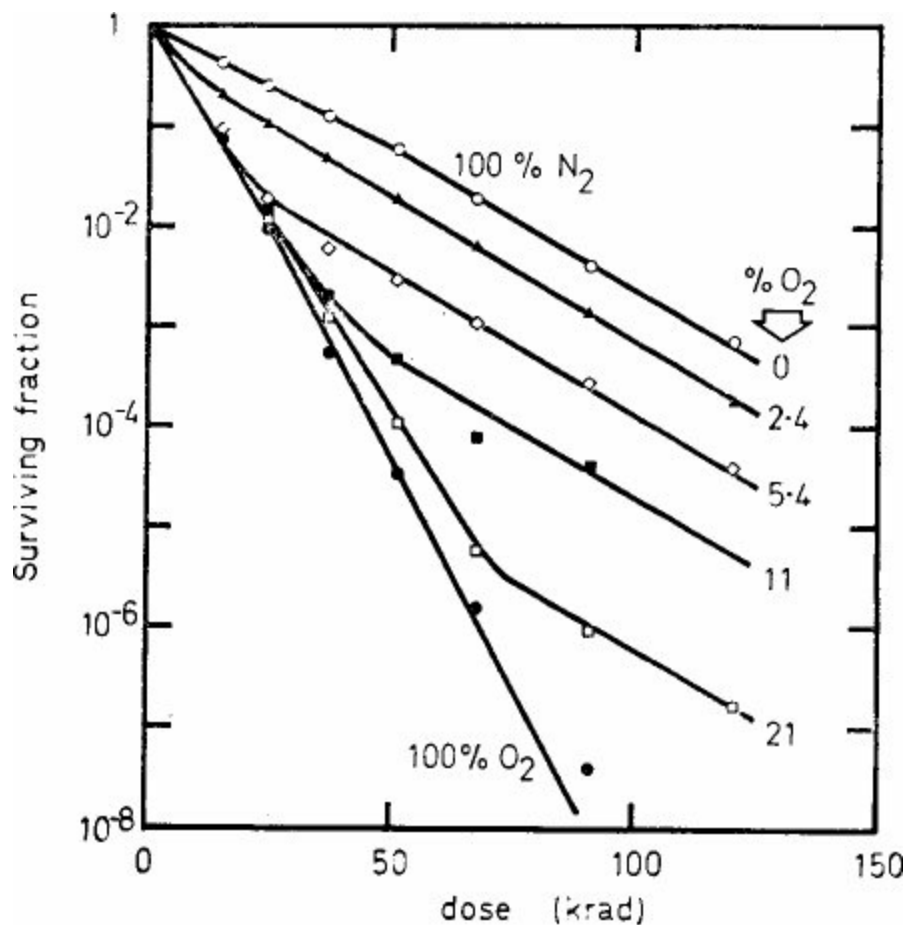

Figure 4. Radiosensitivity of *E. coli* B/r irradiated with single 30 ns pulses (dose rate $\sim 2 \times 10^{12}$ rad s^{-1}) at various oxygen concentrations. Data from Epp *et al.* (ref. 4).

The curves for nitrogen and 100% oxygen follow simple exponential survival kinetics (Figure 4) but for lower concentrations of oxygen, the curves exhibit two distinct components. The 'break points' in each of the curves occur at the doses where radiolytic depletion of oxygen inside the cell becomes critical. In contrast to the bacterial suspensions used by Dewey and Boag, oxygen is present in the gaseous environment around the cells in the experiments of Epp and co-workers. Radiolytic consumption of oxygen *extracellularly* is much less efficient in the gas phase than it is in suspension. However, the rate of diffusion of oxygen into the bacteria is less than the rate of its consumption inside the cell and so the break point phenomenon is observed.

Life-time of oxygen dependent damage

In other experiments^{5,6}, Epp and colleagues used the break point technique to explore the life-time of the oxygen dependent damage and the time scale for diffusion of oxygen into the bacteria *E. coli* B/r. In these experiments bacteria held on a Millipore filter in contact with a gas mixture containing a known amount of oxygen are exposed to *two* pulses of electrons. The pulses can be separated in time by amounts ranging from microseconds to seconds or longer. The first pulse is sufficiently large to consume by radiolytic action all the oxygen inside the cell. If the time required for oxygen to diffuse into the cell is longer than the the time interval before the second pulse, the radiation response to the second pulse will be that of anoxic bacteria. If, however, the time is shorter than the pulse separation time, the cells will become re-oxygenated and will be correspondingly more sensitive to the second pulse. Some of the data are reproduced in Figure 5 for oxygen concentrations in the gas phase of 4%.

From experiments of this type it was concluded that, under these conditions, the upper limit for the life time of the oxygen-sensitive damage in the bacteria was 10^{-4} seconds. Another fast mixing technique has been developed for studies of the time scale of the oxygen effect in *Serratia marcescens*⁷. In these experiments the bacteria are mounted on Millipore™ filters fitted inside a chamber which is flushed with humidified nitrogen. The cells are exposed to an explosion of oxygen released into the chamber through a fast action solenoid-operated valve, either just before or just after irradiation of the bacteria with a single 2 microsecond pulse of electrons. The arrival of oxygen at the surface of the bacteria can be timed to occur at a preset interval before or after irradiation with a precision of ± 100 microseconds.

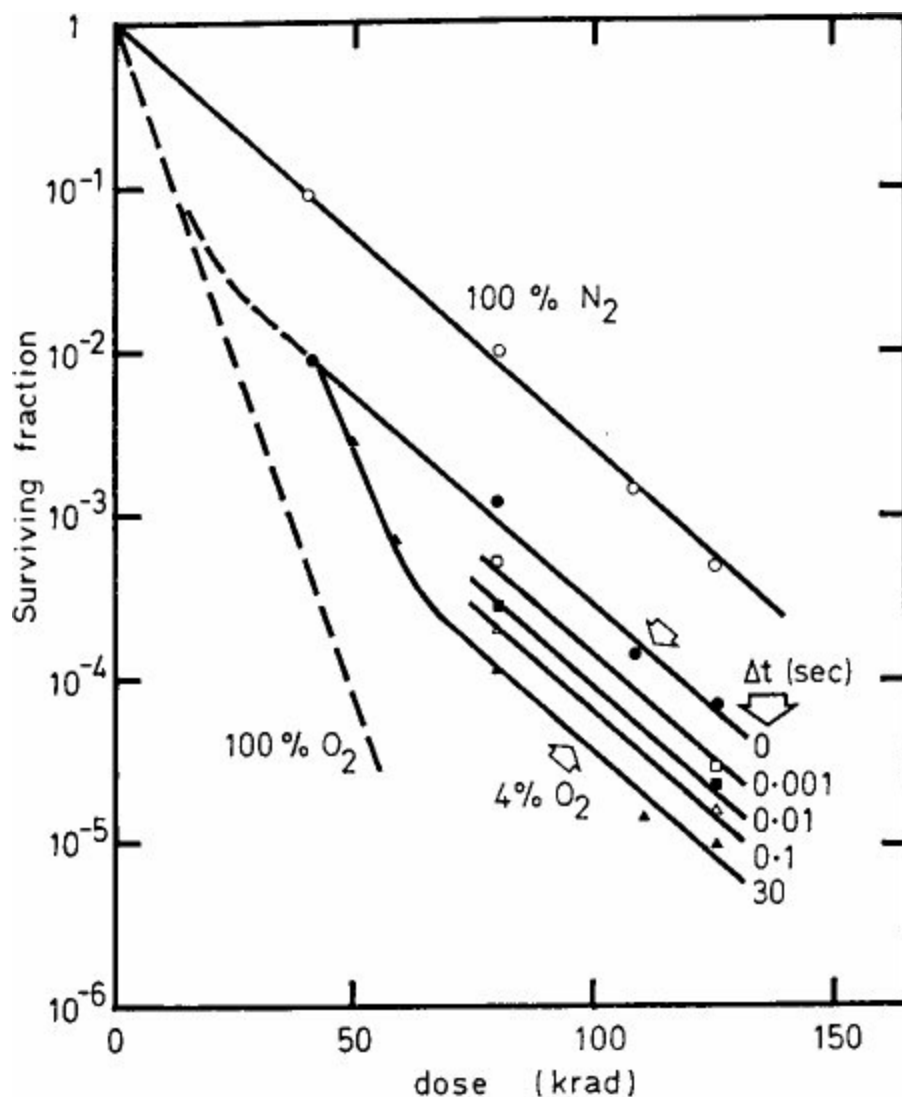

Figure 5. Radiosensitivity of *E. coli* B/r irradiated with two 3 ns pulses (dose rate $\sim 2 \times 10^{13}$ rad s^{-1}) separated by a varying interval Δt . Data from Epp *et al.* (ref. 5).

Some of the data obtained by this technique are shown in Figure 6. The surviving fractions of bacteria irradiated at three dose levels are plotted as a function of time interval between irradiation and exposure of the cells to oxygen.

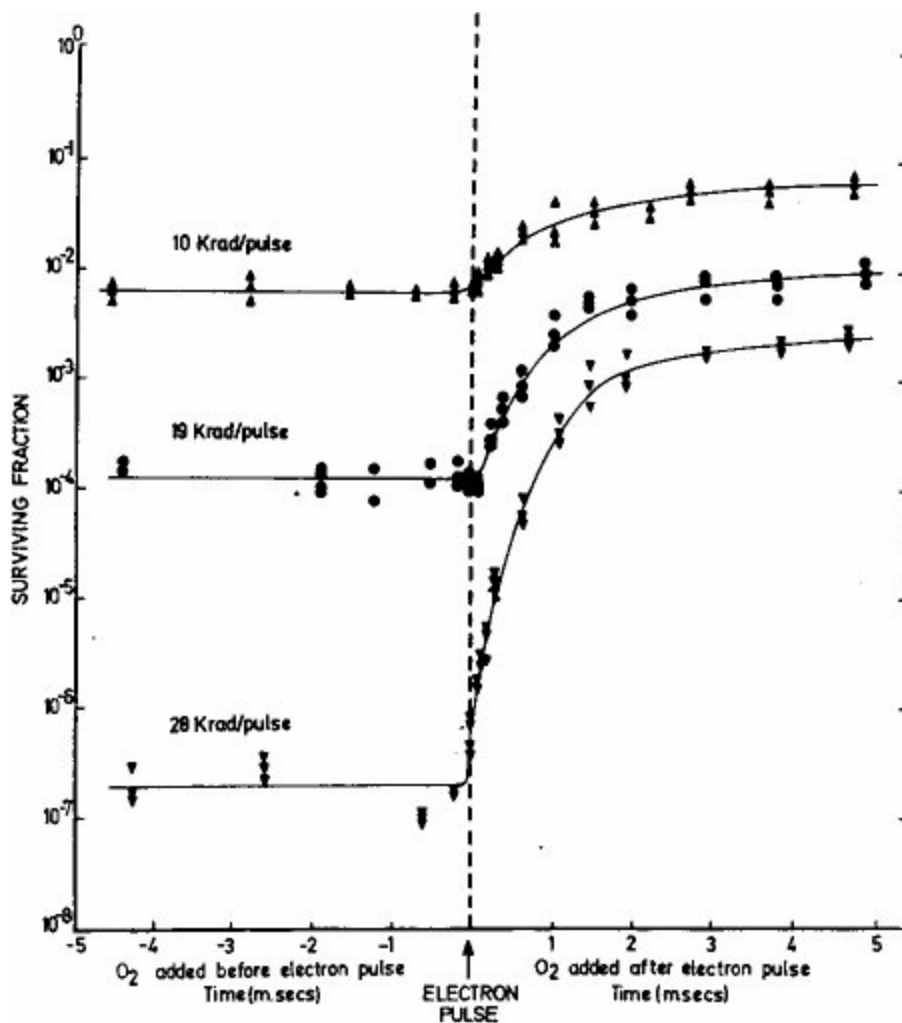

Figure 6. Radiosensitivity of *Serratia marcescens* irradiated with a single $2 \mu\text{s}$ pulse (dose rate $\sim 10^{10} \text{ rad s}^{-1}$) with oxygen added at varying intervals before or after the pulse. Data from Michael *et al.* (ref 7).

At each dose, when the bacteria are in contact with oxygen before irradiation even at the shortest resolvable time-interval of 100 microseconds, the survival level is the same as that found for normal oxidic irradiation in this apparatus (i.e. "infinite" contact time). However, when the oxygen contact occurs after irradiation, the surviving fraction increases over the time range 0-2 milliseconds. When contact occurs later than 2 milliseconds the level of survival is that normally observed for anoxic irradiation. The results indicate that, in this system, the damage which is sensitive to oxygen has a half-life of several hundred microseconds. This is somewhat larger than the life times derived by Epp and coworkers for *E. coli* B/r.

There is, however, an apparent discrepancy between the data with regard to the time scale for oxygen diffusion into bacteria. In the explosion experiments the sharpness of the rise in the survival fraction near zero time delay suggests that the time required for diffusion is much less than the half life of the oxygen-dependent damage, i.e. $\ll 5 \times 10^{-4}$ seconds. The data of Epp and co-workers show that a significant amount of oxygen can indeed diffuse to critical sites inside the cell in a time at least as short as 10^{-4} seconds, but diffusion is not complete until seconds after exposure.

The apparent discrepancy between the two sets of data regarding life times of oxygen dependent damage is not large and may be due to the use of different bacteria. The main point of difference is the oxygen diffusion time. Possible explanations lie in the different sizes of the two bacteria and the large difference in the concentrations of oxygen in the gaseous environment outside the cells. In the

explosion experiments several atmospheres of pure oxygen are used, whereas in the other system the oxygen concentration is only a few percent at normal pressure.

Epp's data suggest that, under the conditions used for sterilisation, the life time of the oxygen-dependent damage will be less than the diffusion time of oxygen. If this is universally true, then these life times are irrelevant to the efficiency of sterilisation. The only point of significance is whether oxygen can be replenished by diffusion at a rate which exceeds that of radiolytic consumption inside contaminating micro-organisms (see, for example, reference 8).

It is possible that at the dose rates used for sterilisation, the diffusion of oxygen into the contaminating organisms will not be fast enough to replace the oxygen consumed by radiolytic action. Under these conditions, the break point phenomenon will ultimately govern radiation response and the sterilisation efficiency will be diminished.

Dose rate and radiation repair

The radiation sensitivities of bacterial and mammalian cells are also affected by very low dose rate in the range of ten to several hundred rad per hour. These effects are generally due to repair processes which occur while the damage is accumulating. At even lower dose rates other effects may become apparent due to actual cell proliferation which may be occurring during irradiation. However, these effects are not observed at the dose rates used in sterilisation. Readers are referred to an excellent review⁹ for a complete discussion on the general dose-rate effects in radiobiology.

References

1. Hart, E. J. and Anbar, M. (1970). *The Hydrated Electron*, Wiley-Interscience, New York.
2. Thomas, J. K. and Hart, E. J. (1962). The radiolysis of aqueous solutions at high intensities. *Radiation Research*, **17**, 408-418.
3. Dewey, D. L. and Boag, J. W. (1959). Modification of the oxygen effect when bacteria are given large pulses of radiation. *Nature (London)*, **183**, 1450-1451.
4. Epp, E. R., Weiss, H. and Santomaso, A. (1968). The oxygen effect in bacterial cells irradiated with high intensity pulsed electrons. *Radiation Research*, **34**, 320-325.
5. Epp, E. R., Weiss, H., Kessar, N. D., Santomaso, A., Heslin, J. and Ling, C. C. (1973). Oxygen diffusion times in bacterial cells irradiated with high intensity pulsed electrons: new upper limit to the lifetime of oxygen-sensitive species suspected to be induced at critical sites in bacterial cells. *Radiation Research*, **54**, 171-180.
6. Kessar, N. D., Weiss, H. and Epp, E. R. (1973). Diffusion of oxygen in bacterial cells after exposure to high intensity pulsed electrons: theoretical model and comparison with experiment. *Radiation Research*, **54**, 181-191.
7. Michael, B. D., Adams, G. E., Hewitt, H. B., Jones, W. B. G. and Watts, M. E. (1973). A post-effect of oxygen in irradiated bacteria: a submillisecond fast mixing study. *Radiation Research*, **54**, 239-251.
8. Boag, J. W. (1969). Oxygen diffusion and oxygen depletion problems in radiobiology, in *Current Topics in Radiation Research*, ed. Ebert, M. and Howard, A., North Holland, Amsterdam, pp. 141-195.
9. Hall, E. J. (1972). Radiation dose rate: a factor of importance in radiobiology and radiotherapy. *Brit. J. Radiology*, **45**, 81-97.

Panel

Questions and Answers

To W. L. McLAUGHLIN — USA, and I. G. DRAGANIC — Yugoslavia, by: A. E. CHAPIRO — France

I feel that any chemical system liquid or solid can be used profitably for dosimetry provided its response to dose follows simple relationships with respect to dose rate, environment etc., and its stability, i.e. reasonable stability before and after irradiation. I, therefore, consider that existing

Q. dosimeters cover the needs of potential users to a large extent. The handling techniques for most systems of interest can be acquired after a few weeks experience. I think some of us would feel very strongly that life, is not quite so simple. Would Dr. McLaughlin or Dr. Draganić like to tackle that one first?

A. W. L. McLAUGHLIN — I don't agree entirely. In fact, I think some of your compatriots, particularly the people developing the new tetrazolium hydrochloride dosimeter would disagree strongly because they feel, and I am beginning to agree with them, that they have very promising dosimeters; one that does meet the parameters that you mention, dose rate, environment, and so forth. The temperature dependence is less than existing systems and therefore, I'd hate to see research on new systems discouraged in spite of the fact that practically every laboratory uses a different system for the very reasons that you give. They have their own systems, they have spent a month or more learning to use it and their technicians are used to it. But we still have hopes for a panacea.

A. I. G. DRAGANIĆ — I think I have nothing to add to what has been said this morning and this afternoon.

Comment by Moderator:

I think I would like to take Moderator's privilege and point out that the repeatability of any systems, even within one laboratory is not gained in weeks, but in months and often in years. It's the habit of working skills of a working lifetime.

To K. H. CHADWICK — The Netherlands, by: W. A. JENNINGS — England, S. C. ELLIS — England, N. W. HOLM — Denmark — W. L. McLAUGHLIN — USA

We believe that your intercomparison example was badly chosen in that it grossly misrepresents what can be and is achieved in comparison among experienced institutes. We have had no difficulty in achieving agreements between our institutes, to better than 1% for chemical

Q. dosimetry. More relevant examples are also available from the experience of the American National Bureau of Standards, and the International Atomic Energy Agency. Would you comment please?

A. The intercomparison was shown only to indicate the benefits which can be obtained in the exercise. In the second intercomparison all the institutes were closer to the normalization level and to each other. Many of the institutes taking part in the intercomparison illustrated are very experienced and have an international reputation in their field. I think that I would expect an intercomparison between NBS, NPL and Risø on chemical dosimetry should agree at a 1% level and I don't expect, a priori, that an intercomparison at a Mrad level in radiation sterilization would necessarily give a poor result. I feel that the benefits to be gained make the exercise worthwhile.

Comments by Moderator:

I think I must point out in deference to Dr. Holm's reply, that the Risø group did not participate in this particular intercomparison. My laboratory did. We're one of the good ones with a small error. I might say by comparison that what Dr. Chadwick pointed out was in radiotherapy which is really the ideal model. I think I must agree with the questioners, it is not the best model for what is happening in megarads dosimetry.

To W. L. McLAUGHLIN — USA, by: Z. P. ZAGÓRSKI — Poland

Q. Very little was said, in fact nothing, about the application of solid dosimeters. We have done some work on solving difficult dosimetric problems like dose distribution inside a needle, in the shadow of it, etc. These are not published yet. Would you comment — which solid dosimeters qualify, due to their proper atomic number etc. for the particular dosimetric problems, especially for dose distribution in heterogeneous systems?

A. W. L. McLAUGHLIN — Well, I don't agree that we did not talk about it at all. But, I'll expand on what I said earlier that it is possible to measure dose close to an added interface and as for the question from Dr. Zagórski, about the measurement of dose inside such a tiny object as a needle, I'm sure the work both theoretical and experimental on the measurement of dose in bone trabecula may be applied to those measurements inside a needle. I believe powder or solutions of thermoluminescent materials were used and it doesn't matter what dose, total doses, are used.

There are calculations at the National Bureau of Standards which have been using Monte Carlo calculations of the dose distribution at interfaces of different materials. That program is available to everybody simply by writing to Oak Ridge. We made measurements using radiochromic dye systems plus an interface of aluminum and gold. Interfaces of carbon and gold and plastic and gold, meaning different atomic number systems, were made also and it was found that the measurements were fairly close to those given by the theoretical calculations. However, stopping power corrections had to be made right up to the interface so that the dose in that material is

represented faithfully. Now how close to an interface as small as a needle can be actually measured by this technique, I wouldn't like to say. Does that answer your question?

Comment by Moderator:

Can I put a supplement on that. Would you like to put a confidence limit on the kind of doses that you're going to be able to measure close to interfaces, 10% - 20% - 50%?

A. by W. L. McLAUGHLIN — Well, I would put a 5% limit on the values close to an interface.

To K. H. CHADWICK — The Netherlands, by: T. A. OLEJNIK — USA

Q. Is the use of bulk density for calculating absorbed dose strictly valid when indeed medical products are often composed of materials of greatly varying densities?

A. In radiation sterilization in a bulk irradiator we are interested in the maximum dose and the minimum dose in the product. In general in an isotope irradiator the maximum dose will be in the outside plane of the product, the minimum dose will be in the central plane of the product. I think that bulk density can be used to give a good indication of expected dose levels. However, it is wise to be aware of, and to be prepared to measure, local variations in dose distribution in areas of inhomogeneous density in the product box.

A second problem is that of interface dosimetry at for instance metal-air or metal-plastic interfaces at the position of minimum dose. One very difficult dosimetric problem is the measurement of dose at the metal-air interface in a hypodermic needle for instance.

Comment to

B. D. MICHAEL — England, by: N. W. HOLM — Denmark

You stated in your presentation this morning that dose rate effects caused by spur overlap occurred at dose rates of approximately 10^9 rads/sec in the pulse and you concluded that these particular dose rate effects were thus beyond the scope of this meeting. It should perhaps be mentioned that at least four European electron linear accelerators* are doing medical sterilization work at or above 10^9 rad/sec in the pulse under scanned beam conditions, and that spur overlap dose-rate-effects are clearly indicated from chemical as well as biological investigations.

Comment by

B. D. MICHAEL — England

You have drawn attention to what must have been a slip of the tongue. I had meant to say that spur overlap only becomes probable at doses above about 10^9 rads/sec. This dose range is much higher than the doses with which this meeting is concerned.

Q. Since radical-radical and oxygen scavenging reactions are implicated in dose-rate effects, which will dominate at a high dose rate? Which time scales are the most important? Is it the length of the microwave period or the interpulse period?

A. I think that the answer to the first part of your question was really covered in Dr. Adams' paper. The radiolytic consumption of oxygen is a dose effect and proceeds with about the same efficiency over a wide range of dose rates. Dose rate only becomes significant when consumption and re-oxygenation by diffusion are competing with each other. When diffusion is relatively slow all the molecular oxygen is usually removed by the first few tens or hundreds of kilorads in most aqueous systems and plastics; under these conditions radical-radical reactions may become more significant than radical-oxygen reactions, provided the dose rate is sufficiently high. In answer to the second part of your question, where I believe you are mainly concerned with microwave linac beams, I think that the microwave fine structure is generally of no significance in high dose rate effects in dosimeters. For example, in both ionization and chemical solution dosimeters the important quantities are the micro-second pulse duration and the interpulse interval.

To G. E. ADAMS — England, by: S. V. NABLO — USA

Q. It seems to me that you omitted a very critical aspect of rate effect in your presentation; namely, the rapid decrease in "chemical" efficacy of radiation with increasing delivery rate. Those of us working with "high rate" that is greater than 10^{10} rads/sec machinery, such as the ELIT Type transformer accelerator, see this as a crucial aspect of radiation sterilization. Would you like to comment?

A. I only touched on this briefly with my comments on the use of the 'Super-Fricke' dosimeter. Here, the effect of radical-radical reactions being suppressed by increasing the solute concentrations, illustrates how the decrease in 'chemical efficacy' can be prevented.

At the dose-rates you mention, it is possible that in some chemical systems, radical concentrations may build up to levels approaching those in spurs. Radical-radical interactions will occur and the overall effects will be similar to the changes observed at high LET.

To G. E. ADAMS — England, by: H. B. RAINEY — New Zealand

Q. Is there any evidence to support any change in radiation sensitivity to microorganisms occurring over the last 10-15 years, assuming similar condition of irradiation? Is there any theoretical evidence why this should not be so?

A. I know of no theoretical reason why this should be so. Selection of radio-resistant mutants can occur in an irradiated population but I see no reason why there should be any change of radiosensitivity in all populations of microorganisms.

To W. L. McLAUGHLIN — USA, by: S. V. NABLO — USA

For many commercial applications, the flexibility of thermoluminescent dosimeters is attractive. Could you tell us what is being done to improve their dynamic range? Can one tailor their

Q. properties by implantation doping for example, and come up with a TLD with useful range to 10^7 rads and compatible with existing readout systems?

A. That's an inviting prospect and I think it has certainly been tried. I know that calcium fluoride-lithium borate has been impregnated into Teflon™ and other plastics but I don't know of any success in making its range that much higher successfully. If anyone else in the audience knows, let them speak now.

Comment By:

I. DRAGANIĆ — Yugoslavia

My comment is not to give you information that these things have succeeded but what I wish to tell is a kind of continuation of what I said in connection with large dose chemical dosimeters, where all kinds of troubles and discrepancies have occurred. By pure and theoretical approaches, trying a little harder way, but the right way, to understand the reaction mechanisms; to try to catch it and control it, and then to do what we wish. I think all this is much more true for TLD, because everything we tried is more or less black magic. I don't know how to find proper comparison to the various improvements one gets. They are not very reliable and certainly they're not predictable. So it can happen that in millions of various approaches, one will succeed in getting 10^6 or 10^7 rads dose range. I think it's not the right way. I think we need a much better understanding of what is going on and then we should try to extend the range.

Comment by:

B. D. MICHAEL — England

I'm afraid I just can't remember the reference to the work but I have seen a reference to extending the range of lithium fluoride, I think, to 10^7 rads and this involved reading out to a much higher temperature than usual. I think it was as high as 450 degree centigrades. Maybe some expert in the audience is familiar with this.

Comment from the Audience:

The work I think is Peter Almond's group, but I believe there is some problem with that.

To G. E. ADAMS — England, by: N. W. HOLM — Denmark

You demonstrated in a very fine way that oxygen depletion leads to effects which are governed by total dose rather than by dose rate. This is certainly correct. But I fail to see how your line of

Q. argument can rule out that this total dose effect is superimposed upon a true dose rate effect. In a cell containing 75% water and a dose rate of 10^9 to 10^{10} rads per second in the pulse, as you can have in a center of a beam spot in a scanned linac beam, I would feel that you can expect a true dose rate effect. Perhaps, as high as 10 to 15% in terms of lethal efficiency. Would you care to comment?

A. First of all, there was no, a priori, reasons why one should expect a dose rate effect as far as organisms are concerned at that dose rate. I guess your question is basically concerned with what may be a difference in efficiency between linac beams and cobalt irradiation. Certainly oxygen depletion does give an apparent dose rate effect, but let's remove that and let's look at the response of an organism. To the best of my knowledge where people have made a comparison between the anoxic response of solid materials irradiated at low dose rates with X-rays or gamma rays compared with very high dose rates from pulses as high as 10^{15} rads/sec, there is no detectable change in the absolute radio-sensitivity in nitrogen. Now, in oxygen, the variations that you experience may well change the level of oxygen depletion, at least down to the level of radio-biological anoxia. Then a periodic variation in dose rate that you would get with a scanned linac beam could very well affect the marginal level of oxygen depletion which may be near the level of radiobiological transformation. And for those reasons, I still would put my money on this; it's a dose rate effect and the research on anoxic systems suggests that there is no difference between the efficiency of inactivation by high intensity electrons compared with low intensity gamma rays.

Additional Comment by:

G. E. ADAMS — England

Well, I apologize for coming back but I would like to make two points. First, that we are involved in something of a semantic discussion which is caused by the thing that in irradiation chemistry a dose rate effect is defined strictly by a radical-radical recombination. Many other people feel when you are irradiating with high intensities that this goes for dose rate effects too. I fully agree as I said that you have a total dose effect caused by oxygen depletion, but there is one thing that is still strange to me. I'm certainly not going to deny the results at the extreme dose rate you described. I'm just putting a very slight question mark. Now in our chemical dosimeters, we do have dose rate effects under the beam condition I'm describing when you have a vegetative bacteria with a water content of about 75%. You would imagine that the lethal effect could be caused by a combination of direct hits, the good old target theory, and indirect effects through radiation chemistry. This is why I keep coming back to the idea that how can you rule out that this indirect effect could play a fairly significant role and the reason I do it, of course, is that we see constantly in intercomparisons that there is a difference in efficiency. I agree, it is partly, and perhaps almost fully, explained by the oxygen depletion which certainly takes place. I just want to keep that option open.

Anonymous Comment:

It's well taken. The reason why I use the anoxic situation for making a comparison is that there is no problem of oxygen depletion, and if in a biological system dose rate effects are observable, they are

confined to an oxygenated system experimentally. Not so with an anoxic system. And, it is certainly true that dose rate effects in a chemical system can be manifested in this region and change quite acutely, with relatively small changes in dose rate. As I turn the question around the other way, I tend to share the opinion that the very absence of dose rate effects in anoxic cellular systems makes me think that direct processes are much the more important in inactivation than anything associated with the radiolysis of any of the type with water.

To W. L. McLAUGHLIN — USA, by: W. BRADBURY — USA

Q. What dose read out variability can you expect with cobalt-60 dose rates ranging from say 4 megarads an hour down to 0.1 megarad per hour when red Perspex™ systems are used?

A. The last chart I showed during my paper showed some bar graphs. One of those covered red Perspex™. The dose rates for cobalt-60 were about in this range and the first electron beam dose rates were much higher than this range. There was no variation in response over these dose rates but when you go above an average of about 10^8 rads/sec, red Perspex™ begin to show a loss in response. I believe this differs a little from a statement Dr. Michaels made this morning. My ear pricked up when you said something different from that.

Comment by:

B. D. MICHAEL — England

My statement is based really on the use of red Perspex™ dosimetry from spore inactivation work that Dr. Tallentire has been doing with us at the Gray Laboratory. His dosimetry using red Perspex™ at about a dose rate that is something of the order of 10^{15} rads/sec gave virtually the same within a matter of a few per cent of the results that we obtained using spores at the same dose rate. The dosage there was measured by calorimetry with this rather indirect system of reference from calorimetry to red Perspex™. I concluded that there is no very great departure of response in the red Perspex™.

To W. L. McLAUGHLIN — USA, by: G. PRÖPSTL — Belgium

Q. Could you give detailed indications about the composition of the radiochromic dye cyanides.

A. I've often recited poems, but never to more than one person at a time in which I said: "Do I love thee, let me count the ways". There are so many ways that this system can be made up that I'd hate to begin reciting. There must be 50 different combinations, each having a different dose range or a different application, but the one that is sold is a thin nylon film or as polychlorostyrene films. I think perhaps I better talk to the questioner afterwards.

To K. H. CHADWICK — The Netherlands, by: I. LERCH — Austria

You suggest that an international intercomparison of sterilization facilities would be a *good thing*.

Q. Who should do it? Who should participate? Who would provide the standardizing facility? What detector should be used? etc.

A. I really believe an intercomparison at the Mrad level to be a good thing. It seems obvious to me that international organizations such as IAEA and EEC, should be involved. The national standard laboratories also have to be involved in providing the standards. Some secondary standard laboratories could also be involved. Everyone who is interested should take part and a series of detectors should be used together. To summarize, I don't think one person or organization can do this work, I think a coordinated effort with different comparable systems is required.

-
- * 1. CAPRI — France
 - 2. IBT — Poland
 - 3. RADEST — Denmark
 - 4. Risø — Denmark

General Discussion

Biological dosimetry based on measurement by electron spin resonance technique (ESR) the radiation induced defects in the crystalline fraction of bone mineral.

K. Ostrowski

Department of Histology and Embryology, Institute of Biostructure, Medical School, Warsaw, Poland.

In shortest words the basis of “spin dosimetry” will be presented. The idea of this kind of dosimetry is a by-product of the activity of the tissue bank in Warsaw. The work is done in collaboration with the Dept. of Radiation Chemistry of the Institute of Radiation Research in Warsaw. The co-authors of this report are Dr. A. Dziedzic-Goclawska MD, Dr. W. Stachowicz PhD and Dr. J. Michalik BSc.

When bone is irradiated by gamma radiation from the ^{60}Co source for sterilization purposes, large amounts and a variety of free radicals and other paramagnetic species appear in the bone tissue. If bone is stored at room temperature in air all of them disappear except one (Figure 1). This asymmetric singlet is stable and does not change in slope and concentration in bone for years.

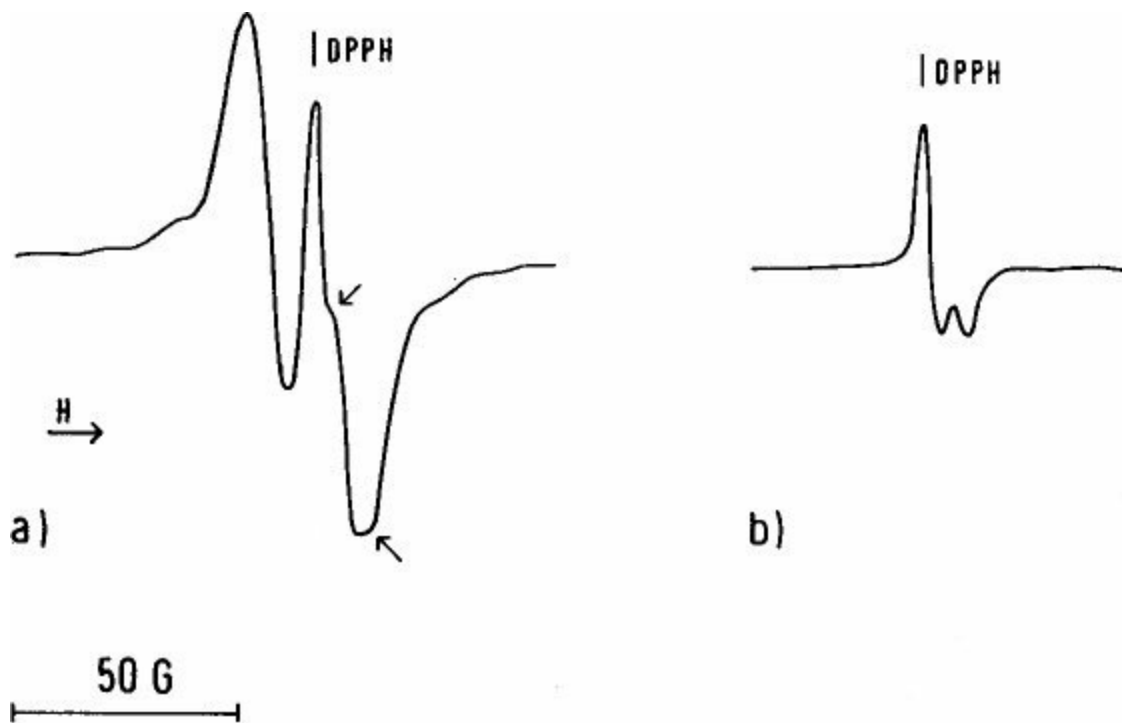

Figure 1. This figure shows the transformation of the complex EPR signal
 (a) derived from bone irradiated in vacuo into simple asymmetric singlet
 (b) after storing at room temperature in air.

It was proved that this stable ESR signal is connected with radiation induced defects in the crystalline lattice of hydroxyapatite. We are using this signal as a new kind of label of biological material. It is used for quantitative evaluation of the kinetics of bone graft resorption, creeping substitution, new bone formation or induction of heterotopic osteogenesis.

This asymmetric singlet is also used for estimation of crystallinity of tissues because it is connected with the crystalline fraction of tissue mineral and not with the amorphous or "submicro-crystalline" one. Crystallinity of pathologically mineralized tissue can be also measured by this method. As these problems are out of the scope of this conference, I will not discuss them any longer.

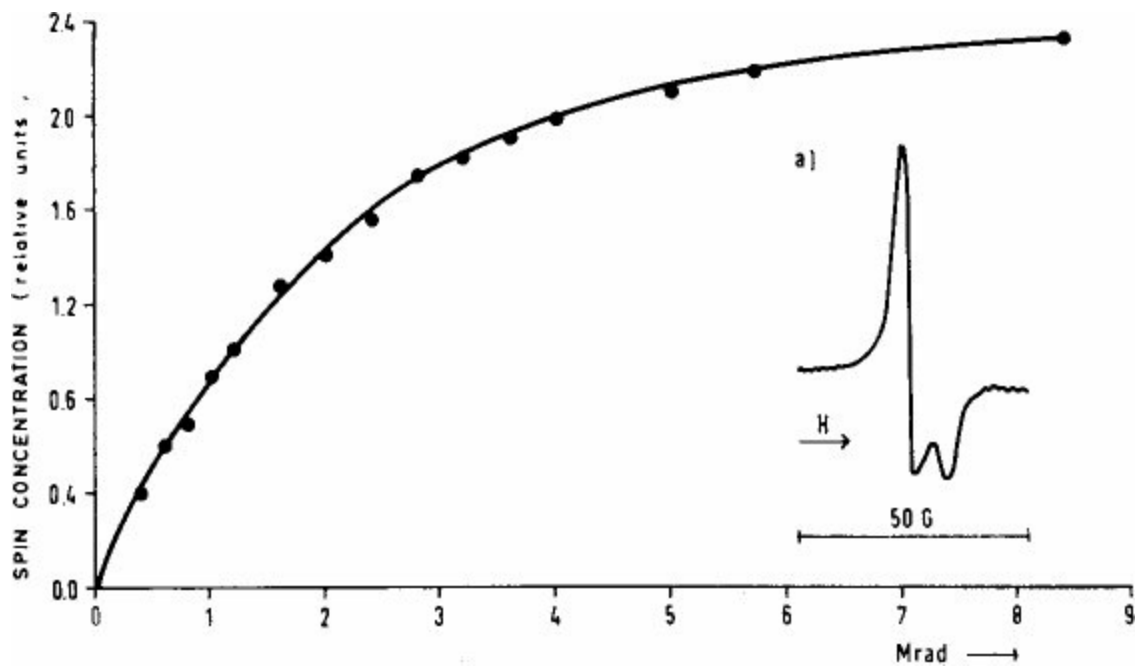

Figure 2. The dose dependence curve. The measured spin concentration concerns the asymmetric singlet (a).

On the Figure 2 the dose dependence curve is shown. For the research mentioned before, i.e. for kinetics of rebuilding of bone tissue or for calculation of crystallinity of tissues the saturating dose of irradiation, higher than 3.5 MeV is used. On the other hand the linear relation between the applied dose of irradiation and the concentration of spins in bone tissue can be observed in the range reaching 2.0 MeV. This part of the curve can be used therefore as a biological dosimeter and bone tissue may serve as an indication, after irradiation *in vitro* and *in vivo*.

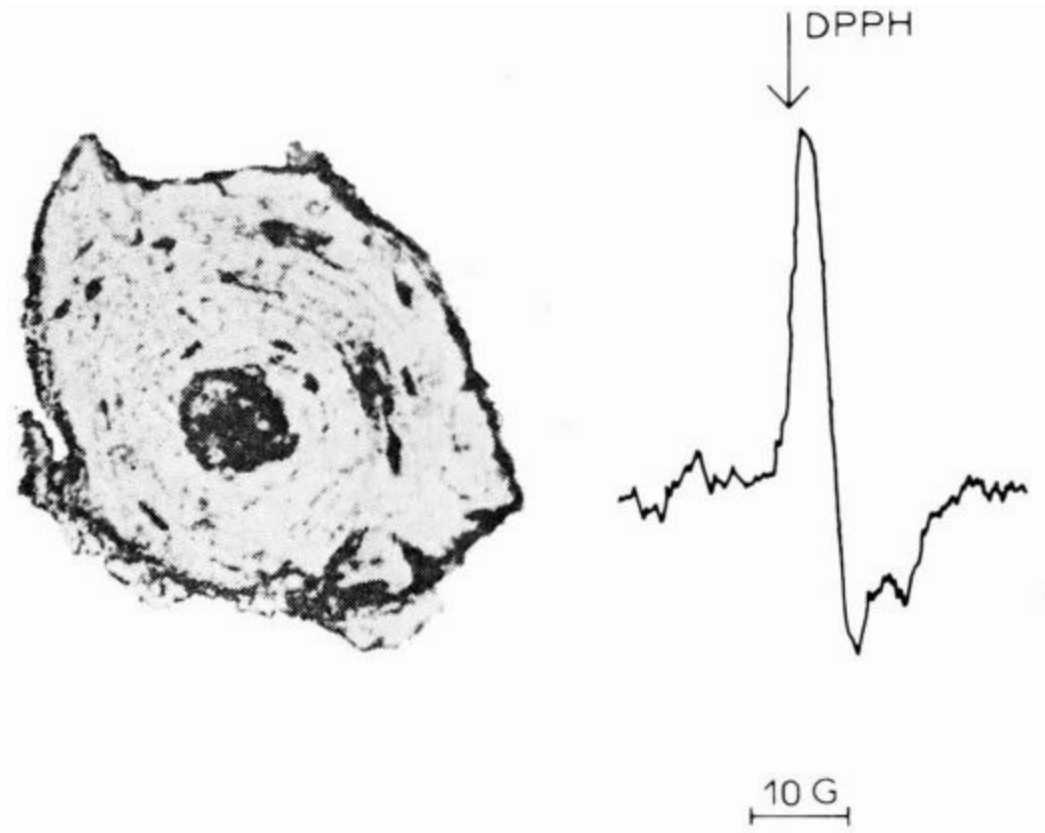

Figure 3. Single osteon isolated from the undecalcified 100 micron thick section and 1st EPR signal showing high signal to noise ratio.

Single user license provided by AAMI. Further copying, networking, and distribution prohibited.

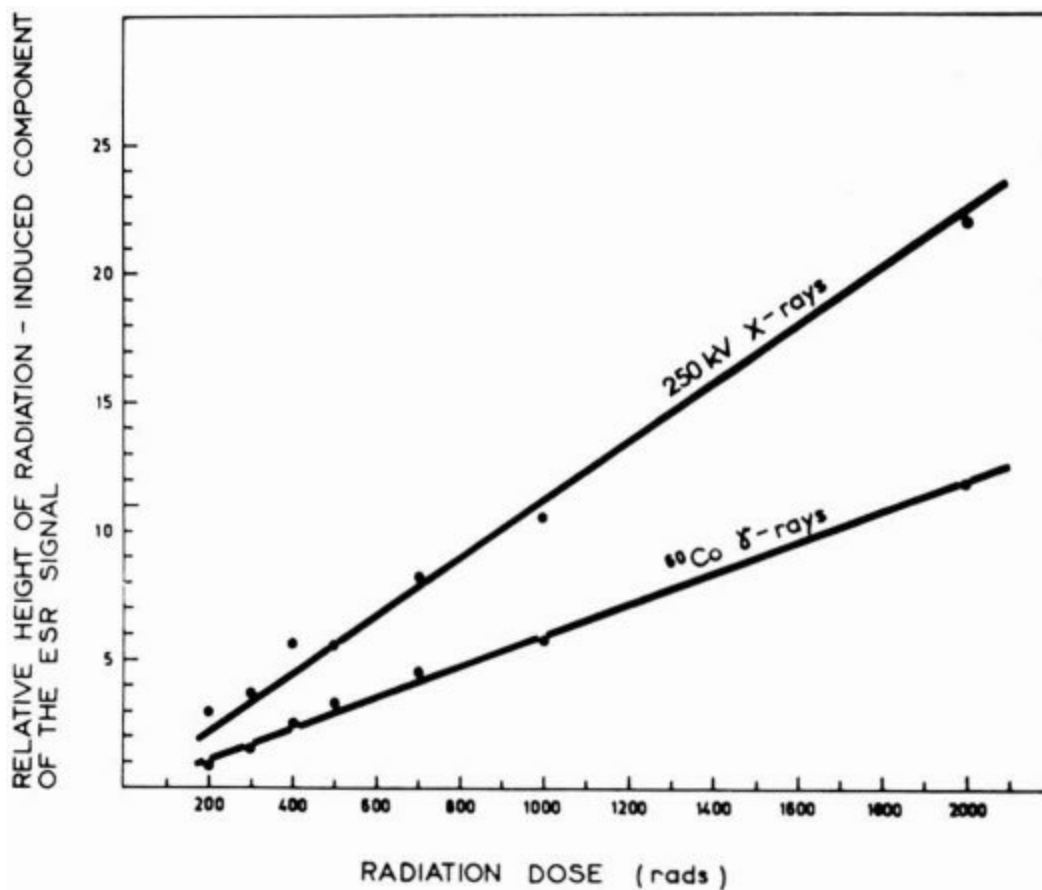

Figure 4. The comparison of two dose dependence curves differing in the angles of their slopes. The difference is connected with the difference in LET values of ^{60}Co gamma rays and 250 kV X-rays.

I have no time to go into detailed discussion on accuracy and sensitivity of the method. One example can be given to illustrate the amount of tissue needed for measurements. Figure 3 shows single osteon (Haversian system) isolated from 100 micron thick undecalcified section, weighing less than 0.1 mg. After irradiating by saturating dose the signal to noise ratio which is found in the sample is high enough for comfortable computations.

Figure 4 shows two dose dependence curves. They differ in the angles of their slopes because of the differences of LET values of gamma radiation from ^{60}Co source and 250 kV X-rays. The lowest doses which could be measured by the discussed "spin dosimeter" are in the range of 200 rads when bone is used and 50 rads when tooth enamel is applied as detector.

The detailed discussion of the above mentioned problems is published in the papers listed below.

References

1. Dzedzic-Goclawska, A., Wlodarski, K., Stachowicz, W., Michalik, J. and Ostrowski, K. Quantitative evaluation of the rate of mineralization of induced skeletal tissue by the electron spin resonance technique, *Experientia* **27**, 1405, 1971.
2. Gordy, W., Ard, W. B. and Shields, H. Microwave spectroscopy of biological substances. I. Paramagnetic resonance of X-irradiated amino acids and proteins, *Proc. Nat. Acad. Sci.* **41**, 983, 1955.
3. Houben, J. L. Free radicals produced by ionizing radiation in bone and its constituents, *Int. J. Radiat. Biol.* **20**, 373, 1971.
4. Ostrowski, K., Dzedzic-Goclawska, A., Stachowicz, W. and Michalik, J. Application of electron spin resonance in research on mineralized tissue, *Clin. Orth. Rel. Res.* **97**, 213, 1973.
5. Ostrowski, K., Dzedzic-Goclawska, A., Michalik, J. and Stachowicz, W. Quantitative evaluation of irradiated bone grafts resorption rate by the electron spin resonance technique. *Experientia* **26**, 822, 1970.
6. Ostrowski, K., Dzedzic-Goclawska, A., Stachowicz, W., Michalik, J., Tarsoly, E. and Komender, A. Application of the electron spin resonance technique for quantitative evaluation of the resorption rate of irradiated bone grafts, *Calcif. Tissue Res.* **7**, 58, 1971.

7. Ostrowski, K., Dziedzic Goclawska, A., Stachowicz, W. and Michalik, J., Sensitivity of the electron spin resonance technique as applied in histochemical research on normal and pathological calcified tissue, *Histochemie* **32**, 343, 1972.
8. Stachowicz, W., Ostrowski, K., Dziedzic-Goclawska, A. and Komender, A. ESR study of bone tissue sterilized by gamma irradiation, *Nukleonika* **15**, 131, 1970.
9. Swartz, H. M. Long-lived electron spin resonance in rats irradiated at room temperature, *Radiat. Res.* **24**, 579, 1965.

Using semiconductors for measurement of high energy gamma radiation

V. Stenger

*Institute of Isotopes, Hungary Academy of Sciences, H-1525 Budapest 114,
P.O.B. 77, Hungary.*

The home-finished semiconductor detectors have been applied in the Institute of Isotopes of the Hungarian Academy of Sciences for measurement of high gamma-dose rates since 1968¹. The current induced by the gamma-radiation in the semiconductor was measured by a galvanometer of a sensitivity of 10^{-9} A per one unit of the scale². It was found that the silicon diode chosen was linear within $\pm 5\%$ in the dose rate range between 10^2 and 10^7 R/h (reference 3). Eventual radiation damage caused by high dose was investigated, as well as the decreasing of the signal at the detectors as a function of the temperature. It was stated that p-type semiconductors are more radiation resistant than n-type⁷. The direction dependence of our detectors could be compensated⁶.

After these qualifying measurements we have drawn the conclusion that semiconductor dose rate detectors applied in short-circuit mode of operation possess unique advantages. These are as follows:

1. They are independent of main voltage.
2. They have linear response within a minimum of 5 orders of magnitude in medium dose rate ranges (10^2 - 10^7 R/h) their linearity is very good throughout the total range.
3. Since the signal induced by a dose rate as high as 1 MR/h, is only a few mV, no insulation problems arise with the connecting leads which represents a great advantage in the case of underwater measurements.
4. The resistance of the connecting leads is negligible as compared with the internal resistance of the instrument and the semiconductor, thus measurements may be carried out in distances up to 100 m from the radiation source.
5. The very small size of the detector permits to follow very fine variations.
6. The detector is a commercial product and its price is low and its application is also inexpensive.

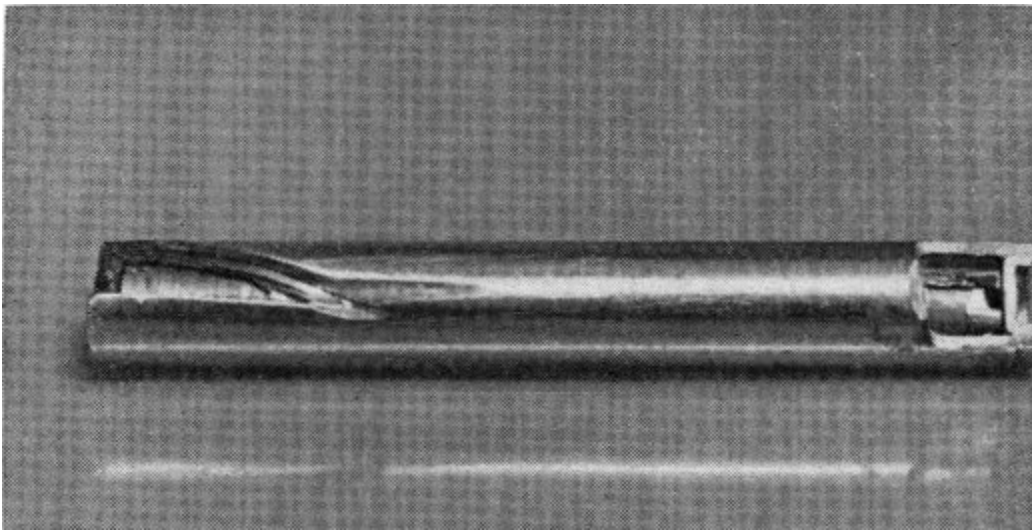

Figure 1. The VII. type of source elements.

Some typical examples of application will be shown in the following part:

The p-n layer of a power diode used in a short-current operation method was first studied for underwater measurements. The relative activity of radiation sources supplied for the Institute was checked. The linearity of the silicon diode was checked using radiation source rods of the following dimensions: diameter 11.5 mm, height 81.5 mm (Figure 1). The activity of the 80 pieces of radiation sources was between 1110 and 1280 Ci. This control was necessary to realize the planned recharge of the radiation source². The sensitivity of our method permitted us to carry out the recharge in a way ensuring maximum dose homogeneity by selecting optimum position for each rod⁴.

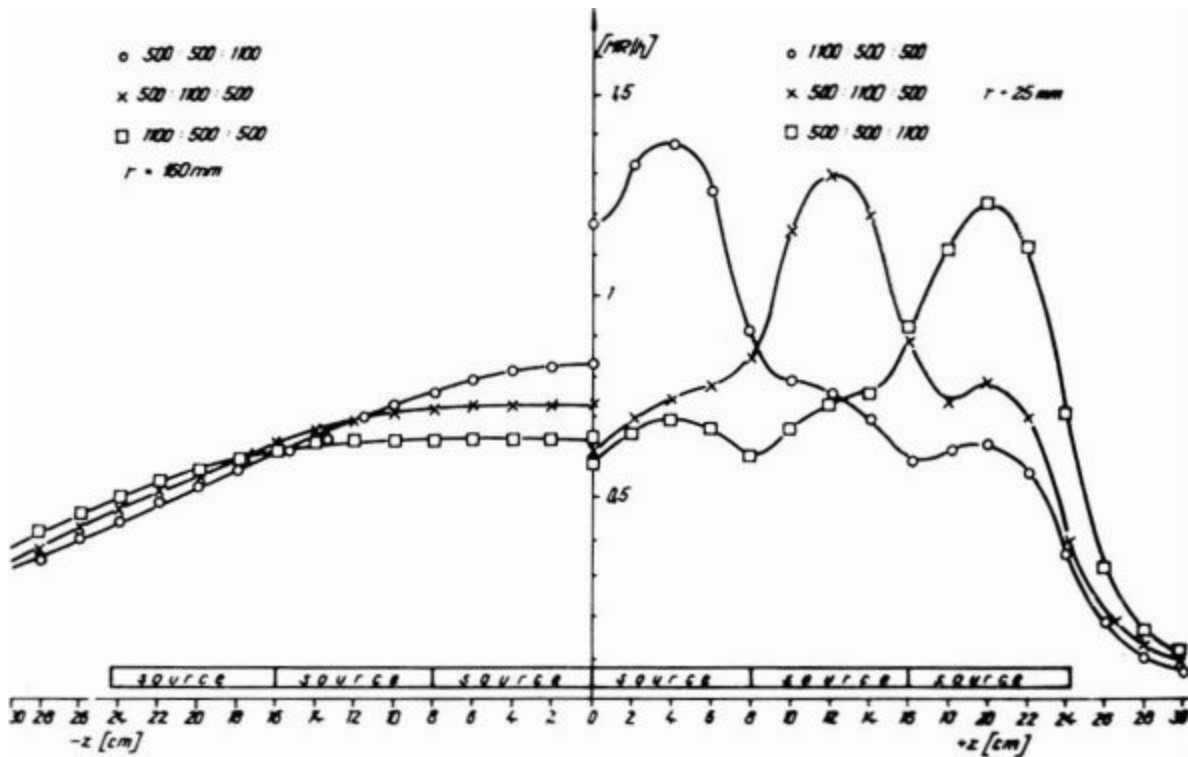

Figure 2. The calculated dose rate curves of a "six element" source rod.

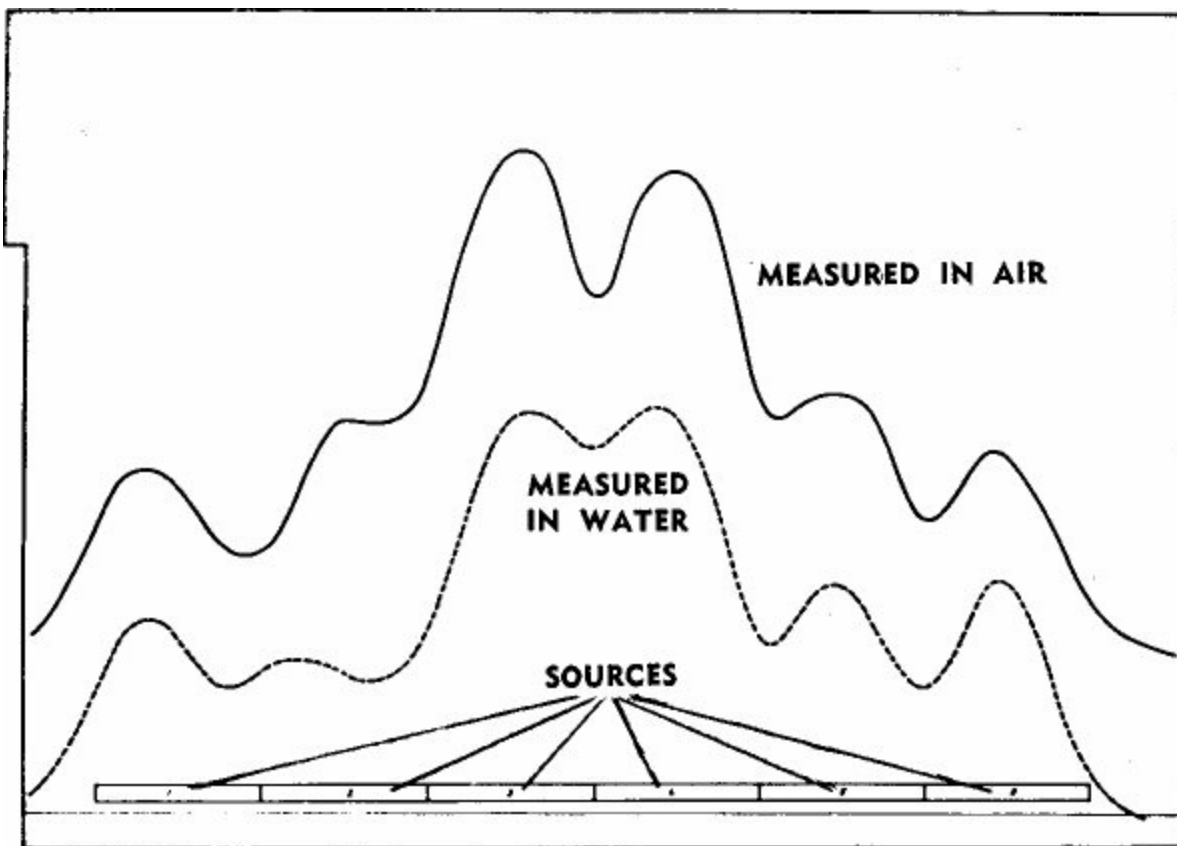

Figure 3. The controlled dose rates curves of the "six element" source rod.

After this, the dose distribution in the 32 cubic meter irradiation chamber of the 80 kCi irradiation facility had to be determined⁵. The system was calibrated by means of chemical and other standard dosimeters at selected reference dose rates values⁶. Thus, a very rapid measuring tool was obtained.

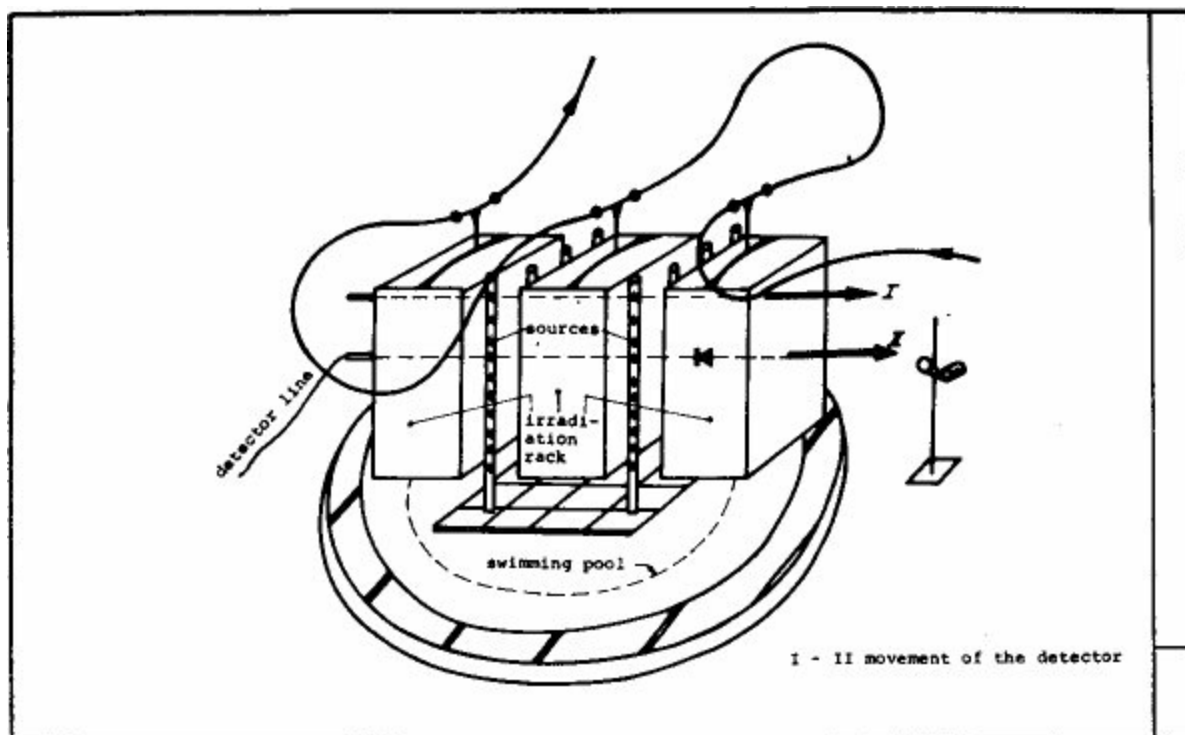

Figure 4. The geometry arrangement of the food irradiation plant.

If the geometry of source arrangement does not permit the development of a computer programme

in order to determine the dose distribution in space with a planned geometry, a rapid measurement can be carried out with semiconductor detectors immediately after charging or even after charging only a part of the sources to determine the actual dose rate distribution.

The recharge of our 80 kCi irradiation facility represented also a task of considerable interest. A computer optimization was made for this charging prior to operation (Figure 2). The optimum data given by the computer were checked by our semiconductor detector (Figure 3). New dose data were available within two days. The computer-made dose rate chart included 120,000 pieces of data.

A suspension rail conveyor was built to complete an experimental food irradiation plant of 60,000 Ci activity, in the Central Food Research Institute in Hungary⁸ (Figure 4). Instead of the earlier static irradiation, both static and continuous irradiations were planned, and the dose distribution had to be optimized for both types of operation. The planned vertical arrangement of radiation sources was realized in an underwater storage tank, the dose distribution was monitored by semiconductor detectors and, as a result, a nearly ideal distribution could be realized.

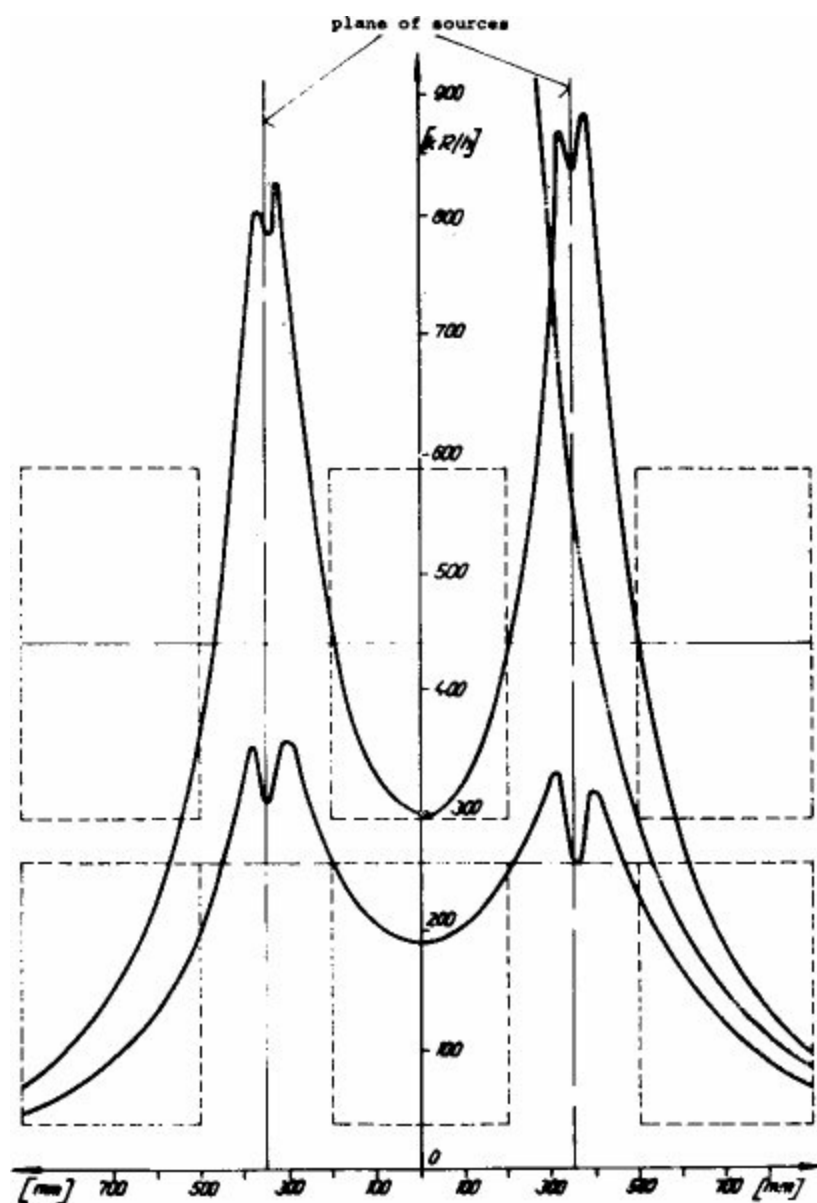

Figure 5. Dose rate distribution along two horizontal axes of the food irradiation plant.

Distribution was determined along two horizontal axes (Figure 5). Within two hours after charging, the following basic characteristics of the facility could be determined:

- a) dose ratio, over dose ratio,
- b) performance,
- c) production per year,
- d) reference positions for dose monitoring,
- e) possibilities of further modifications.

Next, a dose rate distribution determined in a Mark RH-gamma-30 Soviet made container-type irradiation facility is shown. The detector was moved along the predetermined line (Figure 6). This was realized by means of the recorder instrument itself; the detector was connected with the chart driver using a wire. The figure shows absorption of water in the irradiation vessel too.

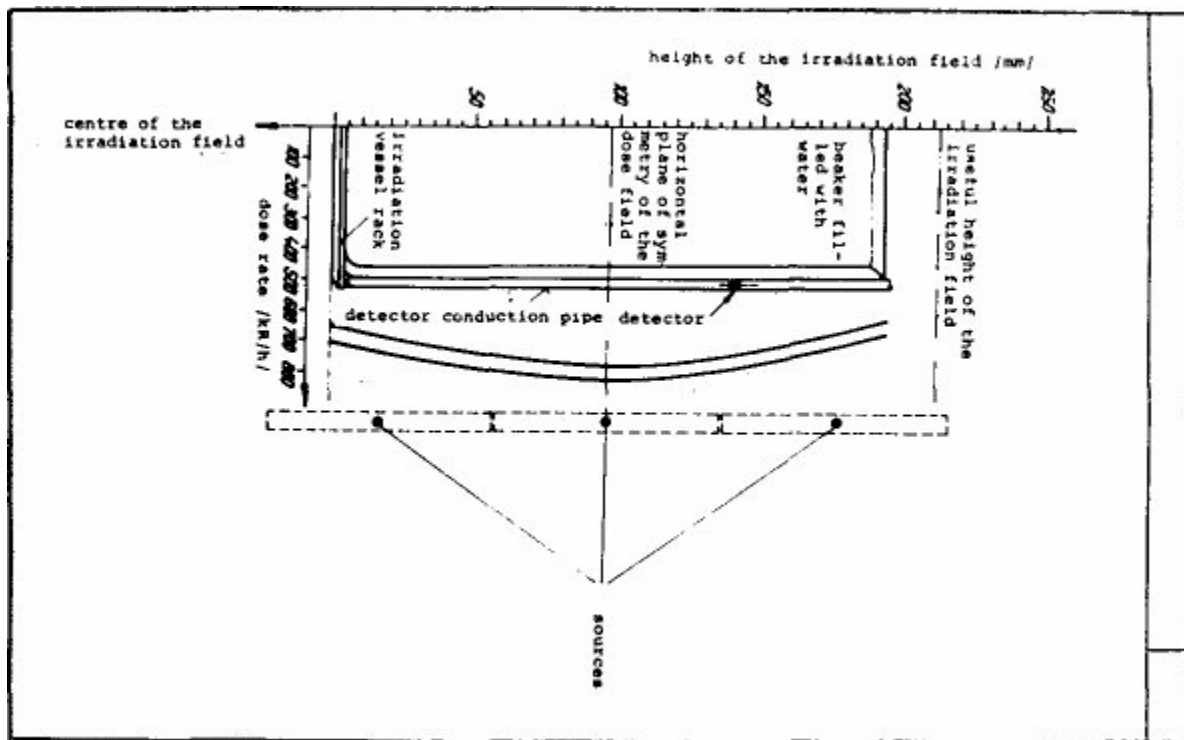

Figure 6. Dose rate distribution of container type irradiation plant of a Soviet RH-gamma 30 source.

You will note that for checking operations, semiconductor detectors may have a great importance^{9,10} (Figure 7). Such devices are applied in six facilities, in Hungary and abroad following the initiative of our Institute.

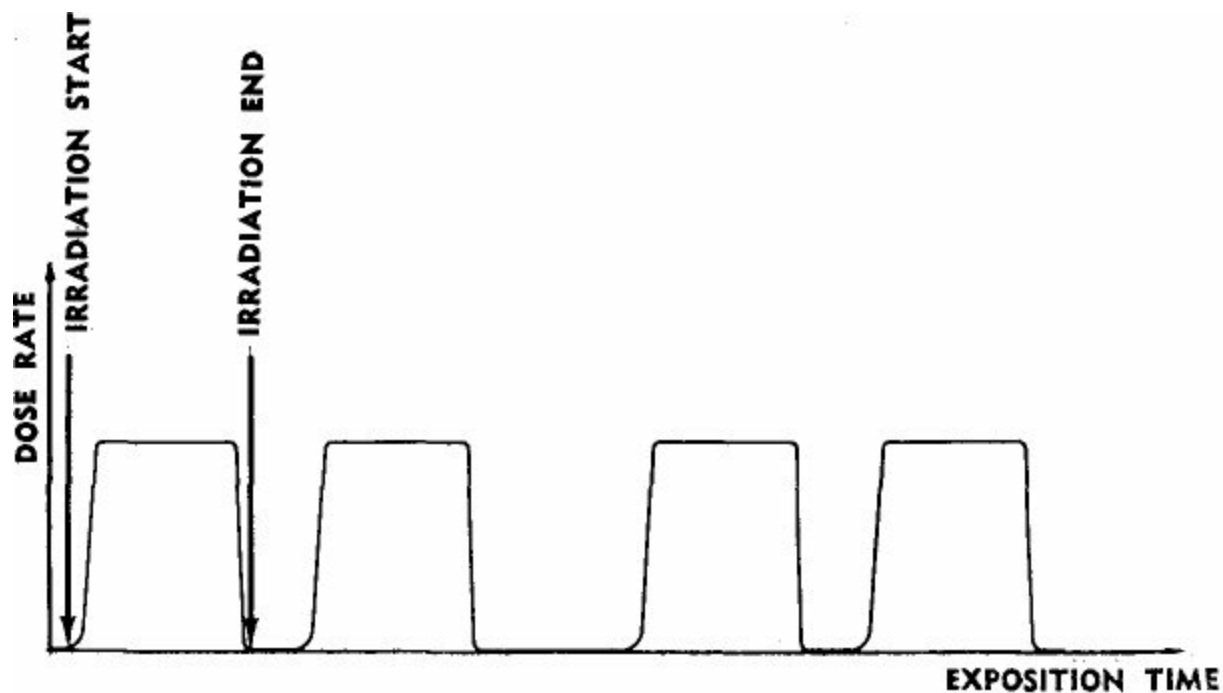

Figure 7. The check of irradiation time and dose at an irradiation facility.

References

1. Hirling, J., Stenger V. One Year's Operational Experience with the First Hungarian High Activity Gamma-Irradiation Facility, (in Hungarian), *Energia és Atomtechnika*, **22**, 447 (1969).
2. Fejes, P., Horváth, Zs., Stenger, V. The Calculation of the Relative Irradiation Dose Rate of a High-Power Gamma Source by Digital Computer, *Isotopenpraxis* **6**, 98 (1970).
3. Horváth, Zs., Stenger, V., Földiák, G., Fejes, P. Determination of the Dose Rate Field of High Intensity Gamma-Sources (in Hungarian), *Isotóptechnikai Kutatások*, MTA Jzotóp Intézete, Budapest, 1972, p. 41.
4. Stenger, V., Pavlicsek, I. Use of Diodes in Rapid Measurement of High Gamma-Intensities (in Hungarian), *Atomtechnikai Tájékoztató* **13**, 339 (1970).
5. Hirling, J., Stenger, V., Fekete, Z. Development of High Activity-Irradiation Plants (in Hungarian), *Isotóptechnikai Kutatások*, MTA Izotóp Intézete, Budapest, 1972, p. 269.
6. Pavlicsek I., Stenger, V., Csürös, M., Lakosi, L., Veres, Á. Comparison of Measurement Methods of High Gamma-Intensities, II (in Hungarian), *Izotóptechnika* **14**, 466 (1971).
7. Osvay M., Tárcy, K. Production and Using Radiation Resistant Detectors for Gamma Dose Rate Measurement (in Hungarian), *Izotóptechnika* **16**, 307-327 (1973).
8. Tirling, J. Experimental Radiation Facility of Food. *Atomtechnikai Tájékoztató* **9/10**, 293-312 (1969).
9. Stenger, V. Use of K-120 Research Source for Pilot Plant Irradiations (in Hungarian), *Izotóptechnika* **15**, 485 (1972).
10. Földiák, G., Horváth, Zs., Stenger V. Routine Dosimetry for High-Activity Gamma-Irradiation Facilities, *Dosimetry in Agriculture, Industry, Biology and Medicine*, IAEA, Vienna, 1972, p. 367.

Dosimetric inspection system of gamma-irradiation facilities

Zs. Horváth

Institute of Isotopes of the Hungarian Academy of Sciences, H-1525 Budapest 114, P.O.B. 77, Hungary.

Pilot plant scale radiation sterilization represents one of the regular activities of the ^{60}Co gamma-irradiation facility (80,000 Ci nominal activity) of our Institute.

In the following, the dose monitoring system of the facility, developed during its 5 years of operation as well as the measurement of doses suitable for certifications of dose will be described.

Since our irradiation facility is not a continuous system, regular dosimetric monitoring involving a relatively large number of measurements is undoubtedly necessary. A space compensation method, suitable for assuring dose homogeneity similar to that obtained with large scale irradiation facilities will be shown in Figure 1 where one irradiated unit is shown as an example: The total irradiation time is divided into four parts. The boxes are rotated according to the arrows shown in the Figure. Those black dots indicate the position of chemical dosimeters. By using boxes of four dosimetric ampoules made of glass or plastic arranged according to the Figure it is possible to get a practically complete picture about the distribution of the surface irradiation dose.

The capacity of the facility is 400 cubic meters per year. One irradiation cycle permits to irradiate 20 boxes of $400 \times 400 \times 700$ mm dimension (Figure 2). This corresponds to 80 dosimetric control measurements, according to the above described procedure. This task can be performed rapidly and with appropriate accuracy, by using an alcoholic chlorobenzene dosimeter with oscillometric evaluation^{1,2,3}. Oscillometric measurement and evaluation of irradiated ampoules (6.5 cm^3) containing alcoholic chlorobenzene (6.0 cm^3) requires about 1 minute per ampoule (Figure 3).

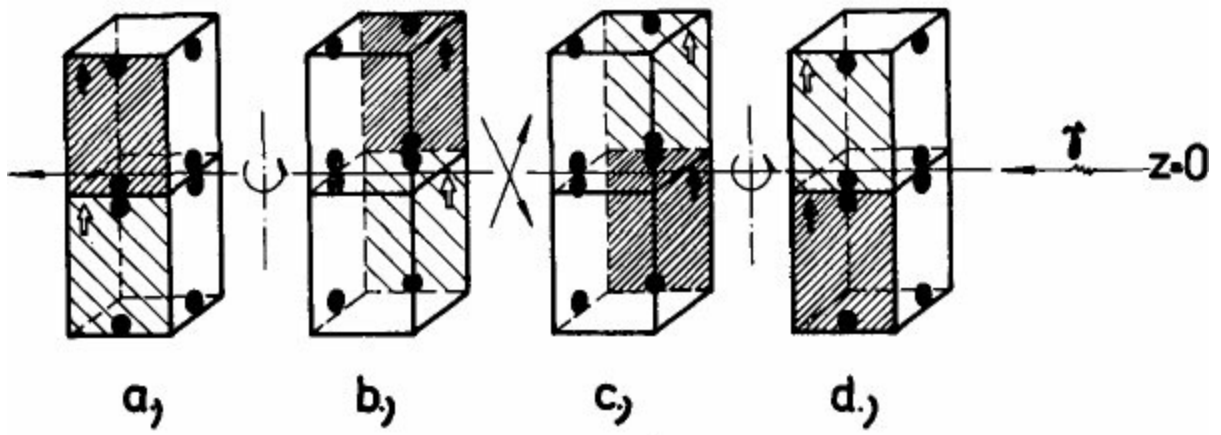

Figure 1. The steps of space compensation for one irradiated unit.

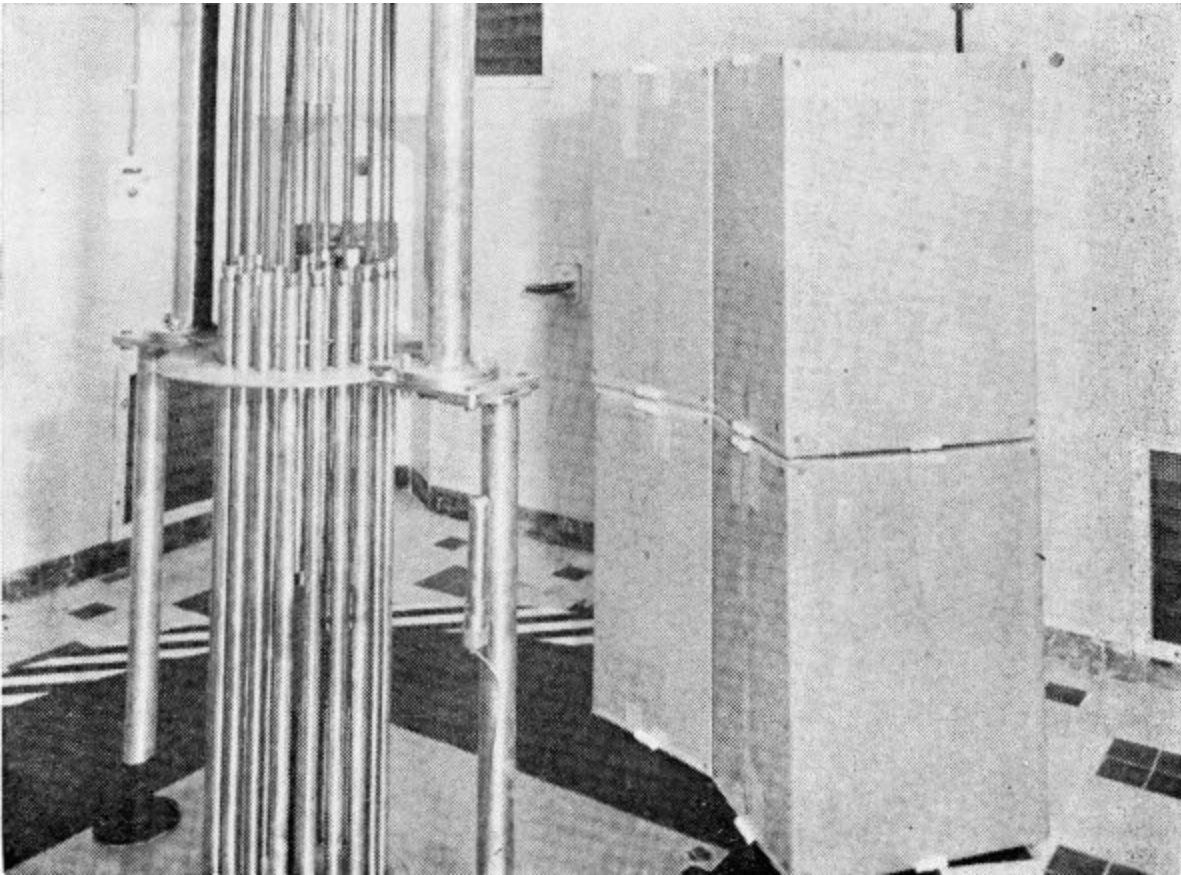

Figure 2. Boxes with dosimetric samples placed in the irradiation chamber.



Figure 3. Oscillometric measurement of irradiated ampoules.

The dose ratio was equal to 1.16 during a radiation sterilization process as described above. In our radiation-sterilization practice approximately 15,000 dosimetric measurements were carried out. On the basis of evaluation of more than 800 ampoules it can be stated that the prescribed dose, i.e. 2.8 Mrad can be determined within an experimental error of $\pm 4\%$, i.e. ± 0.1 Mrad. Thus we can guarantee the 2.5 Mrad absorbed dose with the required security.

Analytical evaluation of irradiated ampoules does not require their opening and can be performed with the necessary reproducibility. The behaviour of irradiated ampoules during storage in darkness for several years has been investigated. Evaluation of 100 ampoules was repeated every three months during a period of 3.5 years. The deviations exhibited a statistical scattering and did not exceed the average error of the analytical procedure. Thus, the alcoholic chlorobenzene dosimetry with oscillometric evaluation is suitable for rapid evaluation of many samples, and, in addition, its use ensures the certification of irradiation dose within the total period of the guarantee.

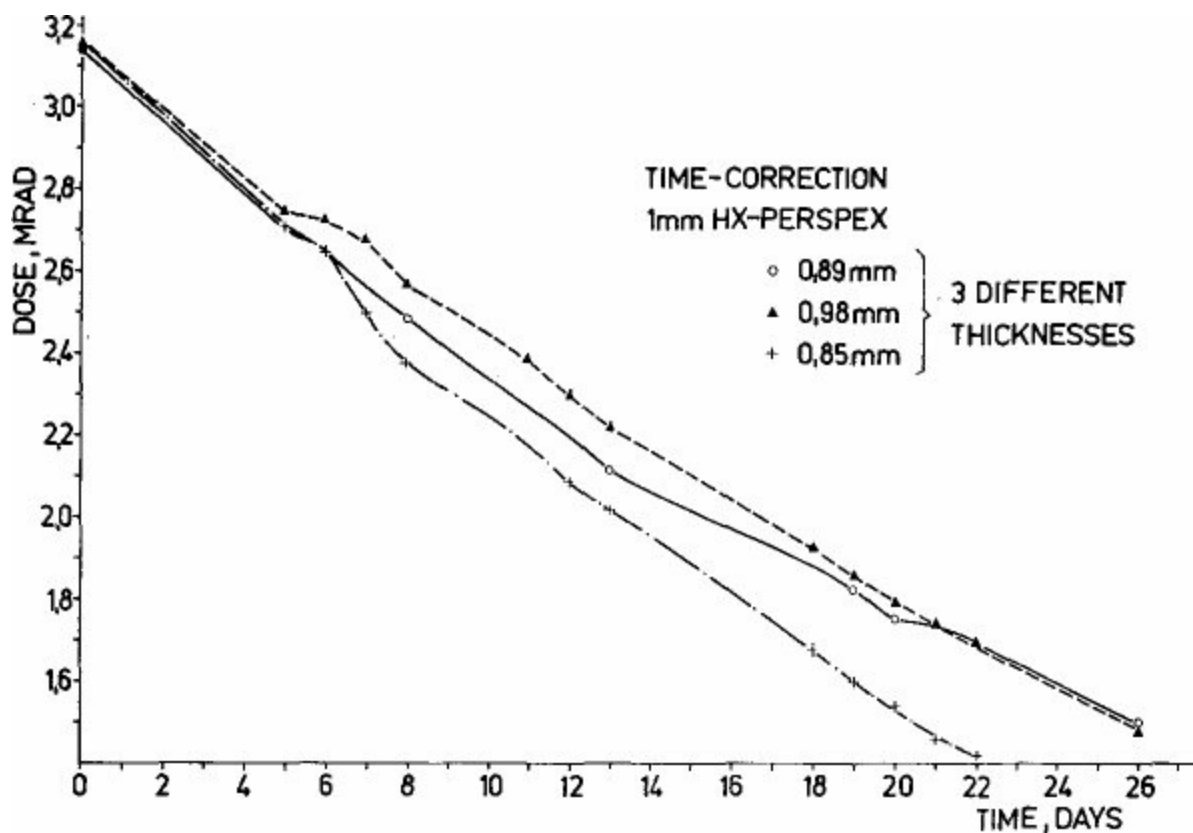

Figure 4. Time correction for Perspex™ dosimeters.

Comparative experiments were carried out with different Perspex™ dosimeters applied in a continuous gamma irradiation facility in Europe. Both ampoules containing alcoholic chlorobenzene and Perspex™ dosimeters were irradiated under identical conditions in our partner's facility. Then the Perspex™ samples were evaluated by the partner while the ampoules were mailed to us for evaluation. An absorbed dose of 3.20 Mrad was obtained as an average of 10 chlorobenzene samples, whereas, the corresponding result with Perspex™ dosimeters was 3.25 Mrad, the difference being as low as 1.5%.

A much worse result was obtained in the reverse experiment, when Perspex™ dosimeters irradiated, sent to our partner and evaluation took place only after 22 days of irradiation. Chlorobenzene samples were evaluated twice: first immediately after irradiation, and 35 days later. Practically no change was observed between the two values. In spite of the time correction being carried out for the Perspex™ dosimeters, according to the curve shown (in the Figure 4), a difference as high as 18.4% was observed between the dose results measured by the two different methods.

This clearly indicates the great advantage of the oscillometric chlorobenzene dosimetry, namely the stability in time and the possibility of subsequent checking during the whole guarantee period which is important for both the hygiene authorities and the manufacturer.

References

1. Dvornik, I., Zec, U., Ranogajec, F. *Food Irradiation* International Atomic Energy Agency, Vienna (1966), p. 81.
2. Horváth, Zs., Bányai, É., Földiák, G. *Radiochim. Acta.* **13**, (1970) p. 150.
3. Földiák, G., Horváth, Zs., Stenger, V. *Dosimetry in Agriculture, Industry, Biology and Medicine*, International Atomic Energy Agency, Vienna (1973), p. 367.

General Discussion

Comments by Moderator:

I'd like at this point, to take Moderator's prerogative and pick up a few of the points that I feel have emerged from the discussions today and that we ought to come back to in general discussion from the floor.

Now, I think first we must ask the question — Do we need dosimetry in irradiation sterilization? I'm not talking about irradiation processing where the chemical effect which one seeks can often be used as its own dosimeter. I think when we consider irradiation sterilization we must emphatically say there is no substitute for the use of good dosimetry to determine whether the product, once you know what's its initial contamination is, whether that product has received an irradiation dose adequate to render it sterile, with a high probability. Now, how good must our dosimetric systems be? I think I must remind you that the 5% level that Dr. Chadwick tossed off there, $\pm 5\%$ of 2.5 megarads is 125,000 rads, which is a difference of a factor of 1000 in the survival of the average radiosensitive microorganism and it's even a difference of about a factor of 10 in the survival of the average virus. So 5% is a large amount in terms of the chance of rendering a particular item sterile. Now Dr. Ellis produced a slide which I'd like to remind you of. Could I have that one blue slide (see Figure 1, page 208) and this evolves from the last question. Because one dosimeter does not answer all our needs, primary standards should be in the repository of the National Laboratory and must be accurate to the order of 1% or at worst 2%. Do we need a primary standard for the megarad range or can we scale up from the existing standard at lower total doses? Is a dose rate standard enough so one controls the exposure by time only? I'd like to hear some discussion of that. We referred to a secondary standard, which presumably we use in the calibration of a new product. What level of accuracy are we going to demand of this standard? Routine dosimetric systems — what are we asking them to check? Are we asking them to check that this type is operating correctly? International intercomparisons — are we going to do this by direct primary standard intercomparison or through a secondary transportable standard? And if so, can we achieve accuracy of a high enough degree to allow us to adopt internationally standards accepted in other countries? I would like to hear comments on this. All of these subjects have been talked around but not talked directly to during this meeting.

I think we must specify more carefully than we have done up to now what we expect of dosimetry. Do we expect it to tell us that a standard microorganism is eliminated to a predictable extent in a new facility? That bio-dosimetry can be done? Do we need this in addition to physical dosimetry? In what circumstances do we need it? Or does physical dosimetry, properly done with the right system, answer

this question? Do we need to do biological dosimetry more often than at the commissioning of the plant? Should it be done on a routine basis? My own feeling is no. But I'd like to hear this discussed. I think we can say that the physical dosimetry abetted by some form of biological dosimetry at commissioning must replace any sterility testing of the product, because sterility testing, particularly of the complex products that are sterilized by irradiation, is totally impractical, as well as being inefficient. It would not give us the degree of safety that we already demand. I'd like to hear this point discussed.

Comments by:

K. MORGANSTERN — USA

Do you think there will ever be a go, no go dosimeter which will ever be cheap enough to go along with each medical disposable irradiated product? Also, I would like to ask; is it necessary?

Comments by:

K. H. Chadwick — The Netherlands

I would like to say that I believe the physical measurement of irradiation dose provides the guarantee or can be used to provide the guarantee for the irradiation sterilization process and I believe dosimetry is accurate enough to give this guarantee. What I would like to repeat, is what I said this morning, that when the process is properly commissioned and I think this does involve a few more measurements than normally may be imagined and the plant has built-in facilities for the automatic monitoring of the mechanical and electrical features, then I don't think dosimetry is necessary for the control of the process. When I think about this, I always remember a story which I heard when we were discussing this problem once. A story from a friend of mine, and you probably know him. He told a story of commissioning a special plant and they were doing a 48-hour demonstration of continuity. They were monitoring the process using dosimeters, using the measurements of cycle time, source positioning, and dose rate from the source, etc. for the facility. At a certain moment, the measurement of the cycle time on the control panel indicated that there were some electronic faults in the timing somewhere. They carried on the continuity run and this did not show on the dosimeter for another 12 hours after it was clearly indicated on the timing mechanism measurement. I think this is a very good example of where my faith lies. I think you can detect a process going wrong far quicker by measuring the plant parameters than by using a dosimeter. So I think that this more or less comes to Dr. Morganstern's question. If you set the process properly, this might be more difficult with electron machine because you have more parameters to control, but once you get that process set-up, I don't think dosimetry is going to do any more than keep an assistant busy.

Comment by:

W. A. JENNINGS — England

I'd like to make a number of comments. I don't agree with the previous speaker and I'd like to make another comment on what he said this morning. He mentioned for example that one of his standardization facilities partly came to pieces because some of the rods slipped and hence said this could happen. The only way in fact to be certain, in addition to checking parameters, is to check the dose in the actual products. Well, I would have thought it essential as a guarantee that certainly every so

many products must be checked by dosimeters. This does not mean you don't check parameters also. Secondly, with regard to accuracy, I was most unhappy with the general illustration compared to horses by the Doctor. I thought this gave an atmosphere of a gamble to dosimetry, which I feel is unfortunate. I don't feel that this a gamble. I feel, in fact, that the level of accuracy which can be achieved is much greater than the impression given. For example, we have now standardized the calorimetry dosimeter well within 1%. The red Perspex™ or clear Perspex™, providing you take care on thickness, can certainly be calibrated to within 4% at a 99% confidence limit. That is, the odds are 100 to one that you will be within 4%. Moreover, if you had 3 millimeter Perspex™, that number becomes 2.1% at 99% confidence limits. I feel this accuracy is quite sufficient to provide guarantees for the system upon which the whole of this meeting, in fact, depends.

As for international collaboration, let me add that the National Standard Laboratories has a close liaison. There is in fact a consultative committee on standards and measurements for ionizing irradiation of the International Committee for Weights and Measures. I happen to be the chairman; so I know. This body meets regularly. At the present time it is largely concerned with calibration of the radiotherapy level, but on its agenda are protection levels and megarad levels for discussion. Therefore, the mechanism for intercomparison at these levels exists and it only has to be brought into place. I'm sure this could all be set in motion and the appropriate system adopted for this purpose.

Comments by:

K. H. CHADWICK — The Netherlands

I think your point is extremely well taken Dr. Jennings. First, let me deal with the horse racing. I'm not a gambling man myself and if you read my paper in the text, you won't find any reference to horse racing or gambling. This was an attempt to keep those of you accustomed with some dosimetry criteria and dosimetry problems awake, while I tried to get a message to the people who were not familiar with it, and I'm sorry if this gave a completely wrong impression about my opinion on the reliability of dosimetry systems. Secondly, I agree completely the Perspex™ dosimetry systems certainly can be calibrated; this is my experience with the clear Perspex™ anyway. You certainly can calibrate it at this level and I think at 99% you're in fact implying two standard deviations, if not, three standard deviations at 95%. This I think is true. If I come back to the question of our source pencil moving along the rack, which is one of the points you made for including a dosimetry system in the products in the continuous operation of the plant, we had not detected it, nor would we detect it, in a dosimeter in the product. This is because it's rather irrelevant if the pencil moved slightly to one side when your product is passing completely along the source. So this is something which we would only have detected in the continuous operation plant by having a dose rate meter in a fixed position somewhere in the plant, something like the semi-conductor Professor Horváth, of the Földiák group, talked about. One thing which heartened me this afternoon is the intercomparison of Mrs. Horváth between alcoholic chlorobenzene and Perspex™. I know where this work was done. I didn't know, however, it had been done. This confirms my opinion that dosimetry intercomparisons are very useful. It also confirms my feeling that dose accuracy is very good when I think of who calibrated the Perspex™ dosimeters. I believe, it was National Physical Laboratory and Mrs Horváth calibrated the alcoholic chlorobenzene. I think this is just confirming what I really think about dosimetry.

Single user license provided by AAMI. Further copying, networking, and distribution prohibited.

Comments by:

A. CHARLESBY — England

I'm a bit worried because we all seem to have these same discussions on risks and these risks are taken as absolute values rather than relative values. Let me give you one figure. You mention a 5% error in dosimetry could lead up to a factor of 10^3 in the risk. That means at 100% that you're working on a safety factor of 20 times a 10^3 factor. Now you're going to fly home on an aircraft which has not a safety factor of 10. I think we're losing all proportions. Now let me take another example. We're going to make the thing sterile. Has anyone produced any evidence at all on whether or not the package is air tight? Is there anything like accuracy? I mean, it would seem to me we're taking a very minute fraction putting on the 10's, and adding more 10's and more 10's and forgetting about the rest. It would seem to me we have lost all proportion. Perhaps I'm a bit too strong on this. Just one other point which I might make. In fact, we have a built-in dose in lots of these things. This polyethylene film; I've not done any work on, at least not very much in connection with polyethylene as a dosimeter, but when you irradiate polyethylene you get unsaturation which you can check very easily with the infrared. It measures around about the right dose of a few megarads, its independent of temperature, almost independent of type of irradiation and you don't have to do anything except, when you're worried, you take a piece of the packaging film off to look at it. You don't have to do anything at all. Now what would you want with a dosimeter?

Comments by:

A. BISHOP — England

Could I just presume to add to what Professor Charlesby has said. I was sitting there thinking to myself that we had gone wildly off the path. Those plants that my Department approved, where the dosimetry is checked by my friends and colleagues in the NPL, I believe that the dosimetry is right. I hesitate to say that dosimetry is good enough, but in the context of the other hazards, that Dr. Charlesby observed, it certainly is good enough. Here we are dealing, if I may say so, with highly dubious methods of sterilizing compared with proper methods involving heat. Somebody yesterday entertained us to rather dubious statistics about the number of organisms per article having an inactivation factor of 10^7 , or whatever. If you sit, as I have, and look at a process like this, it depends on what is an article in this context such as a pack; you know, a ward procedure pack with about 8 sets of dressing in it which is put into the plant as a unit. Is this one unit or is it 8 units? If it's made of cotton or something there are a lot of organisms on this from the variations of the number of organisms from one manufacturer to another, from one country of origin to another, etc. It is many orders different from the 5% that you, Mr. Chairman, are using to cast scorn on our dosimetry. May I put in a plea that dosimetry is right and many of the other things are not right. We should worry much more about the cleanliness of the things that we are irradiating and be content that certainly in the States, in Scandinavia and in Germany and in the countries that we have looked at, dosimetry is probably all right.

Comments by Moderator:

R. J. BERRY — England

I accept your strictures. My comment of the effect of a 5% variation in dose stems from the fact

that in other situations where one is looking for a biological effect which is the threshold effect, the presence or absence of microorganisms on one of a very large batch of items is a go, no-go situation. But there are other situations where a 5% biological difference can be detected. Certainly, it is true in radiotherapy. The radiotherapists can detect a difference of about 7% in dose; admittedly not further, but that is well within capabilities. However, I accept what you say; you are absolutely right. The cleanliness of the product that is subjected to the sterilization process has received far less attention than it rightly deserves. The process itself has been subjected to rather more than stringent examination. I think, and particularly today, more than it needs perhaps.

Comment by:

S. NABLO — USA

I'd like to make a comment about this which in a sense supports Dr. Chadwick's relating to physical monitoring of sterilization. I think there are classes of processes involving continuous sterilization which most people haven't thought of a great deal. It's an area in which we've been particularly active so I'd like to throw these comments out. If one is to use irradiation, let's say low energy electrons, low energy electron sterilizers for continuous treatment of webs, let's say in a continuous packaging process, a flat form-filled and sealed package as it is sometimes called, then the only alternative is the use of physical measurement of all electrical parameters of the sterilizer itself. That means a continuous monitoring of the energy of the sterilizing agent, namely the electrons and the current which is the flux striking the film itself.

Now I would suggest that there are classes of applications coming within the next decade in which this real time monitoring of sterilization is only possible by physical measurement and there is no dosimetry technique which will permit real time monitoring of high speed continuous sterilization.

Comment by:

Mr. RICHMOND — USA

Well, I agree fully with Professor Charlesby and Mr. Bishop concerning the fact that dosimetry is wonderful and everybody else has the problems. I would like to point out that 5% in your dose represents money. From the point of view of an industrial firm, if there was a way of improving my measurements so I could reduce the dose given to my system by 5%, I'd be very happy to find it. This has nothing to do with all these probabilities. It's a money factor and I think that should be borne in mind. Then I'd like to switch to another subject and get to the IAEA experience with regard to international intercomparisons. I agree fully with Dr. Chadwick's position this morning. I would also say that if somebody told me that the National Physics Laboratory or the National Bureau of Standards had accuracy to 1%, I would believe them because they have done their work using various systems which are totally different from one another to achieve accuracy and reproducibility. However, I suspect when you get to international situations, when you get to industrial plants, when you get to facilities in countries where they don't have multiple facilities to make measurements, you'll find that while they may have very high precision, the problem of accuracy does arise. The International Agency in carrying out intercomparison studies has found that very frequently good laboratories will achieve very high precision and I'm not now talking about dosimetry of high level irradiation, I'm talking, in general, with regard to people who know statistics, who know analytical chemistry, who know

counting. However, frequently there are great differences in accuracy and these often are traced down to systematic errors which can be corrected.

So a furtherance of intercomparison will improve the situation for all those laboratories. However, it's also been observed that when staff changes, new systematic errors creep in so intercomparisons must be performed on a continuing basis. You cannot make one intercomparison and rest there. You must continue to do this. This is the kind of activity that will not place a great burden on the organization carrying out the co-operative effort, rather the burden is on the laboratories doing the work. I would like to support this position.

Comment:

ANONYMOUS

The National Standard Laboratories and International Laboratories provide calibration services as well as supervised inter-laboratory intercomparisons. It's the periodic calibration service that provides accuracy.

Comment by:

H. EISENLOHR — Austria

I want to come back to the very first question. The dosimetry section of the IAEA presently is involved in setting up so-called Secondary Standards Dosimetry Laboratories in some countries of the world. This involves mainly the calibration of dosimeters used in therapy and irradiation protection and I see now that they perhaps should also take over the task of calibrating dosimeters in the high dose range. My question is to the representative of the primary National Laboratory and I repeat your question: Do they really have a plan? Do they really have dosimetry standards in the dose range of 2 to 10 megarads? Only then, I believe, can we think that the secondary dose labs can do the same thing.

Comment by:

S. ELLIS — England

I think we've really come down to discussing that slide which you put up. Let me say I think there is a need for primary standards in the megarad range and I think these should be set by the National Standards Laboratories. Now you raised the question ... Is the reference standard a necessary thing? I think that it is a necessary thing in order to be able to transfer the measurements from the primary standard to the working situation and also to carry out intercomparisons between primary standards in separate laboratories. Now what is one looking at when one intercompares primary standards? I think the primary objective here, when one intercompares with the National Standards Laboratory, one is looking for systematic errors, which we will be too pompous to admit could ever appear, yet exist. When one is making a check in the vertical direction, then one is transferring the standard and it is so rightly said, one is checking out at regular intervals, if you like, the error. Very often, one is concerned in this direction not so much with the systematic error but a mistake. I think this is the point that is being made and I think this has been our experience in the area of irradiation therapy. At those dose levels when one makes an intercomparison in the vertical direction, directly to the working situation, the thing that you will very often find is that something has gone wrong, and this I think I would call a

mistake rather than a statistical uncertainty.

With regard to the question of setting up standards as you saw on the slide this morning, we have cobalt-60 at a megarad per hour level and we have installed an electron accelerator, a Linac, and it is our intention to use those in this range to provide a standard.

Comment by:

W. L. McLAUGHLIN — USA

As Dr. Ellis' counterpart on the other side of the pond, I should add a few words in answer to Dr. Eisenlohr's question. There are indeed calibration services in the megarad range and as is necessary, there are calibration services for both cobalt-60 gamma radiation and for various electron beams of different energies. We have a Linac up to about 120 MeV for which we are beginning to provide calibration services with various sensors. We have single pulse accelerators for very high-intensity single-pulse electron beams. It is important that the dosimeter or sensor, whatever it may be, is calibrated in the field of interest and with about nine accelerators and four cobalt-60 sensors, we are trying to take care of as many irradiation environments as possible in the megarad range.

Comment by:

A. CHAPIRO — France

I would like to draw your attention to the fact that this discussion is far from being exhausted and radiation dosimetry is really an unlimited field, especially if we have so many different concepts. I'm a user of radiation dosimetry, and an irradiation chemist in a position which is somewhat similar to people who use irradiation for sterilizing. We are really users and what we want is a method to determine what amount of energy we are giving to a certain object. Now, I entirely agree with the National Standard Laboratory, it is very important to work and develop more reliable and more sophisticated methods of irradiation dosimetry for the users and this is what really was the reason for my earlier written question. There are enough dosimeters, chemical or physical dosimeters, available which are accurate enough and reliable.

The point is, one has to select from among these many possibilities the one that is more appropriate for your task. The more dosimeters we have, the more this choice will be difficult. This was my point. Now, I think that for the problem of sterilizing a box, the important point is to ensure that any part of the contents of the box has received a special dose of say 2.5 megarads. Whether or not there is a slight overdose in other parts, may be a question of economy, as one of the speakers said before, but I consider that 5% expense to ensure security is really nothing. It is much more expensive to have safety belts in your car to avoid accidents. We are really in a position where there are available methods and it is really a question of finding the reliable process. If, however, the source is an electron accelerator which can vary in electrical steadiness, it has electrical monitoring, but it could be useful, and is probably useful, to have a label on the package and to check that each package has received the appropriate dose.

Comment by:

W. McLAUGHLIN — USA

I think there was one question that was not answered. It was a very simple question with a simple answer. I think it was Dr. Morganstern who asked: Are there any inexpensive go, no-go dosimeters? The answer is *no*.

Comment by:

J. C. KELSEY — England

Before we wind up, I'm going to use my prerogative to comment on the last answer on go, no-go dosimeters. I know no physics, but I know my hospital. There is the story of a nurse who was found to be giving multiple injections through the same plastic syringe putting it back carefully every time, into its plastic container. When this was challenged, she said: "Look on the label, it says if the spot is red, the syringe is sterile". So if you use go, no-go dosimeters, be careful about educating your public.

THIRD SESSION

Chairmen

D. Schulte-Frohlinde

F. Antoni

Moderator

K. L. Ostrowski

Aspects of the Radiation Chemistry of Small Organic Molecules

D. Schulte-Frohlinde

*Institut für Strahlenchemie im Max-Planck-Institut für Kohlenforschung,
Mülheim a.d. Ruhr, Stiftstrasse 34-36, W.-Germany*

In the first part of the paper the origin of methane formed during gamma-radiolysis of alcohols is discussed and it is concluded that in the case of isopropanol, 70% stems from highly electronically excited states. In a second part, the 185 nm photolysis of alcohols in mixtures is briefly described. The results show that even in cases where energy transfer is not possible the

Abstract: *quantum yields for product formation change strongly with solvent composition. In a third part, free radical reactions, which lead to phosphate ester cleavage and to the splitting of a glycosidic bond in cellobiose, are presented. Splitting of the glycosidic bond in a free radical reaction is possible even in the crystalline state, as the gamma-radiolysis of crystalline lactose monohydrate shows.*

Introduction

The energy absorption from a beam of gamma rays or electrons leads to three kinds of reactive intermediates in organic materials: electrons, radical cations and electronically excited molecules. The chemical reactions including charge neutralization of these species produce molecular products and free radicals. The free radicals then react subsequently to give final products¹. Nowadays it is believed that the G value for total primary ionization is between 4 and 5 in liquids and the G value for reactive excited states may be between 2 and 3. This overall picture of the reaction sequence of the events following absorption of high energy radiation is very complex.

In many cases it is difficult to foresee the behaviour of a system with change of experimental conditions. The reason is that any change in the experimental conditions can have consequences on too many different reactions, e.g. the reactions of the electrons or their solvation reaction, or the reaction of the radical cation, the rate and type of the neutralization reaction, the reaction of the electronically excited molecules, or the reaction of the free radicals.

In the investigation of the mechanism of the product formation under the influence of high energy radiation today, conditions are therefore preferred which allow the investigation in detail, of selected reactions. This can be performed in various ways, e.g. using dilute aqueous solutions in the presence of N₂O in order to study the reaction of OH radicals, using UV light to produce selectively chosen excited states, or using the technique of pulse radiolysis to study primary reactions of electrons and free radicals, using matrix isolation techniques, or in general investigations in frozen media to identify primary species, e.g. radical cations and trapped electrons, etc.

Some recent results from this laboratory are summarized in this article which present results obtained on the formation of methane from isopropanol in order to demonstrate the complexity of the product formation under the influence of high energy radiation. Furthermore, results are presented on

the 185 nm UV photolysis of aliphatic mixtures and on free radical reactions of molecules which may be important in biological material.

Origin of the methane yield in the gamma-radiolysis of liquid isopropanol

Methane is formed in the gamma-radiolysis of alcohols^{2,3,4,5} with G values depending on the degree of branching (Table 1). Thus methanol has a much smaller G(CH₄) value than t-butanol (Table 1). Similar results have been obtained with branched hydrocarbons⁶. Since the increase of C-C bond breaking with an increase in the degree of branching is a general phenomenon, it seems worthwhile to investigate the details of the methane formation.

Table I. — G(methane) for liquid alcohols at room temperature³

CH ₃ OH	0.80	(CH ₃) ₂ CHOH	1.6
CH ₃ CH ₂ OH	0.61	CH ₃ CH ₂ CH(CH ₃)OH	0.69
CH ₃ CH ₂ CH ₂ OH	0.052	(CH ₃) ₂ CHCH ₂ OH	0.13
CH ₃ CH ₂ CH ₂ CH ₂ OH	0.03	(CH ₃) ₃ COH	2.75

Methane is produced with a G value of 1.6 in 100% liquid isopropanol². The methane can be formed by the following reactions:

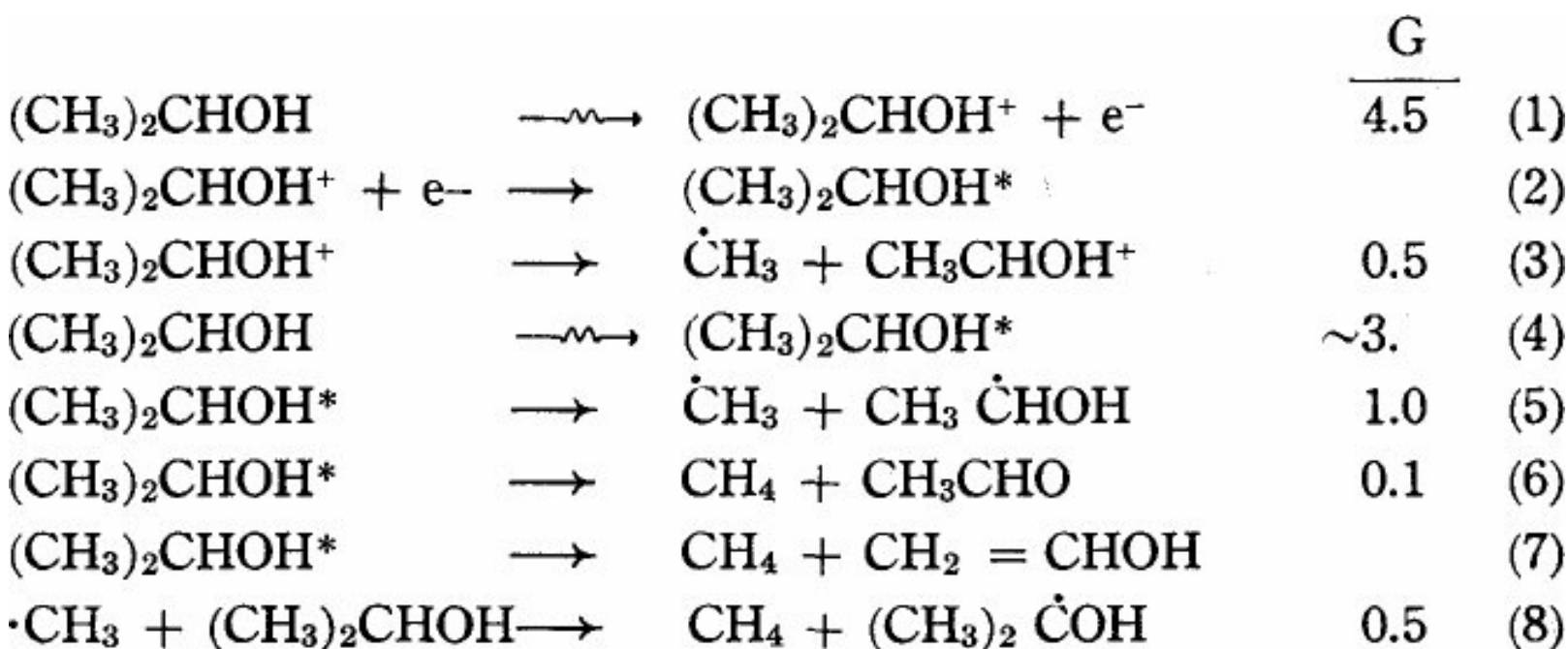

Scavenger experiments with naphthalene and benzophenone show that the G value for reaction 5 is about 1 (ref. 2). The remaining G(CH₄) of 0.6 can only be explained by the occurrence of the molecular decomposition (equations 6 and 7) or the decomposition of the radical cation (equation 3).

Since the true molecular formation of methane has a yield of only 5-6% (G ≈ 0.1), as investigations with deuterated isopropanol molecules have revealed, the decomposition (equation 3) contributes to the methane formation with G ≈ 0.5 (ref. 2, 8). This means that only 30% of the methane is formed via ionic states and 70% via electronically excited states. The excited states may partly have ionic states as

precursors which recombine with electrons within the cage or spur in a very short time (equation 2) and which are not scavengeable with scavengers of concentrations below 10^{-2} M.

Furthermore it can be said that 70% of the methane is produced via thermal CH_3 radicals which are scavengeable, 25% via hot and unscavengeable CH_3 radicals and only about 5%, as stated above, via true molecular fragmentations².

Comparison with the results of the 185 nm photolysis shows that the lowest electronically excited state, as produced with the 185 nm UV light, does not strongly contribute to the methane production⁹. The 185 nm photolysis shows that at this wavelength most of the methane is produced via molecular fragmentation processes and that the quantum yield is very low. Therefore, in the gamma radiolysis highly excited states must be preferentially involved.

From this result it may be concluded that the larger part of the methane yield has electronically excited states as precursors and that the increase in the methane yield as a function of branching is due to the decomposition of the excited states. It seems worthwhile therefore to study the behaviour of electronically excited states in liquids⁷. In this field not very much has been published. Recent results show some surprising results.

185 nm UV photolysis and gamma-radiolysis of mixtures of aliphatic compounds

The radiolysis of mixtures of organic compounds of different composition is one of the methods used to investigate primary processes. In a saturated hydrocarbon the G values for total ionization and total excitation are approximately equal. Since most of the cations recombine very fast with electrons the G value for all electronically excited states, including those which stem from cations which underwent an ion molecule reaction, adds up to approximately 80% of all precursors for product formation¹¹. The behaviour of electronically excited states in mixtures is therefore, for this reason, of importance in the understanding of the product formation.

The easiest way to study the behaviour of excited states in a mixture is to produce them by UV irradiation. However, the distribution of excited states which are formed during gamma radiolysis experimentally are not known. From theoretical studies (e.g. from the so-called optical approximation¹²) it may be expected that all kinds of excited states appear in the gamma-irradiated material. Experimentally it is very difficult to work with UV light with a wavelength below say 150 nm in condensed phases. This investigation was started therefore using the "easy to handle" 185 nm light from a Hg low pressure arc and looking for the influence of solvent composition on the quantum yield for the product formation. The first example is shown in Figure 1. It is the photolysis of a mixture of tert-butanol (t-BuOH) and n-hexane¹³.

The 185 nm UV light is absorbed solely by the t-BuOH even in dilute solution in n-hexane. If there is no interaction with the solvent, then the quantum yields will be independent of concentration. The results in Figure 1 show that the mechanisms of decomposition change from 100% t-BuOH to dilute solution in n-hexane. The product formation in 100% t-BuOH can be explained by assuming preferential splitting of the C-C-bond as a primary process whereas in dilute solution the splitting of the O-H bond is the dominant reaction. This is an unexpected result because the assumption, some years ago, was that the decomposition of electronically excited states of aliphatic compounds occurs very fast

and independent of the environment. Energy transfer cannot take place since the absorption of the n-hexane occurs at a much lower wavelength than that of t-BuOH. The explanations of these results are found in the influence of hydrogen bonding on decomposition of the electronically excited state. If a t-BuOH molecule experiences H bonding then, it is concluded that the probability for the various ways of decomposition is changed. The reason is most likely that the 185 nm UV light is absorbed by a $n-\sigma^*$ bond or an $a^* \rightarrow 3 S$ transition¹⁴ and that the energy and electron distribution of this bond is strongly altered by H bonding. A probe for this is the shift in the absorption spectra due to H bonding in the region of the $n-\sigma^*$ transition on dilution with n-hexane (Figure 2). This kind of result is not restricted to t-BuOH mixtures. Similar results are found for mixtures containing other alcohols like methanol and isopropanol with water, hexane or other alcohols¹⁵.

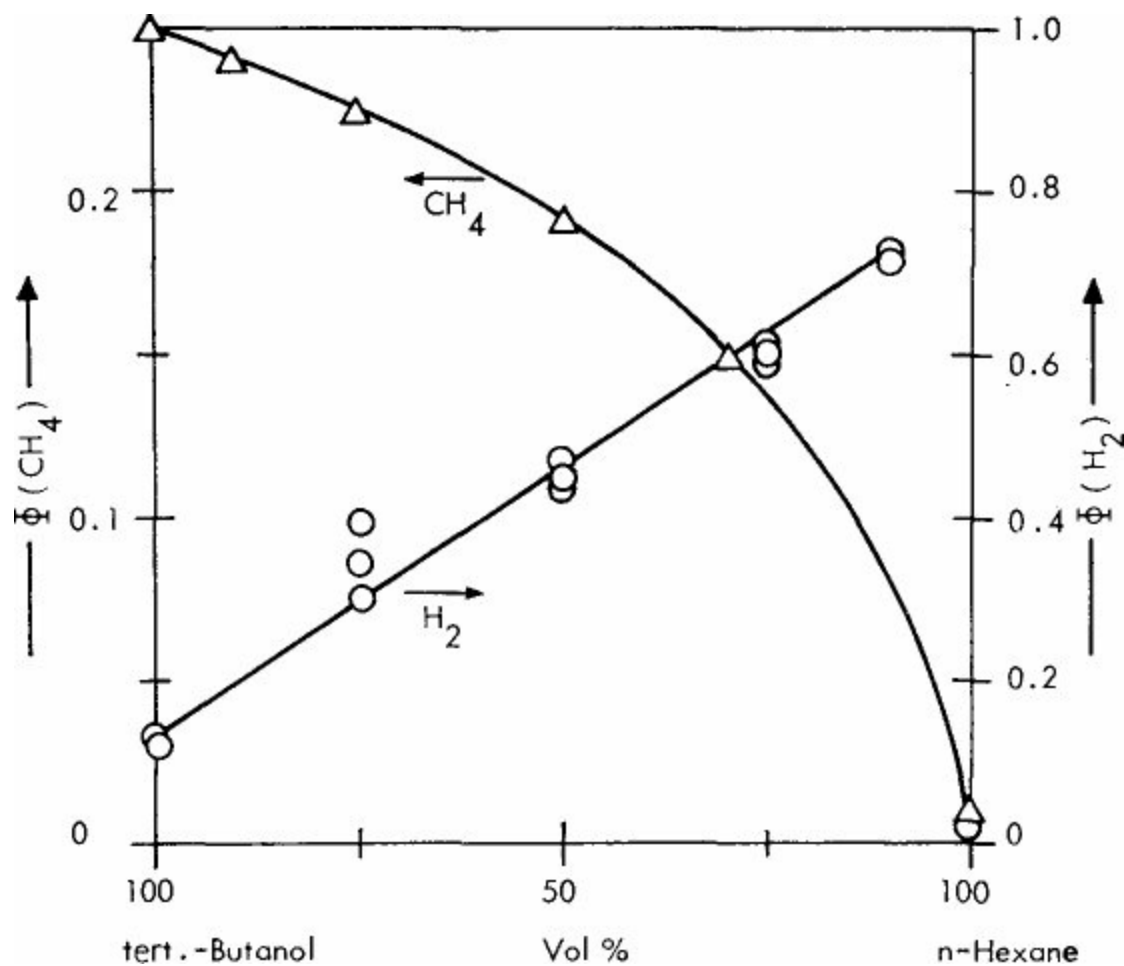

Figure 1. 185 nm Photolysis of t-Butanol/n-Hexane Mixtures at Room Temperature.

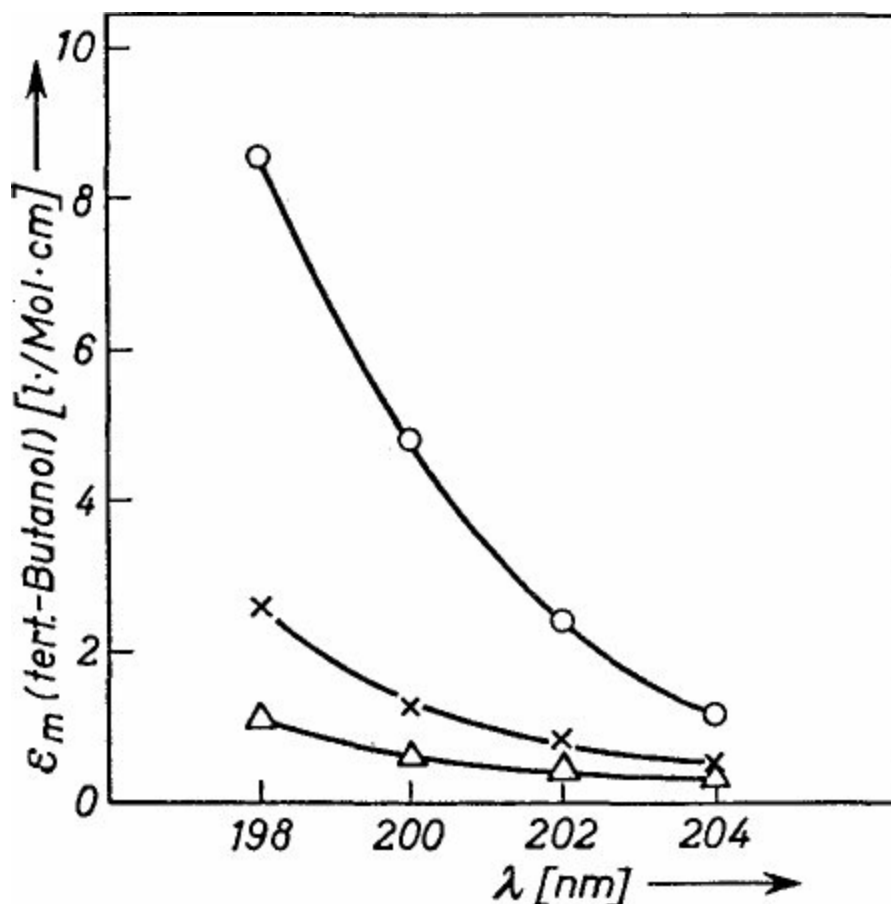
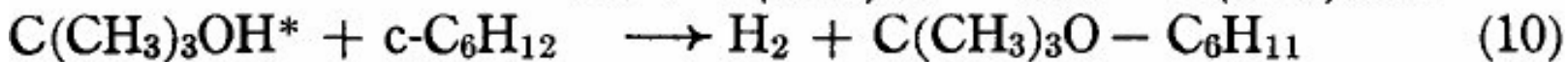

Figure 2. Absorption Spectra of t-Butanol/n-Hexane Mixtures at Room Temperature. 100% t-Butanol Δ ; 4.25 Mol/l t-Butanol in hexane \times ; 0.87 Mol/l t-Butanol in n-Hexane \circ .

Molecular elimination reactions involving two different molecules

During 185 nm photolysis of such mixtures new reactions of electronically excited states are observed¹⁶. Among these are the intermolecular elimination of hydrogen or of methane from electronically excited states denoted by a star in equations 9, 10, 11.



These reactions have no free radical intermediates and must occur by molecular elimination despite the fact that the elimination occurs simultaneously from different molecules.

Product yields in the γ -radiolysis of mixtures

In a binary mixture the G values of the products should obey the so-called "mixture law" if interaction between the components is absent. The mixture law states that the G-values should vary linearly with the electron fraction of the component in the mixture if the energy absorption is based on the Compton effect. Experimental results show that there are only rare cases where the mixture law can

be applied. The reasons for the deviations are manifold. The more prominent of them are, (1) selective reactions of electrons with one component, (2) selection reactions of positive ions, (3) selective reactions of free radicals or (4) energy or charge transfer from one component to the other.

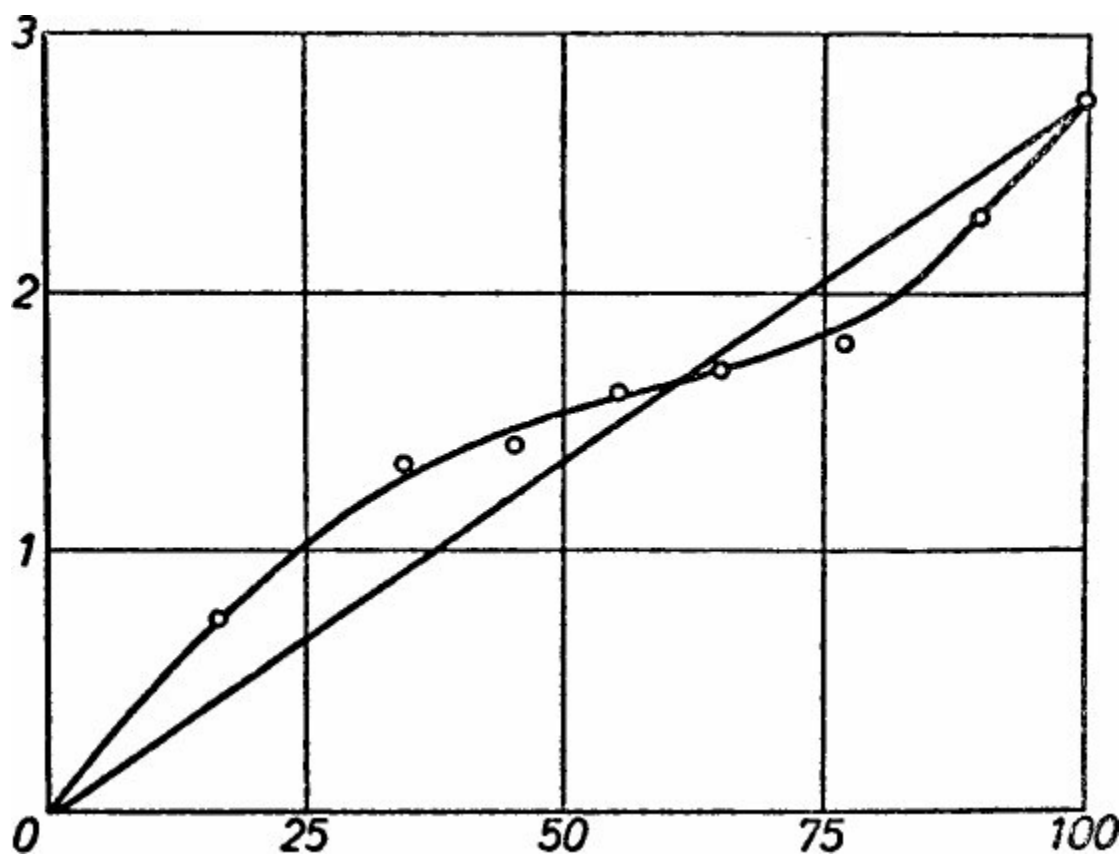

Figure 3. G(methane) in t-Butanol/Water Mixtures at Room Temperature and under addition of 3% H_2SO_4 .

From the foregoing chapter it follows that a fifth possibility exists which may lead to a deviation from the mixture law. This is the change in the quantum yields for the decomposition of excited states as a function of the composition of the mixture. An example of this is probably $G(CH_4)$ from isopropanol as a function of the water content (Figure 3).

The deviation from the mixture law is not caused in this case by energy transfer or different scavenging probabilities as a function of solvent composition since these effects are absent in mixtures containing liquid ammonia (Figure 4), despite the fact that the ionization potential of NH_3 is 2 eV higher than that of t-BuOH or isopropanol. Ammonia is not as strong a H bonding reagent as water and also the H bond formation of water produces the deviation via an influence on the decomposition of excited states.

A major question of importance remains unanswered. What is the behaviour of the higher excited states as a function of the solvent composition? More experimental results are necessary in this field.

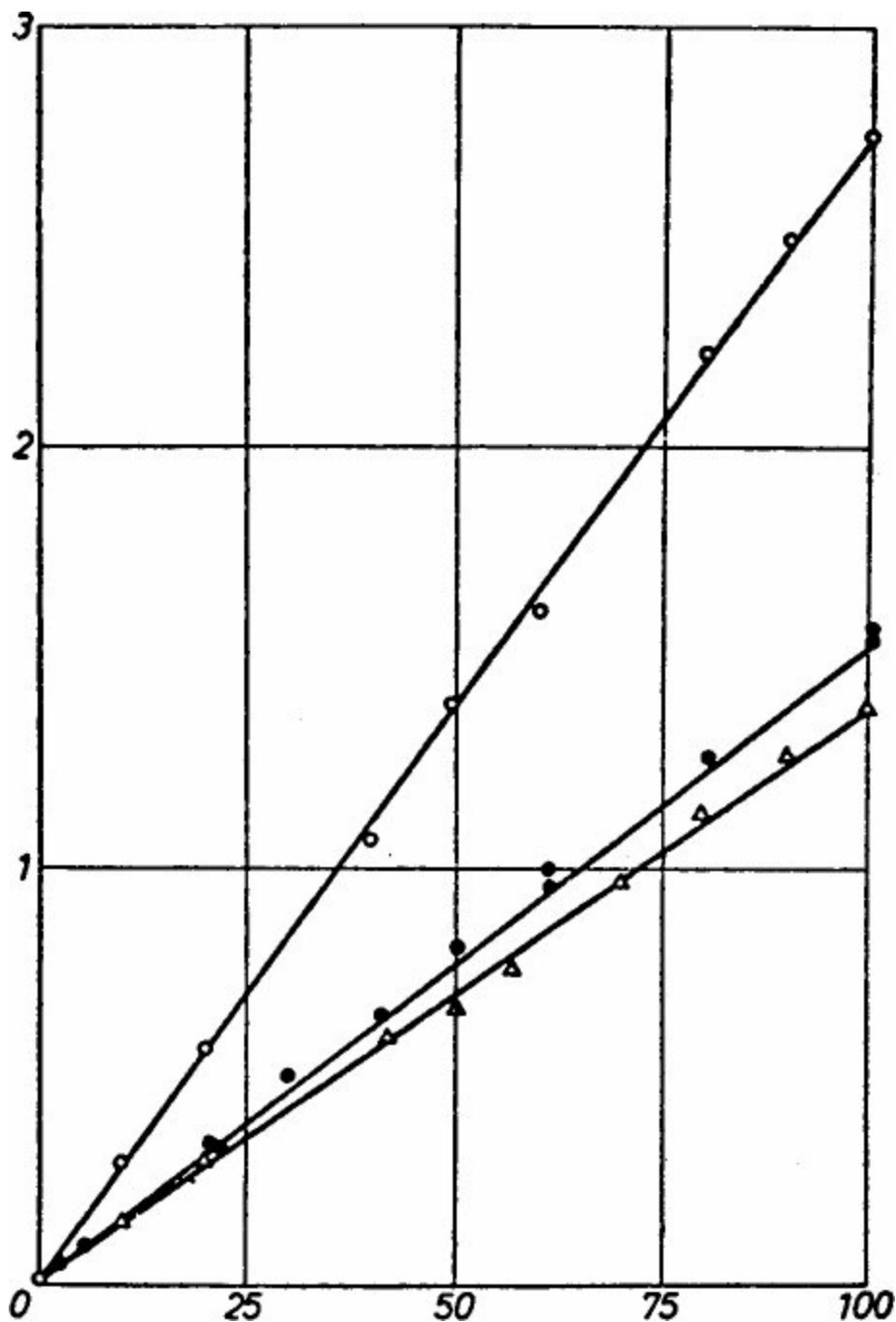
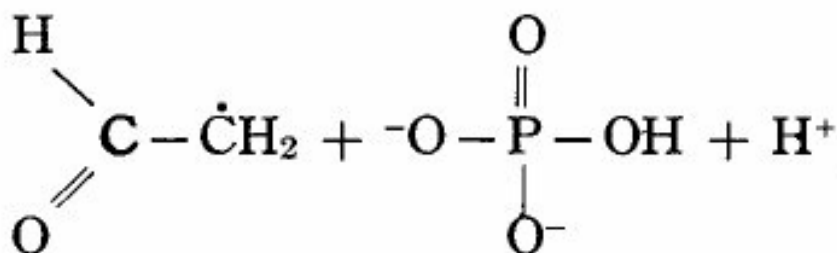
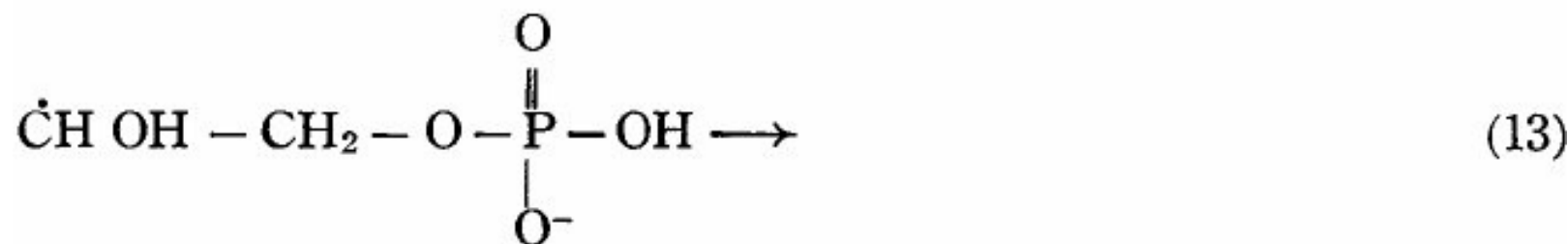
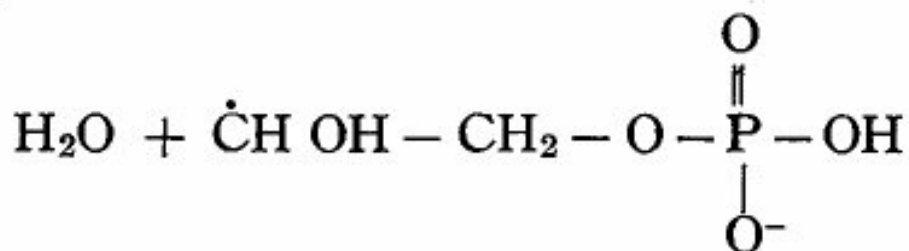
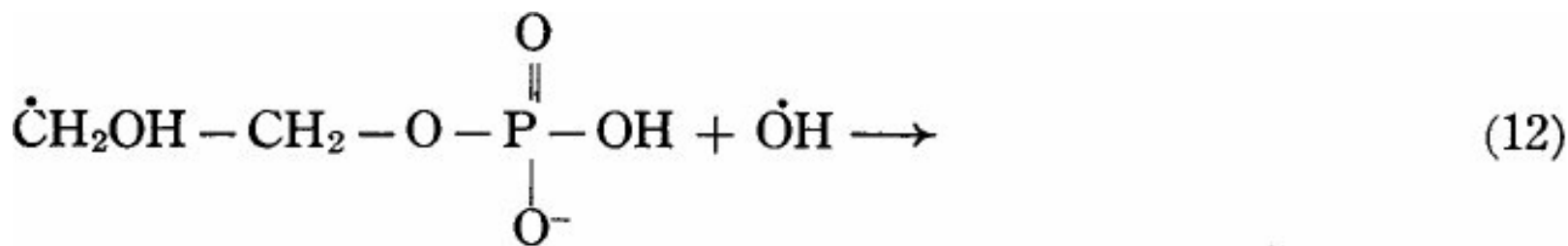

Figure 4. G (methane) in t-Butanol Mixtures with Liquid Ammonia ○, with Dimethylamine △ and with Isopropanol ● at Room Temperature.

Free Radical Reactions

Phosphate ester cleavage by free radical attack

As mentioned above free radical reactions play an important role in all irradiated organic materials. In many cases they can be studied in dilute solution. As an example, investigations on model compounds are presented which show free radical mechanisms which may cause chain breaks in DNA. A chain break in a DNA molecule is a damage which leads to deactivation of phages and bacteria if this damage is not repaired¹⁷. From studies of the end groups of the fragments it is known that the cleavage occurs at the phosphate ester bond^{18,19}. Two mechanisms for the phosphate ester cleavage seem to be of major importance. The first is the elimination of phosphate from β -hydroxy radicals, e.g



This reaction has been studied by ESR techniques for dilute aqueous solutions²⁰. Similar results are obtained with glycerol-1-phosphate and glycerol-2-phosphate^{21,22}. Phosphate elimination only occurs if the position of the free radical is β to the phosphate and an OH group is in an α position to the free spin. The second important mechanism is the phosphate ester elimination from α radicals catalysed by oxidizing species²³. Here it is assumed that the α radical loses one electron under the influence of the oxidizing agent. The produced carbonium ion then hydrolyses and gives phosphate (equations 14, 15, 16)

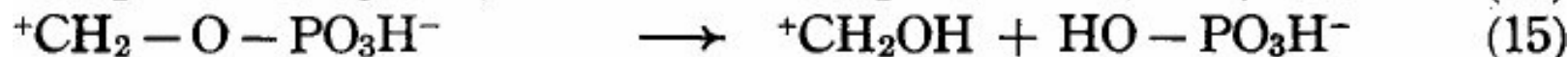
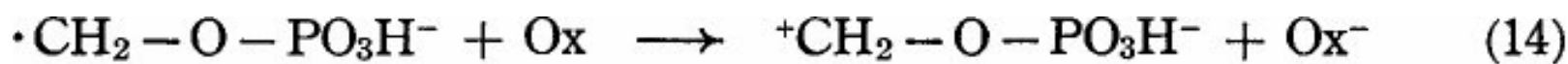

Oxidizing compounds which have the ability to initiate ester cleavage have been used as radiosensitizers. A compound which is a still better model is D-ribose-5-phosphate. Gamma-irradiation of this compound in dilute N₂O saturated solution leads to a number of products. One of these 5-deoxy-D-erythro-pentos-4-ulose, 1 in (equation 22)²⁴. 1 is most probably produced via the following mechanism which includes only reaction steps already well known:

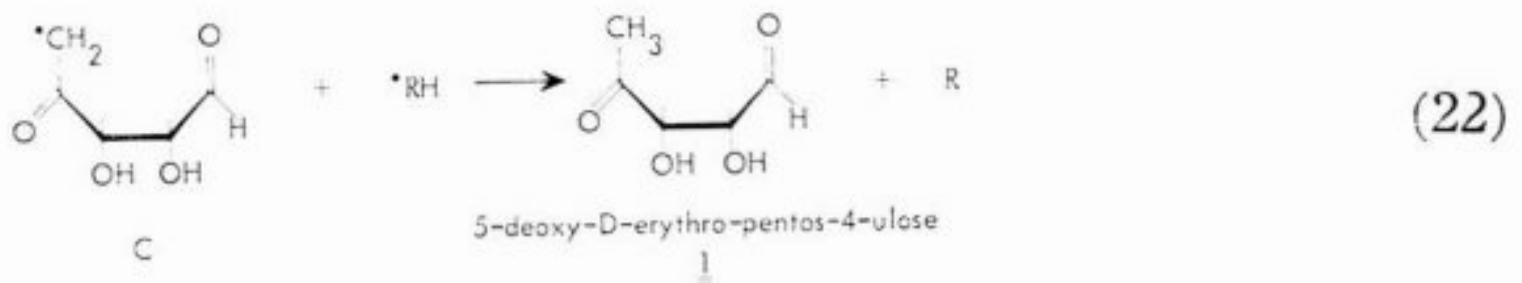
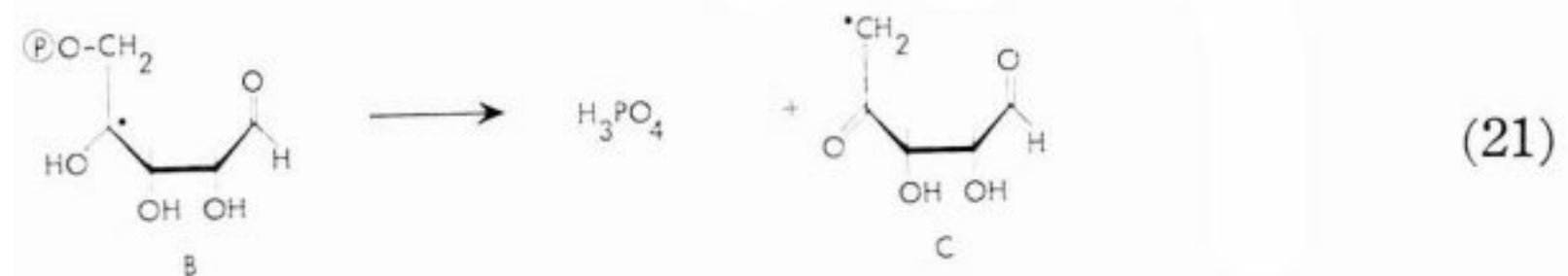
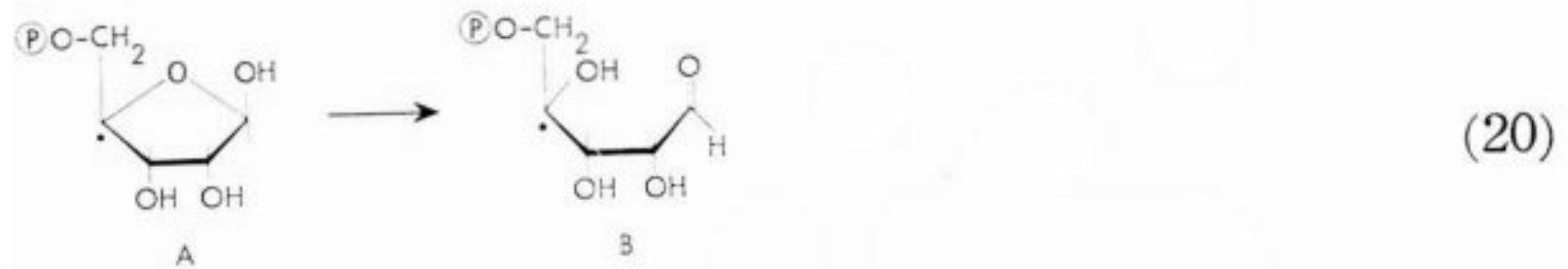
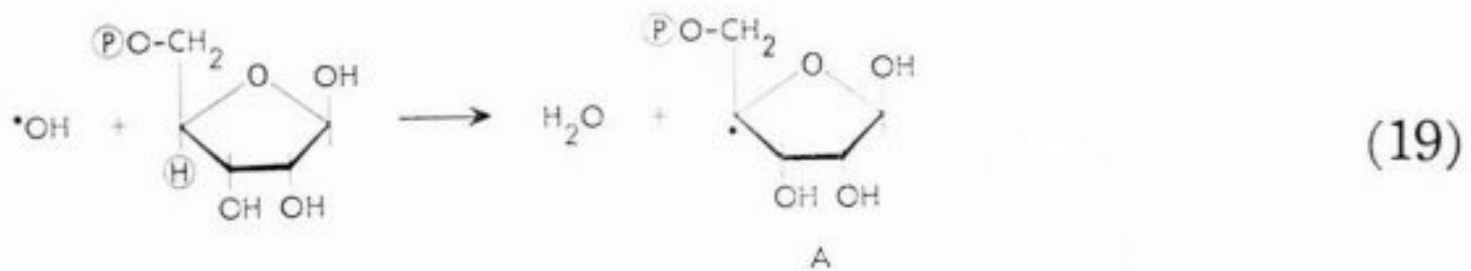
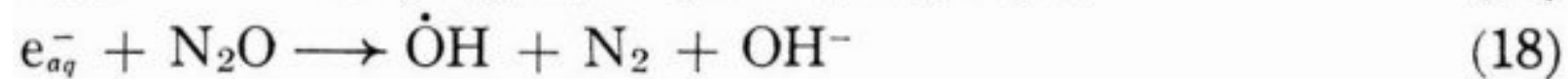
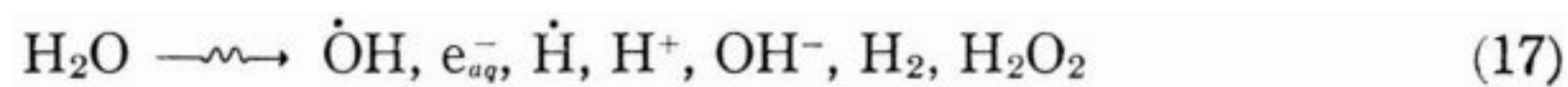

The cleavage of the phosphate ester bond occurs from a β -hydroxyl- β -radical (equation 21). However, this radical is formed by a ring opening reaction (equation 20) from the primary radical.

Cleavage of a glycosidic bond

As a model, cellobiose was chosen since this compound contains two glucose molecules linked together by a β glycosidic bond similar to cellulose itself. The mechanism leading to a splitting of the glycosidic bond in cellobiose may therefore give some indication of the way the cellulose may break under the influence of high energy radiation.

There are two possible methods of studying this problem. The first is to use dilute N_2O saturated solutions of cellobiose. In this case the interaction with OH radicals can be investigated. The second is

to irradiate the sugar in solid form as a powder or as a crystal.

(a) mechanism in dilute aqueous N_2O saturated solution

In the presence of N_2O only OH radicals (90%) and H atoms (10%) react with cellobiose. OH radicals and H atoms abstract H atoms from CH bonds and in this way produce a variety of C radicals²⁵. These radicals are transformed by a number of reactions, such as hydrolysis, rearrangements and water or carbon monoxide elimination. The transformed radicals disappear by disproportionation reactions.

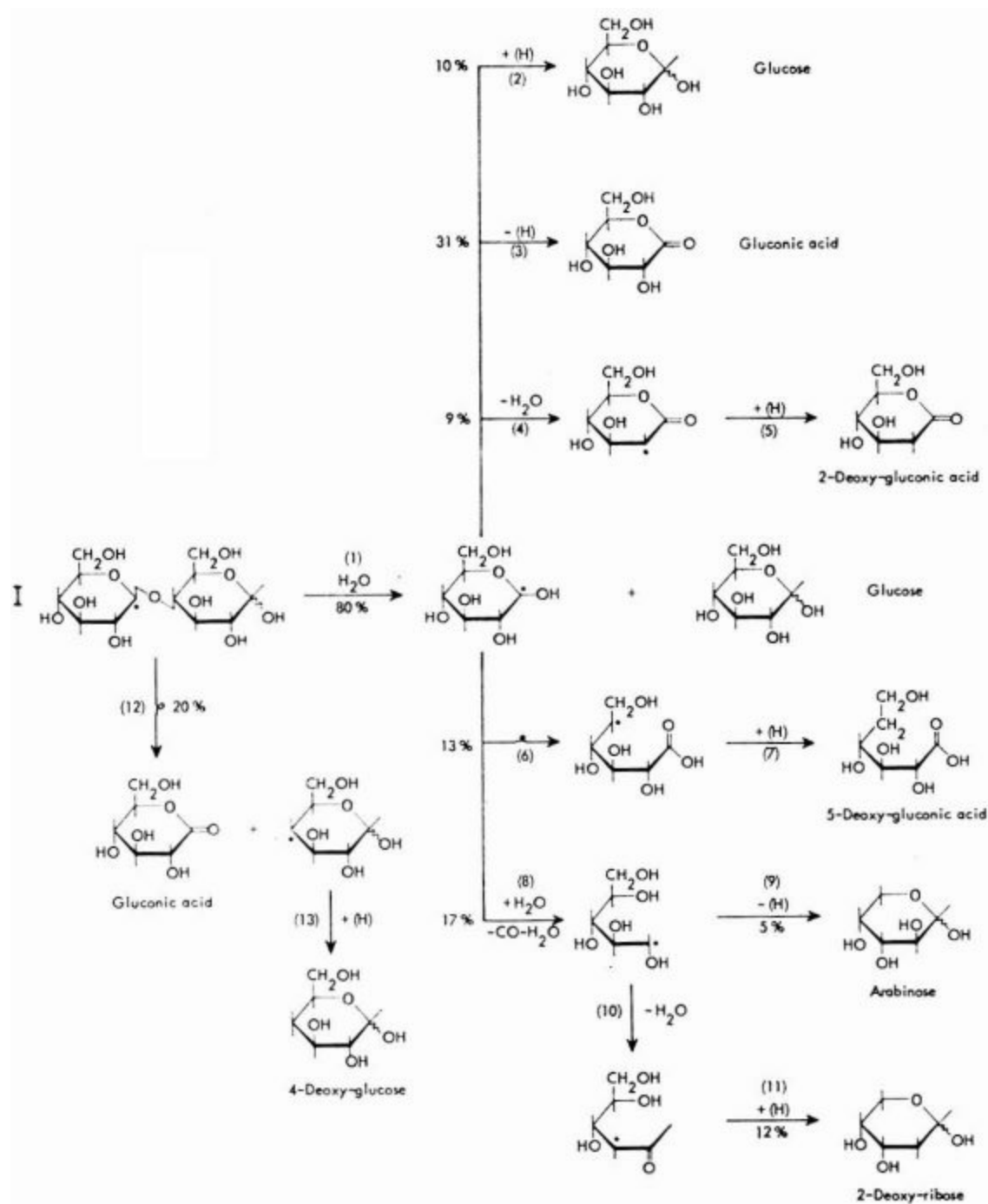

Figure 5. Reaction Scheme for Free Radical Reactions is Proposed which Suggests a Splitting of the Glycosidic Bond of Cellobiose in Aqueous Solution Following H Abstraction at C-1.

C_6 -products can only be observed when a cleavage of the glycosidic bond has occurred. It is sufficient, therefore, to isolate and identify the C_6 products. This has been done and the above

mechanism can explain 98% of all products if it is assumed that only hydrogen abstraction at C-1', C-4 and C-5' leads to a scission of the glycosidic linkage and all other radicals produced by OH and H attack on cellobiose do not show splitting of the glycosidic bond. As an example, the mechanism following H abstraction at C-1' is shown in Figure 5.

80% of the radical I hydrolyses and 20% splits directly into gluconic acid and a 4-glucose radical. The glucose radicals then are further transformed as shown in Figure 5. The details of the results, the G-values of the products, and two further reaction schemes are described in the original publication²⁶. Here it should be emphasized that it is possible nowadays to elucidate in great detail the free radical reactions leading to a splitting of the glycosidic bond in a molecule like cellobiose.

(b) mechanism in the crystalline state

The compound studied was α -lactose H_2O in the crystalline state²⁷. The products isolated (G values in brackets) are: galactonic acid lactone (4.5), 4-deoxy-glucone (4.5), 5-deoxy-lactobionic acid (40), 2-deoxylactobionic acid lactone (20). From these results it follows that two products must be formed by chain reactions. The reaction sequence which is now accepted starts with the assumption that free radicals are produced in the material. These radicals are able to initiate a free radical chain reaction which leads to the observed products.

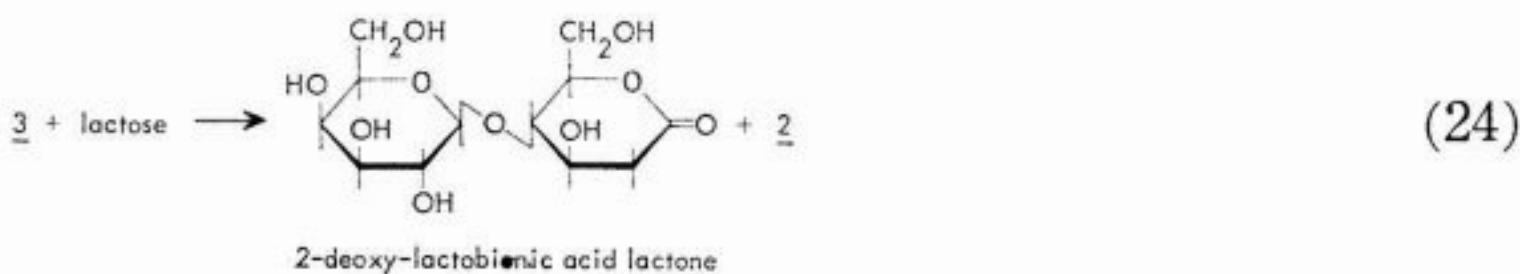
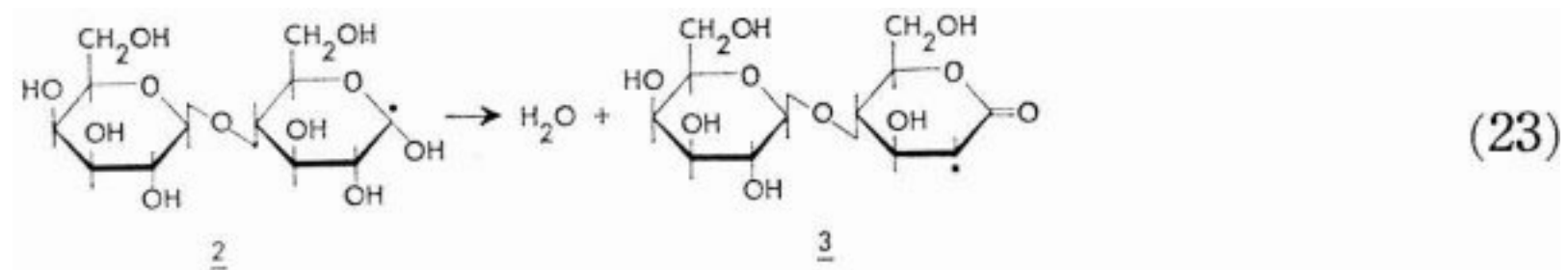

In this sequence an important step is the water elimination reaction.

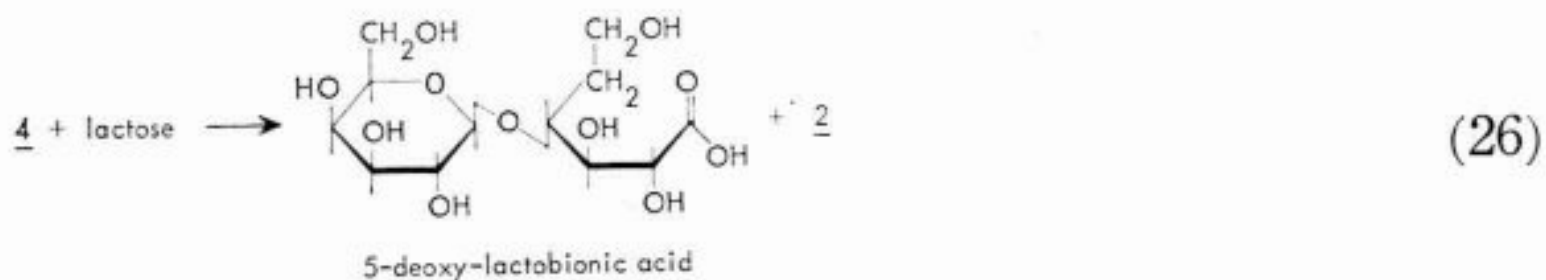
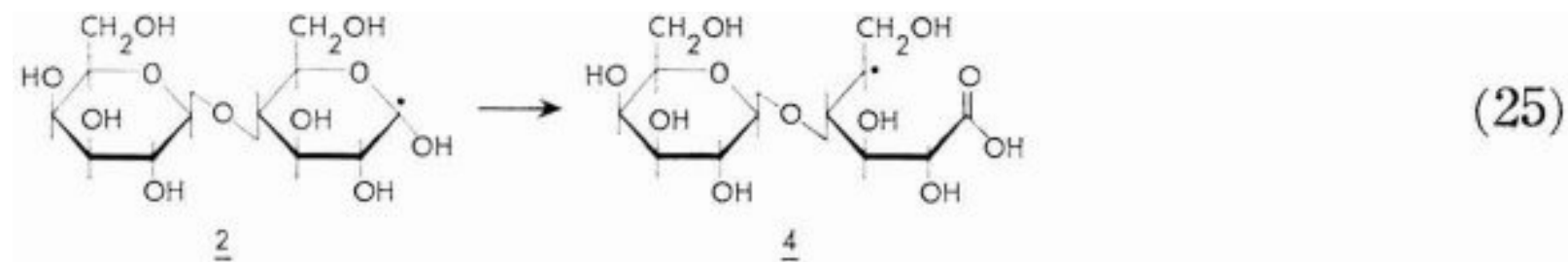

Reaction 25 shows a ring opening rearrangement as a transformation step.

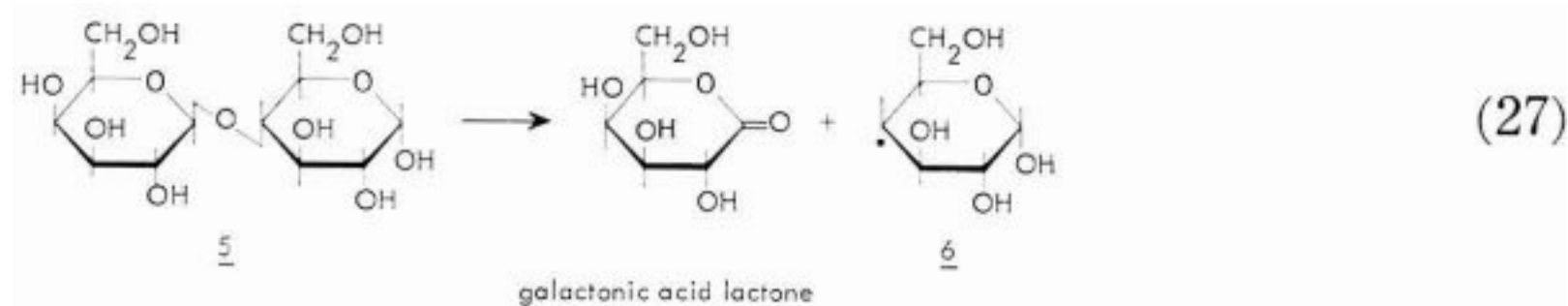

The step 27 shows that even in the crystalline state scission of the glycosidic bond can occur in free radical reactions.

References

1. A. Henglein, W. Schnabel, and G. Wendenburg, *Einführung in die Strahlenchemie*, Weinheim: Verl. Chemie 1969.
2. C. von Sonntag, *Z. Naturforsch.* **25b**, 654 (1970).
3. C. von Sonntag, *Fortschr. chem. Forsch.* **13**, 333 (1968).
4. G. R. Freeman, *Actions chim. biol. Rad.* **14**, 73 (1970).
5. L. G. Ackerman, R. A. Parson, and H. J. van der Linde, *J. Chem. Soc., Farad. Trans. I*, **68**, 1258 (1972).
6. R. H. Schuler and R. R. Kunz, *J. Phys. Chem.* **67**, 1004 (1963).
7. D. Sängner und C. von Sonntag, *Tetrahedron* **26**, 5489 (1970).
8. C. von Sonntag und W. Brünning, *Int. J. radiat. Phys. Chem.* **1**, 25 (1969).
9. C. von Sonntag, *Int. J. radiat. Phys. Chem.* **1**, 33 (1969).
10. J. Kroh and S. Karolczak, *Rad. Res. Rev.* **1**, 411 (1968).
11. G. R. Freeman, *Rad. Res. Rev.* **1**, 45 (1968).
12. R. L. Platzman, *Vortex* **23**, 372 (1962).

13. D. Schulte-Frohlinde, D. Sänger, and C. von Sonntag, *Z. Naturforsch.* **27b**, 205 (1972).
14. M. B. Robin and N. A. Kuebler, *J. Electron Spectrosc.* **1**, 12 (1972).
15. C. von Sonntag, *Z. Naturforsch.* **27b**, 41 (1972).
16. H.-P. Schuchmann, C. von Sonntag, and D. Schulte-Frohlinde, in preparation.
17. H. Dertinger und H. Jung: *Molekulare Strahlenbiologie*. Berlin: Springer 1969.
18. U. Hagen, A. Bopp, S. Carpy, and M. Ullrich, *Proc. 1. Europ. Biophys. Congr., Baden near Vienna*, **2**, 105 (1971).
19. A. Bopp and U. Hagen, *Biochim. Biophys. Acta* **209**, 320 (1970).
20. S. Steenken and D. Schulte-Frohlinde, unpublished results.
21. A. Samuni and P. Neta, *J. phys. Chem.* **77**, 2425 (1973).
22. S. Steenken, G. Behrens, and D. Schulte-Frohlinde, *Int. J. Radiat. Biol.*, **25**, 205 (1974).
23. J. A. Raleigh, C. L. Greenstock, and W. Kremers, *Int. J. Radiat. Biol.* **23**, 457 (1973).
24. L. Stelter, C. von Sonntag, and D. Schulte-Frohlinde, *Int. J. Radiat. Biol.*, in press.
25. M. Dizdaroglu and C. von Sonntag, *Z. Naturforsch.* **28b**, 635 (1973).
26. M. Dizdaroglu, C. von Sonntag, and D. Schulte-Frohlinde, in press.
27. C. von Sonntag and M. Dizdaroglu, *Z. Naturforsch.* **28b**, 367 (1973).
28. M. Dizdaroglu, C. von Sonntag, D. Schulte-Frohlinde, and W. V. Dahlhoff, *Liebigs Ann. Chem.* 1973, 1592.

Physical and Chemical Effects of Ionizing Radiations on Polymeric Systems

A. Chapiro

Laboratoire de Chimie Macromoléculaire sous Rayonnement 1, Place Aristide Briand, 92190 Meudon, France

The effects of ionizing radiations on polymers are briefly reviewed. Attention is focused on the range of doses which bring about alteration of properties in common plastics and rubbers. The chemical changes underlying radiation-induced

Abstract: *modifications are discussed with special emphasis on crosslinking, degradation and gas evolution. The role of trapped radicals in post-irradiation damage is described. The damaging action of oxidative degradation is considered in greater detail.*

Conclusions are drawn on the major modification of polymers under radiation sterilization conditions.

General Observations

When subjected to ionizing radiations all polymers suffer modifications of their properties which, for very high doses, result in a complete loss of their mechanical strength. The character of these modifications varies with the type of polymer involved. Thus, polyolefines turn hard and brittle at very high doses, rubbers harden and develop cracks, Teflon™ crumbles into powder, polyisobutylene is gradually converted to a sticky and thereafter to an oily fluid. The response to radiation dose also depends to a large extent on the polymer under examination. The elastic properties of rubbers are strongly affected by 10^7 rads, silicone rubbers being more stable. Poly (vinyl chloride) subjected to 10^7 - 10^8 rads turns black but its mechanical strength may still remain almost unchanged. (The behaviour of this polymer is particularly sensitive to its stabilizers). Polymers such as poly (methyl methacrylate) (Plexiglas™, Perspex™), Teflon™ or cellulosic materials are severely damaged by doses of 10^7 - 10^8 rads. In contrast, polystyrene, phenolics, polyphenylene oxide (PPO) and other aromatic polymers may withstand doses as high as 10^9 rads with only minor changes of their properties. The chemical changes brought about by radiations which underlie these physical modifications are limited to a few basic processes: gas evolution, crosslinking and degradation. The same chemical changes occur in low molecular weight substances under irradiation but their effects are more dramatic in polymers because of the macromolecular structure of these materials.

It should be emphasized that common plastics are definitely not pure chemicals. They contain various additives such as plasticizers, lubricants, stabilizers, etc... and these may strongly influence the response of a given plastic to ionizing radiations. In an ideal situation plastics which are intended for use in radiation fields should be specifically compounded for this purpose. Such a situation is not met today with the exception of a few specific cases.

Oxygen plays a major role in all free radical reactions and its participation in radiation-induced transformation of polymers may become the dominant factor.

Crosslinking Versus Degradation

Crosslinking

Crosslinking is the process which binds together two polymeric chains. It can be represented by the

following reaction scheme where $\begin{array}{c} \text{H} \\ | \\ \text{~~~~~} \end{array}$ denotes a macromolecule with a side hydrogen atom H. Radiolysis of polymer molecule:

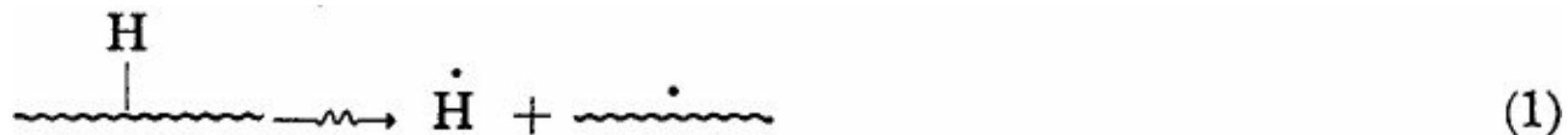

Hydrogen abstraction from a neighbour molecule:

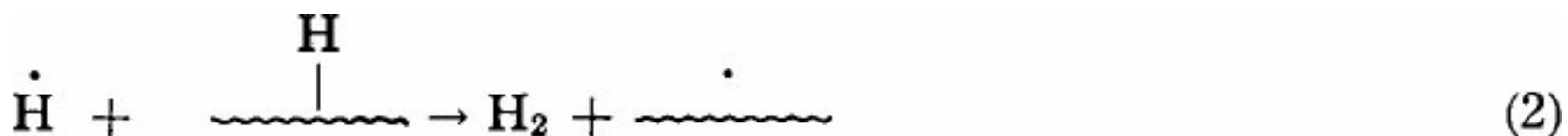

Combination of two polymeric radicals:



As this process goes on, more and more macromolecules are bound together until a tridimensional network arises

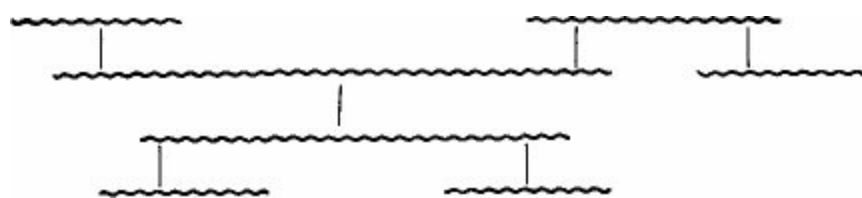

crosslinked polymer

At this point the original polymer (assumed to be a thermoplastic material) no longer melts nor dissolves in its conventional solvents. It has become crosslinked (or “vulcanized”). If the original polymer is a gum, crosslinking imparts to it rubber elasticity, which means that after being subjected to a deformation by external stress the sample recovers its original shape as soon as the stress is released.

If the original polymer is crystalline or in the glassy state, moderate crosslinking hardly affects its physical properties. Upon further irradiation, however, the density of crosslinks may increase to such an extent that segmental motion becomes strongly reduced in the polymer, this brings about increased hardness and brittleness. Thus polyethylene subjected to doses of 10^9 - 10^{10} rads turns into a dark-tinted, transparent glass which is hard and brittle.

Crosslinking yields vary widely depending on the polymer under consideration. Table I summarizes G values of crosslinking for a variety of polymers.

Table I. — Yields of crosslinking (c. 1.) and ratio β/α of degradation to crosslinking probabilities for polymers of the “crosslinking type”

Polymer	G (c. 1.) at 20°C	β/α
Polyethylene	2.0	0.2 — 0.3
Polypropylene	0.6	0.8 — 1.0
Polystyrene	0.04 — 0.06	0 — 0.2
Natural rubber	1.3	0.14
Polybutadiene	2.0	
Polyacrylonitrile	1.4	
Poly(methyl acrylate)	0.5 — 1.1	0.17
Poly(vinyl chloride)	0.2 — 0.5	
Poly(vinyl acetate)	0.28	0.1
Poly(dimethylsiloxane)	2.5	0
Poly(methylphenylsiloxane)	0.8	
Polyamides	0.3	

Degradation

The term *degradation* is taken here in its molecular sense; it is meant to designate the process which leads to the scission of polymeric chains:

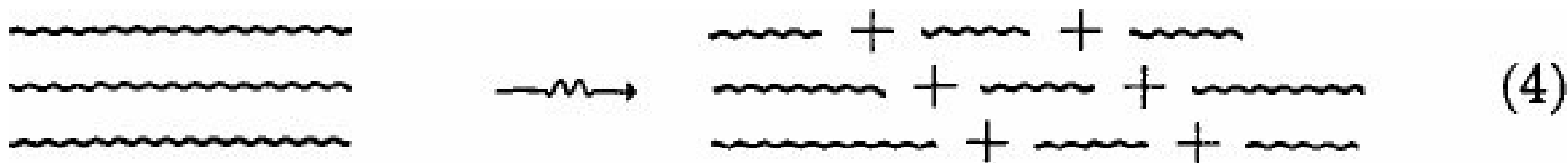

Such chain scissions occur in most polymers even though the net result may be one of crosslinking. The last column in Table I lists the values of β/α which represent the ratio of degradation to crosslinking probabilities. It can be seen that β/α varies within a broad range, being almost unity for propylene and practically zero for polysiloxanes. If β/α is higher than unity the net effect of irradiation is degradation of the polymer. Table II lists the G values of chain scissions for polymers of the “degrading type”. It should be emphasized that, as far as physical and mechanical properties are concerned, radiation damage occurs for both types of polymers and there is no direct correlation between “degradation” of mechanical properties and molecular chain scission.

Table II. — Yields of degradation for polymers of the “degrading type”

Polymer	G (scissions) at 20°C
Polyisobutylene	3.0
Poly(methyl methacrylate)	1.9
Cellulose	10.0
Poly(α — methylstyrene)	0.25

Other Chemical Changes

Gas evolution

Polymers, as other organic substances, evolve gases under irradiation. The major product is usually

hydrogen together with low molecular weight hydrocarbons (methane, ethane). As a general rule, side-chains are selectively ruptured. Thus methane arises during irradiation of polypropylene and polyisobutylene, carbon monoxide and dioxide and methane are found among the gaseous products from Plexiglas™ (Perspex™). Chlorine-containing polymers yield hydrogen chloride which may cause severe corrosion to metallic parts placed in contact with the irradiated plastic. This is particularly true for poly (vinyl chloride) (PVC) or poly(vinylidene chloride) (Saran™), two plastics which should only be placed in radiation fields if loaded with sufficient amounts of effective stabilizers. Table III lists the gases evolved from common polymers under irradiation.

Table III. — Gases evolved from polymers under irradiation

Polymer	Monomeric unit	Gases evolved
Polyethylene	$-\text{CH}_2 - \text{CH}_2 -$	H_2
Polybutadiene	$-\text{CH}_2 - \text{CH} = \text{CH} - \text{CH}_2 -$	H_2
Polypropylene	$\begin{array}{c} \text{CH}_3 \\ \\ -\text{CH} - \text{CH}_2 - \end{array}$	H_2, CH_4
Polyisobutylene	$\begin{array}{c} \text{CH}_3 \\ \\ -\text{C} - \text{CH}_2 - \end{array}$	H_2, CH_4
Polybutene	$\begin{array}{c} \text{CH}_3 \\ \\ -\text{CH} - \text{CH}_2 - \end{array}$	$\text{H}_2, \text{C}_2\text{H}_6$
Poly(methyl methacrylate)	$\begin{array}{c} \text{C}_2\text{H}_5 \\ \text{CH}_3 \\ \\ -\text{C} - \text{CH}_2 - \\ \\ \text{COOCH}_3 \end{array}$	$\text{H}_2, \text{CH}_4, \text{CO}, \text{CO}_2$
Poly (vinyl chloride)	$\begin{array}{c} \text{Cl} \\ \\ -\text{CH} - \text{CH}_2 - \\ \\ \text{Cl} \end{array}$	HCl
Poly(vinylidene chloride)	$\begin{array}{c} \text{Cl} \\ \\ -\text{C} - \text{CH}_2 - \\ \\ \text{Cl} \end{array}$	HCl

Trapped radicals

Free radicals created by irradiation in solid polymers are immobilized and may remain trapped for a considerable length of time. Those radicals are responsible for post-irradiation “aging” of many plastics and their role in sterilization should not be neglected. After irradiation, oxygen diffuses into the polymer and may further induce oxidative degradation (see below). The main factor governing the trapping of radicals is the physical state of the irradiated polymer. In *rubbery polymers* the mobility of radicals is fairly large and their survival time after irradiation accordingly low. In contrast, radicals are effectively trapped in polymers below their *glass transition temperature* (T_g). This is the case for many common plastics at room temperature, e.g. for polystyrene, Plexiglas™ (Perspex™), PVC, etc... The mobility of radicals is also strongly reduced in *crystalline regions* of the polymer and this accounts for

the presence of long lived radicals in polymers such as polyethylene, cellulose, Teflon™, etc... Table IV summarizes the behaviour of various plastics with respect to radical trapping.

Table IV. — Trapped radicals in polymers irradiated at room temperature

No trapping	Long lived radicals	
	Glassy polymers	Crystalline polymers
Rubbery polymers		
Natural and artificial rubbers	Polystyrene	Polyethylene
Silicone rubbers	Plexiglas™ (Perspex™)	Cellulose
Plasticized polymers	PVC	Teflon™

Influence of oxygen

Under irradiation in air, most polymers suffer **oxidative degradation**. This reaction leads to chain scission and takes place in any polymer, including polymers of the “crosslinking type”. The following sequence of reactions schematically represents the process in the case of polyethylene.

Radiolysis of polyethylene:

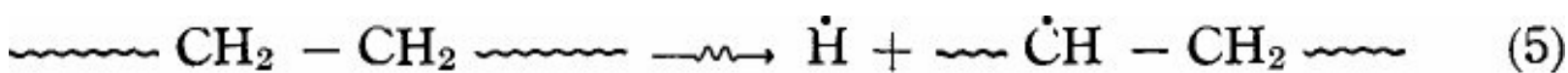

Addition of oxygen to the polymeric radical:

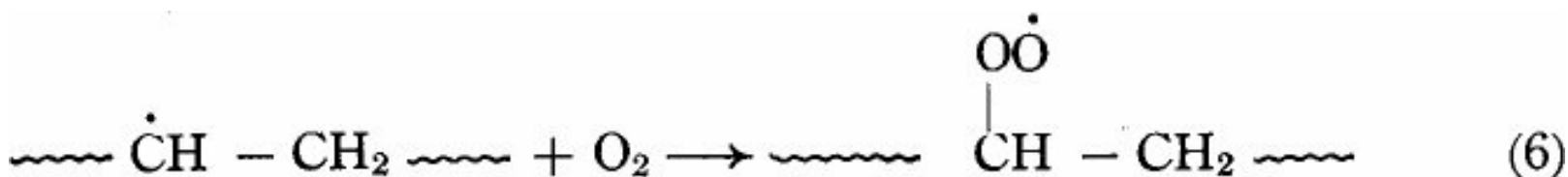

Rearrangement of the peroxidic radical:

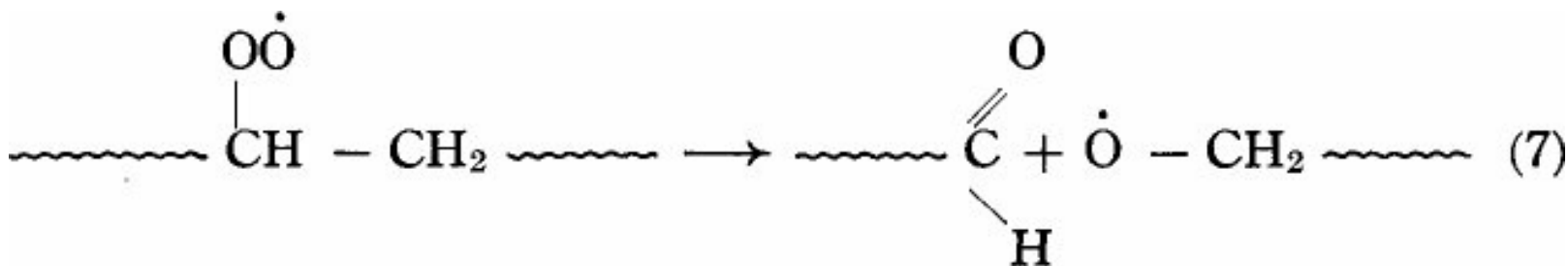

Hydrogen abstraction from a neighbour molecule:

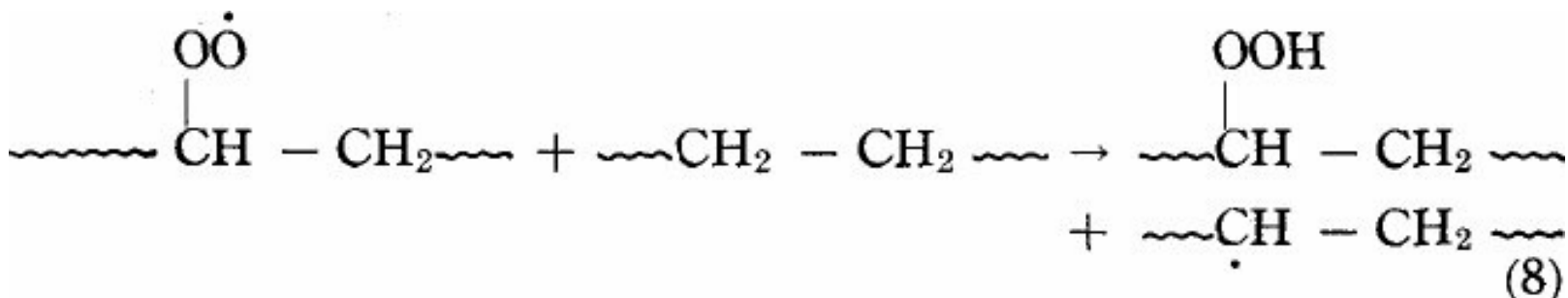

The hydroperoxides formed in reaction (8) accumulate at low temperature. They decompose either on

further irradiation or on subsequent storage:

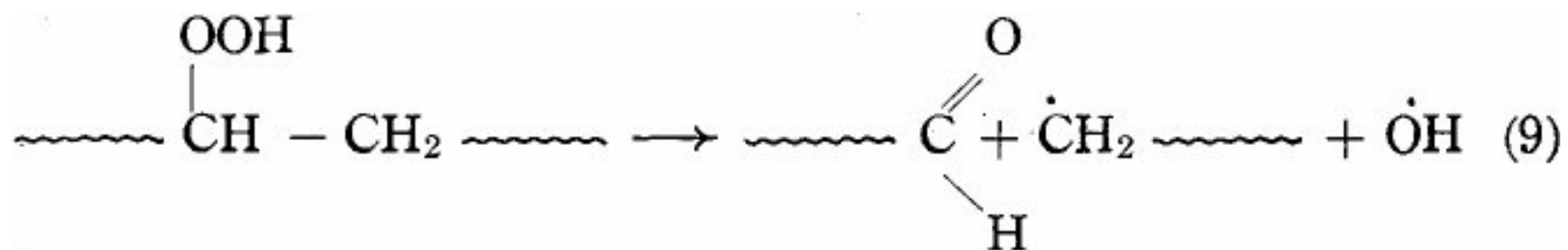

It can be seen that reactions (7) and (9) both lead to chain scission. It follows that even polymers of the “crosslinking type” may become degraded under irradiation in air. Oxidative degradation is particularly severe for polymers in a highly divided state, e.g. fibers, powder, thin films etc...., in which case oxygen easily diffuses into the polymer. In bulky pieces of glassy or crystalline polymers the supply of oxygen is slow and oxidative degradation then only becomes noticeable if the radiation dose-rate is low. *This slow diffusion of oxygen accounts for dose-rate effects and particularly for differences in behavior under gamma or electron-irradiation.*

If the radicals generated in reaction (5) remain trapped in the polymer the sequence of reactions (6) to (9) may take place slowly after irradiation, sometimes over a considerable period of time and this accounts for post-irradiation damage observed with many common plastics. Such damaging effects of oxygen are eliminated if irradiation (and storage after irradiation) takes place in an inert atmosphere. Post-irradiation damage induced by trapped radicals may be minimized by an appropriate thermal treatment in which the polymer is heated to the vicinity of its T_g (or of its crystalline melting temperature). The radicals then acquire a high enough mobility and rapidly disappear by combination.

Irradiation of Polymers for Sterilization Purposes

It appears from the above that ionizing radiations produce permanent chemical transformations in all polymers and thereby alter the physical properties of common plastics. The main cause of radiation damage being oxidative degradation, it would seem appropriate to carry out irradiation in an inert atmosphere. Such a procedure does not apply, however, to sterilization. Indeed, radiation damage to living cells results from a sequence of reactions similar to that represented by reactions (5) to (9). Thus, irradiation in an inert atmosphere would not only “protect” the plastic but also protect the germs and therefore lead to much higher sterilization doses. It follows that radiation sterilization must by necessity be carried out in air and its efficiency could even be increased in an oxygen enriched atmosphere. Fortunately, the doses required for sterilization are small enough not to affect seriously most polymers. The latter should be further “protected” whenever possible, by incorporating in their formulation a sufficient amount of properly selected stabilizers. Optimum results would be obtained by a thorough determination of special formulations for polymers to be exposed to ionizing radiations. Finally, post-irradiation damage may become a serious problem for crystalline or glassy polymers in which large populations of trapped radicals may induce slow degradation processes during storage after irradiation. In such an event, a post-irradiation heat treatment is advisable; this would eliminate the trapped radicals and could eventually increase the efficiency of sterilization.

References

The pertinent references to the literature are found in:

Chapiro, A. (1962), *Radiation Chemistry of Polymeric Systems*, Interscience, a division of John Wiley & Sons, New York.

Chapiro, A. (1969), *Radiation-Induced Reactions* in *Encyclopedia of Polymer Science and Technology*, John & Sons, vol. **11**, New York.

Physical and Chemical Effects of Ionizing Radiation on Plastic Films, Laminates and Packaging Materials

D. W. Plester

Imperial Chemical Industries Ltd., Plastics Division, Welwyn Garden City, England

A functional package is essential to ensure that sterile contents are provided at the moment of use. The package must not be adversely affected by the sterilization process. Because of their excellent range of properties plastics have a large and increasing place in packaging both in film form and as shaped three-dimensional packages.

All plastics are affected by ionizing radiation accompanied by a deterioration in their valuable characteristics. Many, however, are resistant to the usual sterilization dose of 2.5 Mrad. Among these are polyethylene which is by far the most widely used material, and polystyrene. There are a few which are so seriously altered by a single dose that they are unsuited to this sterilization technique. In between are several important products whose resistance is borderline. This group includes poly(vinyl chloride) and polypropylene and it is established that the incorporation of appropriate additives significantly reduces the undesirable radiation effects. While further improvements are still needed it is suggested that these can be achieved with the adaptation of existing technology.

Packaging Plastics

Sterilization is a waste of effort without a functional package that will ensure sterile contents are delivered at the time and place of use. This self-evident truth has been often stated before but is sufficiently important to stress again as an introduction to a consideration of one aspect of the problem, namely the effects of radiation on plastic packaging materials.

There is a wide variety of plastics used for packaging although a comparative few dominate the market. While details are not available on the products employed in the medical area, as an illustration Figure 1 shows the proportions of different plastics used in the UK for all packaging. Five materials together make 97% of the total and of these by far the most important is low density polyethylene. Some of the products used only in minor quantities are valuable from the performance aspect. For example, poly(vinylidene chloride), poly(ethylene terephthalate) and nylon have good barrier properties and thermosetting plastics have characteristics suited to the making of closures.

Proportions of Plastics (By Weight) Used in Packaging in the UK (1971-1972)

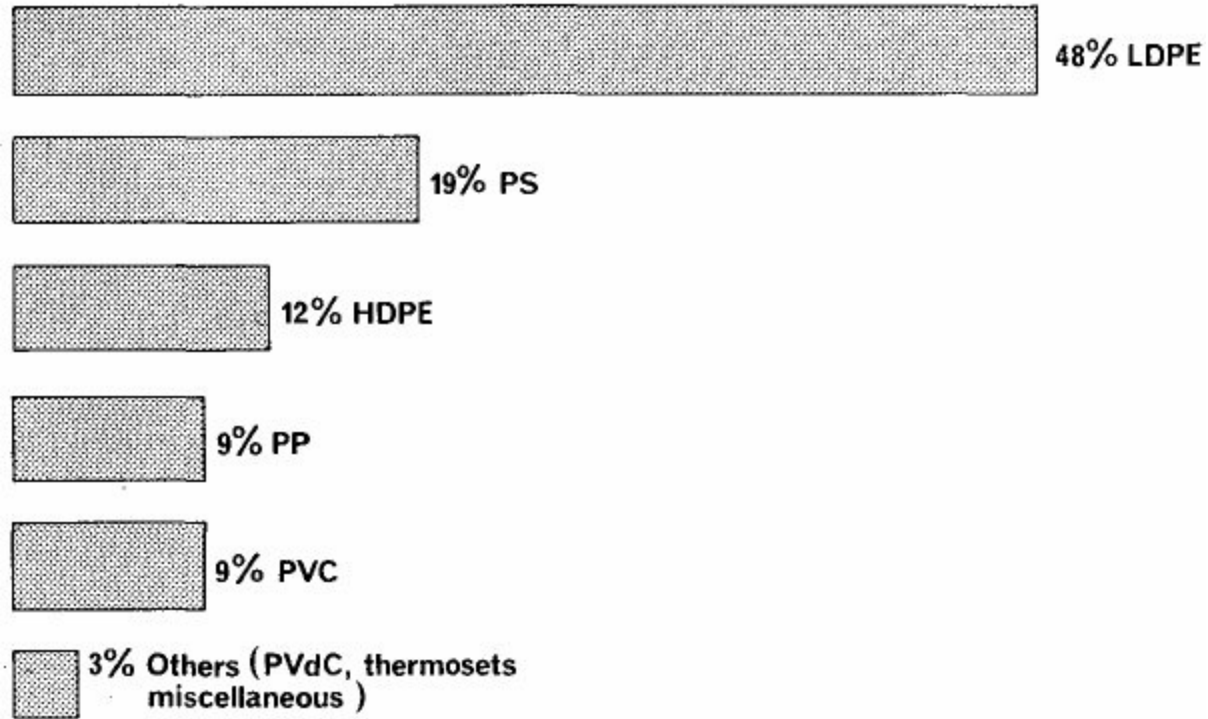

Figure 1. Proportions of plastics (by weight) used in packaging in the UK (1971-72).

Figure 2 refers to the form of the package, again this is UK data, and illustrates the percentages of various types commonly used. The two main forms are often broadly classified as two-dimensional and three-dimensional. Basically, films and products derived from films are designed to make flexible two-dimensional forms of packaging although, when filled, some of these may in fact be rigid and three-dimensional, relying on their contents to maintain rigidity. Coatings are usually associated with films but may in some cases be on rigid substrates. In general, however, the two-dimensional flexible package occupies 50 per cent of the field. The other main forms use the more important techniques available for plastics fabricating: thermoforming, blow molding and injection molding. The key to the success of plastics in packaging has been their versatility so that penetration of the field has been on a broad front. The obvious functions of a package are to provide mechanical protection and barrier protection to preserve the contents but it must also be economic, be capable of being handled by the prevailing distribution system and not least it must be attractive. The form and appearance of the package is unavoidably associated with its contents. While this is clearly applicable to food or even more to cosmetic packing, its importance in the medical and pharmaceutical areas is undeniable too. An unattractive package makes the user immediately doubtful of the quality of the contents.

Main Forms of Plastics Packaging in Use in the UK (1971-1972)

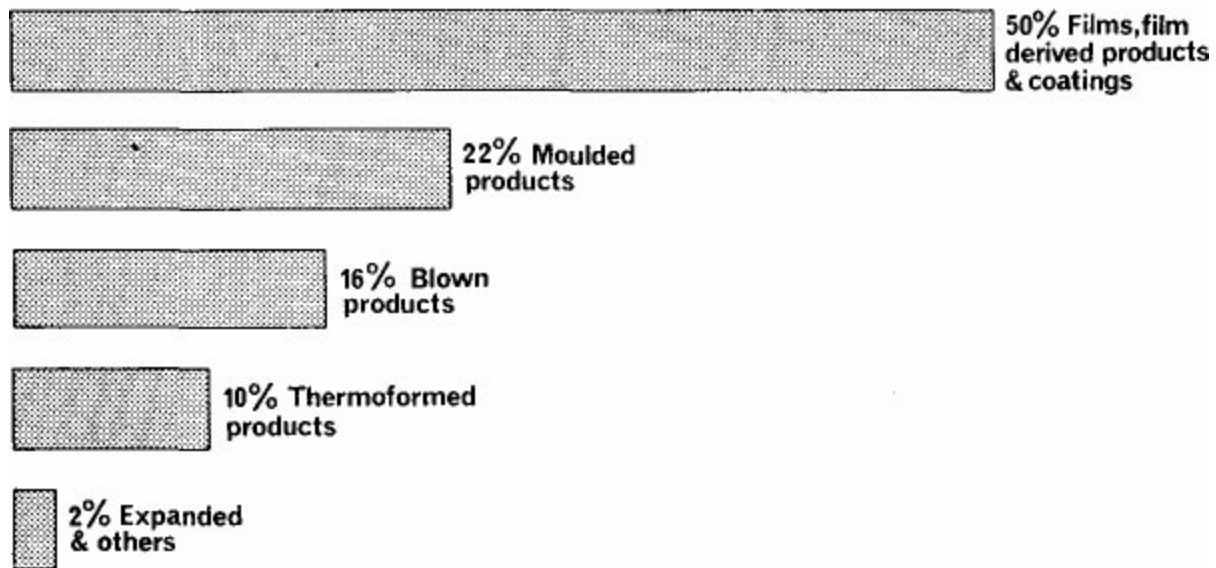

Figure 2. Main forms of plastics packaging in use in the UK (1971-72).

Effects of Radiation

With these requirements in mind attention can now be turned to the changes that ionizing radiation brings about in plastics. Of particular interest is the result of a single sterilization dose since it can be assumed that all packaging is disposable.

The term “plastics” is usually applied to synthetic organic polymers which at some stage in their production are capable of being shaped and subsequently retaining that shape. The polymer molecules are made up of a large variable number of repeating units and may be straight or branched, randomly or regularly. The arrangement of molecules in the mass can be ordered or disordered giving zones of high or low crystallinity. Small amounts of other ingredients are usually incorporated to aid processing or to improve technical properties.

All plastics are affected by radiation but vary greatly in the type of effect and the sizes of the dose necessary to produce a significant change. Gas evolution, polymerization, crosslinking, degradation and double bond formation have all been observed. The polymer molecules may be broken into smaller fragments as a result of chain scission, or crosslinking may bring about the formation of still larger molecules. Polymers preferentially crosslink or degrade depending on their chemical structure. Both processes may occur simultaneously although usually one predominates. Owing to their high molecular weight plastics may undergo quite large changes in physical properties as a result of only minor chemical modifications. As the chemical reactions are taking place in a solid medium, and an ill-defined one, it is difficult to predict behaviour on a theoretical basis.

The observed effects on properties most importantly involve mechanical characteristics. Processes causing an increase in molecular weight, such as polymerization or crosslinking, lower the mobility of molecules within the mass. This tends to reduce creep, increase brittleness and hardness but may or may not raise the tensile strength depending on the normal mechanism of tensile breaking.

The lowering of molecular weight on the other hand resulting from radiation induced degradation

detracts from most of the valuable properties normally associated with plastics. Tensile, impact and shear strengths are all reduced and so too is the elongation. Often embrittlement occurs even though the material may have become softer. Crystallinity can increase after degradation, there being less restraint on the ordering of the shortened molecules, and this is associated with a rise in specific gravity.

Another obvious effect of radiation on many plastics is the appearance of coloration probably due to the formation of double-bond sequences. Materials turn yellow or brown, in some cases at high doses becoming opaque. The extent and amount of color may alter on storage and indeed many of the effects noted continue to occur for some time after the exposure to radiation has ceased.

The effects of radiation sterilization on plastics have been more fully surveyed elsewhere^{1,2} and other sources provide information on mechanisms and behaviour at more extreme exposures^{1,2,3,4,5,6}.

Figure 3 illustrates the effects radiation has on selected properties of some of the more common plastics and it is apparent that some plastics are substantially less affected than others. Polyethylene exhibits no significant change in the properties listed below 8 Mrad and is not greatly affected even at 100 Mrad. Polytetrafluoroethylene, on the other hand, alters by more than 50% in all but the elastic modulus at the normal sterilization dose of 2.5 Mrad. The doses at which various properties are affected may vary widely: for example the impact strength of nylon decreases by 50 per cent on exposure to 20 Mrad whereas the tensile strength is little changed after 100 Mrad. Not all properties have equal importance in any particular application. The elongation characteristics of phenol formaldehyde, for instance, are of little significance. Ignoring this effect the material is virtually as resistant to radiation as polyethylene.

Effect of Radiation on Properties of Plastics

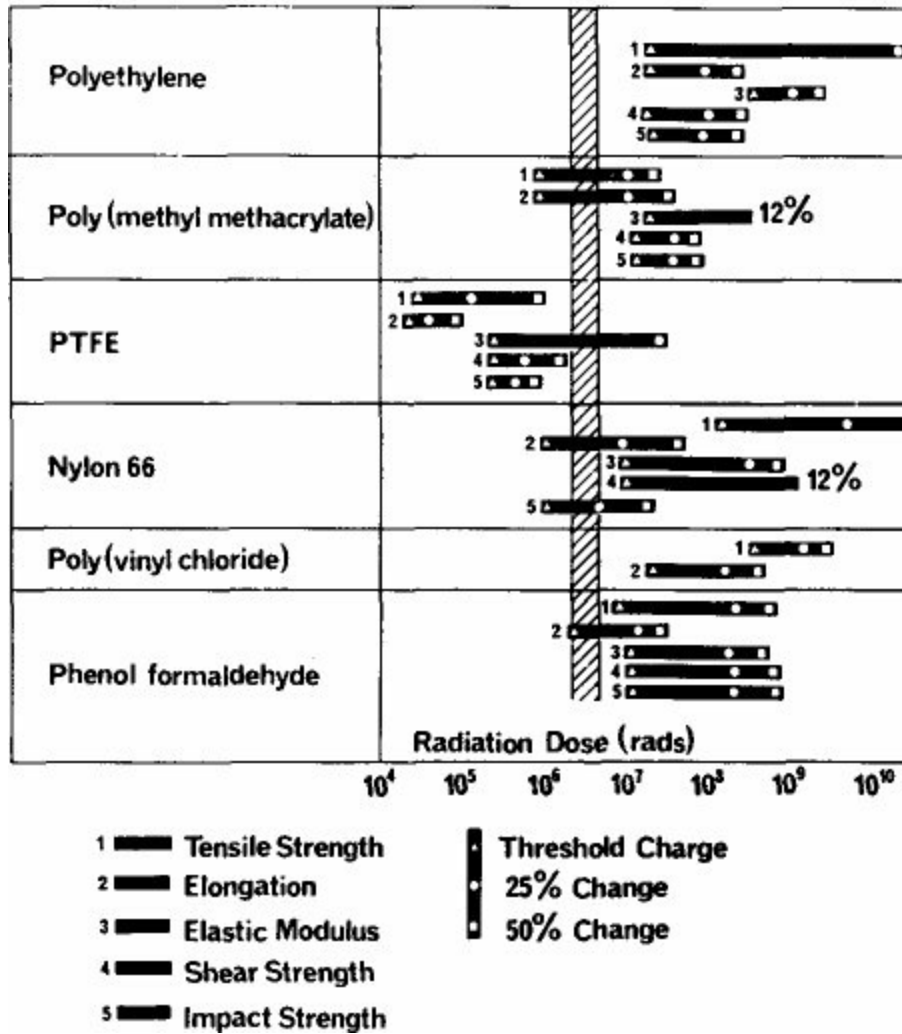

Figure 3. Effect of radiation on properties of plastics.

One requirement of all medical packages not so far dealt with is inertness. The package must not donate to its contents any substance in a quantity which will introduce a toxic hazard or which will affect the nature of the contents. In general plastics are remarkably inert and grades of most materials suitable for medical packaging are available. Nonetheless analytical techniques are sufficiently sensitive nowadays to detect that minute traces are extractable from all packaging whether it be plastics, glass or metals. Measurements have been made to see whether exposure of plastics to radiation affects the amount of the extractable fraction. Figure 4 illustrates the effect on the total extraction from various plastics by pentane. This is an arbitrary test but the findings are of interest and similar behaviour has been observed for a number of other organic solvents. The effect of radiation is clearly a reduction in the size of the extractable fraction.

Effect of Radiation on Extractable Fraction in Pentane

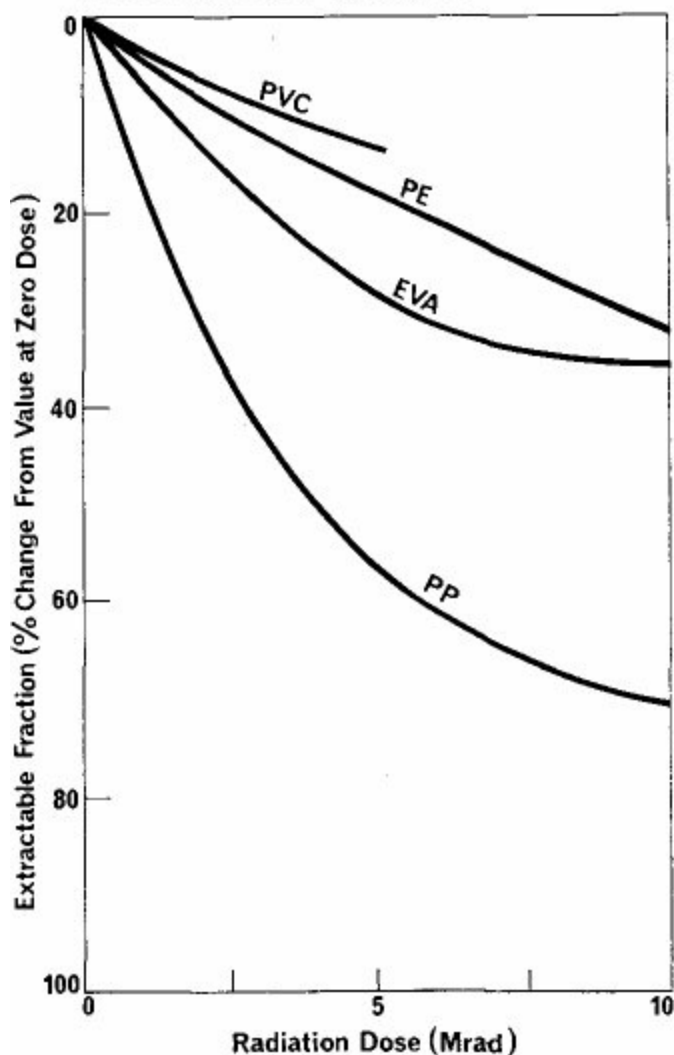

Figure 4. Effect of radiation on the pentane-extractable fraction of polyethylene, polypropylene, EVA and PVC.

It is convenient to group plastic packaging materials according to how well they withstand exposure to a single 2.5 Mrad radiation sterilization dose. Table I includes three categories: those materials with good resistance and largely unaffected until much higher dose levels, those with moderate resistance in which changes do occur but usually small enough to be acceptable, and those which are unsuited to this form of sterilization.

Performance Improvements

By and large it is reasonable to dismiss the first group from further consideration here because the materials there do not pose any problems in sterilizing, and to discard the third for which irradiation cannot be used. The middle group is the interesting one. It is with those borderline plastics that it can be rewarding to devise ways of making small improvements in performance to convert marginal performance to good acceptability. This is especially relevant as the group includes two products, polyvinyl chloride and polypropylene, whose properties make them important in the packaging area⁷.

Table I. — Radiation Resistance of Packaging Plastics

Single user license provided by AAMI. Further copying, networking, and distribution prohibited.

Resistance

Material

Common Packaging Uses

Good	Polyethylene, HD and LD	Film, bags, sachets, moulded containers, squeeze tubes, closures, also laminates
Suitable for several sterilization doses	Polystyrene	Thermoformed containers, injection molded containers
	Ethylene/vinyl acetate copolymer	Film wraps
	Poly(ethylene terephthalate)	Bags, often used in laminates
	Phenol formaldehyde	Closures
Moderate	Polyvinyl chloride; rigid	Rigid: molded containers, thermoformed containers
	plasticised	Flexible: sachets, bags, closure seals
Usually suitable for one sterilization dose	Polypropylene	Molded containers, foil, films often in film laminates
	Nylon	Bags, often in film laminates
Poor	Poly(vinylidene chloride) Vinyl chloride/acetate copolymer	Laminates, films
Unsuitable for radiation sterilization	Acetal copolymers	Thermoformed containers Aerosol containers

Consider first polyvinyl chloride (PVC) whose excellent range of properties, particularly cost, inertness and transparency all account for its wide use. From the rigid form for example blow molding containers are made for pharmaceutical products while the flexible (plasticised) type is used for sachets, blood bags and transfusion and infusion equipment. As already mentioned, a radiation dose of 15 Mrad causes no significant change in mechanical properties of PVC but discoloration does occur at around the normal sterilization dose. This is not only aesthetically displeasing but makes the user doubtful of the acceptability of the product suspecting it to be of poor quality. A requirement therefore exists to reduce the tendency of PVC to discolor and some improvements have already been made. While the problem is yet to be fully solved a brief consideration of some factors involved is relevant and may point towards a more complete answer.

Pure polyvinyl chloride is highly unstable thermally, so much so that it is impossible to fabricate articles from it by conventional thermoplastic processes without unacceptable degradation. On heating dehydrochlorination occurs resulting in conjugated unsaturation.

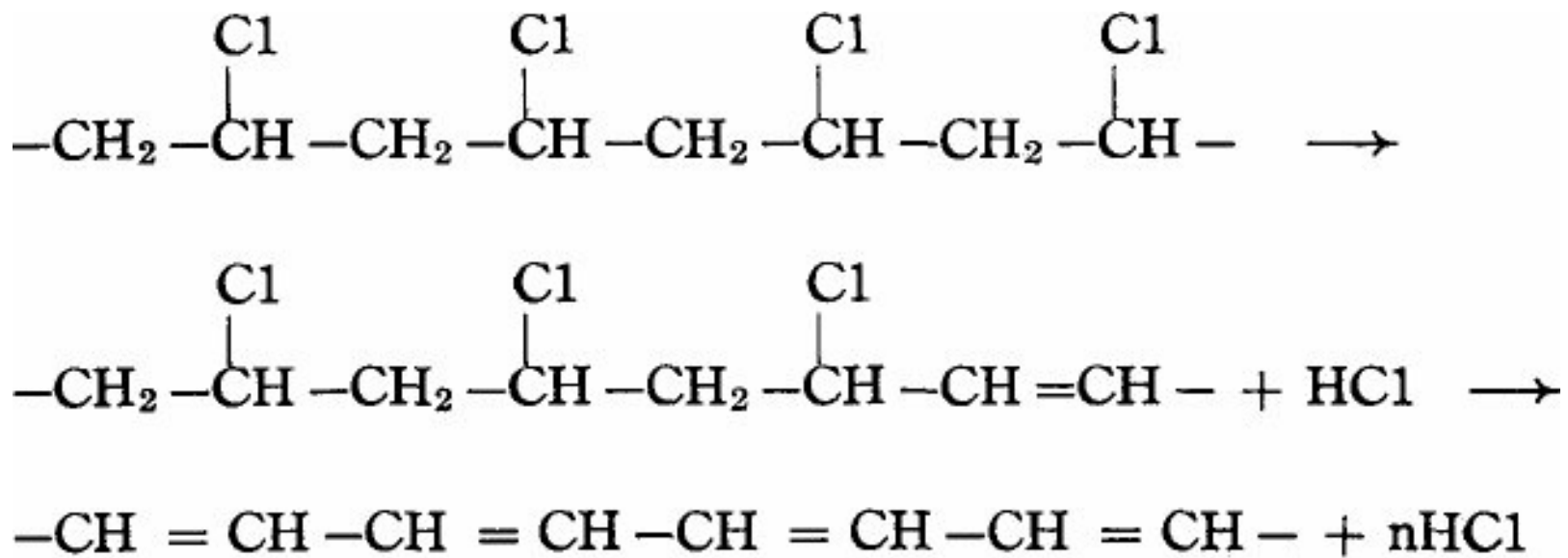

Discoloration increases with the number of conjugated polyene sequences and changes in character with their length. In commercial practice such thermal degradation is retarded by the incorporation of substances known as stabilizers, it is normal to use a number of these together to benefit from synergistic interaction.

The mechanism of stabilization is very complex but primary stabilizers are considered to act by substituting a stable group for an unstable chlorine atom in the molecule. For example a zinc soap replaces the chlorine with an ester group:

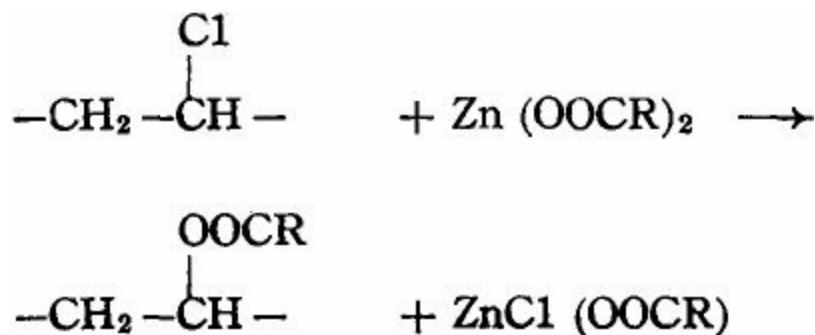

On their own such substances are very inefficient stabilizers, probably because the metal chlorides formed catalyze the further decomposition of the polymer. Although the addition of, say, zinc laurate gives a much better initial color to PVC there is a catastrophic darkening after a short time at elevated temperature; more so than with no stabilizer at all present. Secondary stabilizers although fairly ineffective on their own especially for providing initial color can to a large extent delay the very rapid change that occurs with metal soaps alone. Epoxidized fatty oils for example have this effect. So do certain organic phosphites and a number of other chemicals. Even more dramatic is the improvement obtained by using a three component stabilizer system. This is illustrated diagrammatically in Figure 5 for a zinc/epoxy/phospite system⁸ which plots the color against time of holding at 150°C.

Action of PVC Stabilisers

(Heat ageing at 150°C)

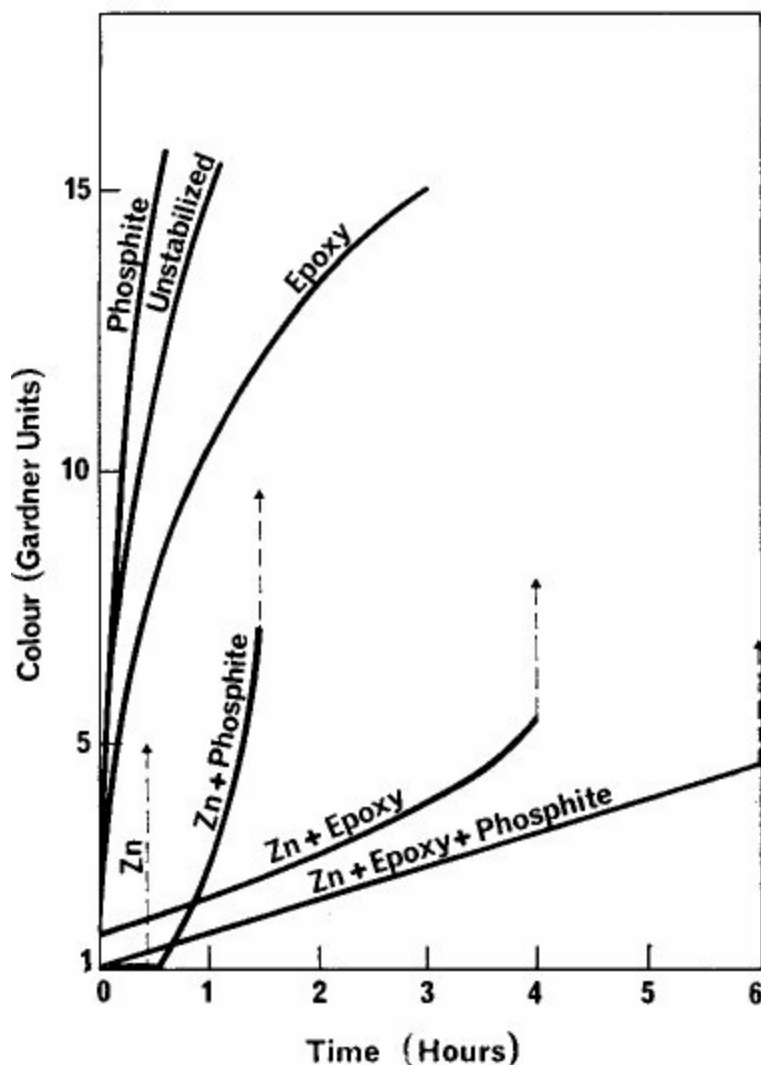

Figure 5. Effect of stabilizers on the discoloration of PVC during heat ageing at 150 °C. The stabilizers are zinc laurate, epoxidized soya oil and organophosphite.

Stress has already been laid on the fact that the theoretical basis of PVC stabilization is not yet fully established. Multicomponent additive systems have to be carefully balanced and tailored to particular grades of polymer. Yet this has not prevented great improvements in the technology in the last decade. Since thermal degradation involves both dehydrochlorination and free radical mechanisms, it is likely to have a number of similarities with radiation induced degradation where free radicals are also generated. Conjugated double bonding is shown by infrared measurements to be the major reason for discoloration in both cases. There are differences of degree, for example the color change on heating PVC is generally to pale yellow first extending to deep yellow and brown whereas radiation tends to produce a brown color straight away, pale to start and becoming darker at high doses. This indicates a difference in the length of the polyene sequences, probably around 15 units from radiation and only about half that from thermal treatment, but not in the type of effect. It is unlikely that oxidation plays a significant part in discoloration as the carbonyl group is not readily apparent. Conventional antioxidants do not appear to have much influence.

Of course toxicological inertness is vital for all components of medical plastics which prevents the use here of some of the many effective stabilizers derived from heavy metals or organotin compounds.

Yet there is little doubt that developments in recent years in the so-called “non-toxic” stabilizers have given grades of PVC with much better radiation resistance. Only a small improvement is needed to produce materials which are completely unaffected by one sterilization dose of radiation and this is likely to come from the further adaptation of existing stabilizer technology.

Polypropylene is another example of a plastic which is near the borderline for withstanding one sterilization dose of radiation. Different types of stabilization additives are required for polypropylene as compared with PVC and it is normally important to include an antioxidant. Figure 6 shows the effect of increasing the concentration of a particular antioxidant, tris(2-methyl-4-hydroxy-5-tert butylphenyl)butane, on a number of properties of polypropylene. Arbitrary scales are used for each characteristic. In general raising the concentration improves the performance, that is it lessens the amount of change, in all the properties listed. The elimination of any reduction in the oven life and in the tensile strength by incorporating 0.5% antioxidant is the most obvious improvement. Important from the service aspect is the arresting of the decline in impact strength. This property is of considerable relevance for molded packages, especially items of complex shape where some locked in strain is almost unavoidable. The melt flow index, a standard method of quoting viscosity of the melt, is related to the average molecular weight. The rise in the index on irradiation indicates a fall in the average molecular weight but this change is lessened at the higher antioxidant concentration. It is probable that the improvement from increasing the stabilizer addition results from the inhibition of oxidative degradation.

Radiation of Polypropylene-Influence of Stabiliser Concentration

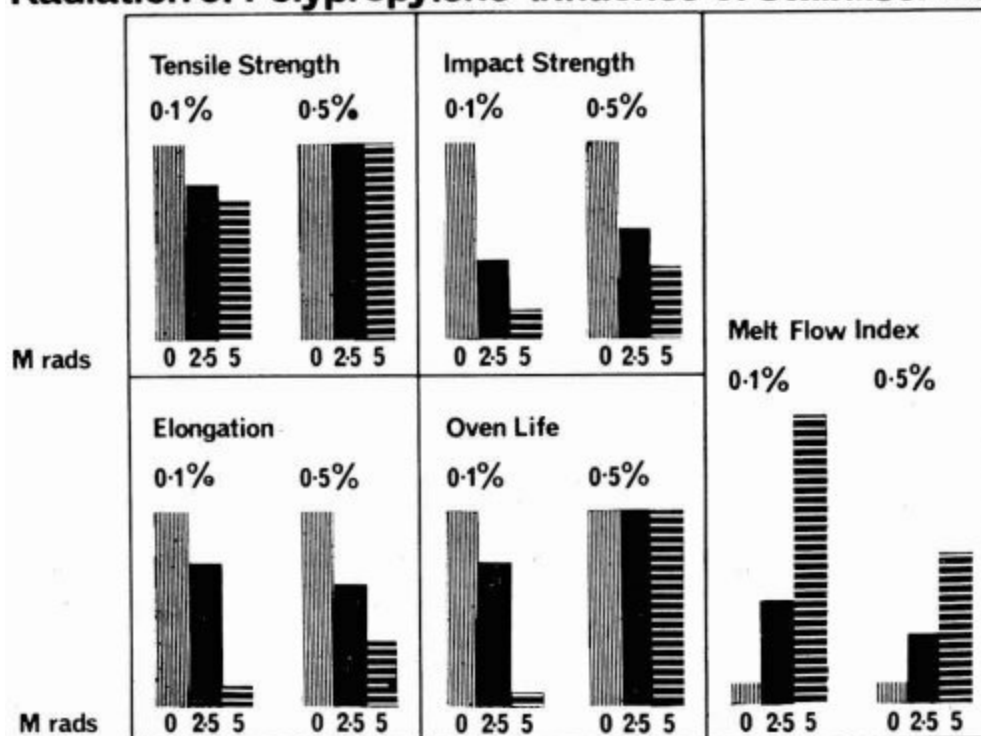

Figure 6. The influence of stabilizer concentration on the change in properties of polypropylene subjected to irradiation.

Conclusion

By far the most commonly used plastic material for packaging sterile goods is polyethylene. This has excellent radiation resistance and should show no deterioration resulting from radiation sterilization. A

number of other plastics are equally good. Some materials, particularly poly (vinyl chloride) and polypropylene, with valuable properties for specific applications possess only a borderline radiation resistance. Modern technology is already improving performance here and it is likely that further advances will come from modification to existing stabilizing additive systems. There are few packaging plastics which are unsuitable for radiation sterilization but these are of comparatively minor importance.

References

1. Plester, D. W. (1973) Effects of Radiation on Plastics in *Industrial Sterilization*, ed. Briggs Phillips, G. and Miller, W. S., Duke University Press, Durham, pp. 141-152.
2. Radiation Stability of Materials (1965). Radioisotopes Review Sheet G1. Wantage Research Laboratory. UKAEA.
3. Bolt, R. and Carrol, J. G. (1963). *Radiation Effects on Organic Materials*. Academic Press, New York.
4. Chapiro, A. (1962). *Radiation Chemistry of Polymeric Systems*. Interscience, London.
5. Charlesby, A. (1960). *Atomic Radiation and Polymers*. Pergammon, London.
6. Popovick, B. (1970). Effects of Gamma Radiation on Polymers. *SPE Journal* 26, 54.
7. Powell, D. B. (1973). Packaging of Sterile Medical Products. In *Industrial Sterilization*, ed. Briggs Phillips, G. and Miller, W. S. Duke University Press, Durham pp. 79-99.
8. Deanin, R. D., Foss, R. M., Gilbert, P. G., Guerard, R. F. and Muccio, E. A. (1969). Synergistic interaction in zinc/epoxy/phosphite stabilization of polyvinyl chloride. *Polymer Engineering and Science* 13, 2, 966-101.

Physical and Chemical Effects of Ionizing Irradiation on Cellulosic Material

W. C. BRADBURY

*Johnson & Johnson, DOC, Research Center, New Brunswick, New Jersey,
U.S.A. 08903*

Abstract: *In this presentation the effects of both gamma and electron radiation on the strength properties of some cellulosic materials are compared. Observations are presented indicating that electron irradiation does not reduce strength as much as gamma irradiation; this phenomenon appears to be a result of the much higher dose rates available from electron beam machines than from the gamma irradiator. In addition, some observations are presented showing that pre- and post-moisturization of cellulosic materials reduce the discoloration caused by irradiation. Although detailed mechanisms causing discoloration have not been elucidated, some evidence is presented suggesting that certain stable free radicals may be involved.*

Introduction

A survey of the literature shows that many studies have been reported on the physical-chemical effects of ionizing radiation on cellulose¹. Some of the parameters that have been considered are depolymerization reactions^{2, 3}, changes in strength properties⁴, the production of reducing groups and small molecular weight components including hydrogen and carbon dioxide⁵. These effects characterize the general degradation of the cellulose molecular structure which is considered to be initiated by free radical mechanisms. Studies by most investigators have been to clarify the nature of the radicals and were a part of research programs evaluating cellulose graft copolymers. These programs were supported by the textile industry in its research to improve cellulose fiber properties. Johnson & Johnson was interested in the interactions of ionizing radiation with cellulose for a different reason. Many of their medical products are either entirely cellulosic in nature or have cellulosic components. A large number of these products must be sterilized, and one of the sterilizing techniques used is ionizing radiation.

After sterilization, it is desirable to have little or no adverse change in the cellulosic physical-chemical properties. However, the radiation cannot discriminate between the unwanted bacteria and the cellulosic materials and as a result will cause ionizations in both. In the former case the ionizations lead to biological death whereas in the latter the ionizations can lead to physical-chemical changes. A series of studies were designed to measure some of the physical-chemical effects of ionizing radiation on cellulose. This paper will concentrate on observations made in two areas. The first is a comparison of the effects of the interaction of both electron and gamma irradiation on the tensile strength of some cellulose materials. The second area deals with the discoloration phenomenon of gamma irradiated gauze.

Tensile Strength Studies

Working, and distribution prohibited.

For gamma radiation exposures, an Atomic Energy of Canada, Ltd. (AECL) Gammacel 220 equipped for temperature control was used in our laboratories. Electron beam irradiations were made with four machines, these along with the Gammacel are listed in Table I. The ELT I and ELIT-1B accelerator experiments were performed at the Siberian Branch of the Academy of Sciences, Novosibirsk, USSR, through the courtesy of the Institute of Nuclear Physics. The Varian 10 MeV Linac experiments were performed for us at Risø, Denmark, by the Accelerator Department of the Danish Atomic Energy Commission. The FX25, high current Van deGraaff accelerator, built by High Voltage, Inc. was used in collaborative studies with Energy Sciences, Inc. of Burlington, Mass. The test objects were exposed to radiation doses ranging from one to fifteen megarads. The Gammacel was calibrated according to the Fricke Technique⁶, and thin foil calorimetry⁷ and blue cellophane⁸ were used to calculate the radiation doses of the electron irradiators. Three types of cellulose were evaluated: cotton gauze, a partially oxidized cellulose, and a needle-loomed nonwoven fabric. The tensile strength was determined by an Instron Tensile Testing Apparatus. Relative radical concentrations were measured with a Model E4, Varian Electron Spin Resonance (ESR) Spectrometer.

Table I. — List of Irradiators

Machine	Radiation Type	Energy (MeV)	Pulse Current (Amps)
ELT 1 (USSR)	Electron	0.7	0.015 - 0.020
ELIT 1B (USSR)	Electron	1 - 1.2	20 - 25
Varian Linac (Denmark)	Electron	10	0.0003
FX25 (USA)	Electron	2 - 2.5	2-20,000
Gammacel (USA)	Gamma	1.17, 1.33	—

Many of the physical-chemical effects observed corroborated findings reported in the literature. Very briefly, some examples of this are as follows. It has generally been observed that the strength properties of cellulosic materials decrease as the dose of radiation increases. Figure 1 shows this effect on cotton gauze. The decrease in strength of the gauze threads was a result of depolymerization reactions within the cellulose molecules. An increase in water extractables and carboxyl content, also reflected the occurrence of molecular cleavages, see Figures 2 and 3 respectively. Only gamma irradiation was used for these studies. The effects of gamma and electron irradiation on the tensile strength of cotton gauze were then compared (Figure 4). As expected, the greater the dose the greater was the loss in strength. However, unexpectedly, at the same dose levels the gamma irradiated samples appeared to lose more strength than the electron irradiated samples. This effect was greater in the partially oxidized cellulose (Figure 5). Paradoxically, however, a gain in the strength of the nonwoven fabric was observed (Figure 6). There seemed to be about a 30 percent, dose independent, increase in strength after being gamma irradiated. The electron irradiated nonwoven samples, showed less than a 10 percent increase in tensile strength. Although there was a difference between the effects on tensile strength after gamma and electron exposure, no difference was evident from exposure to the different electron irradiators.

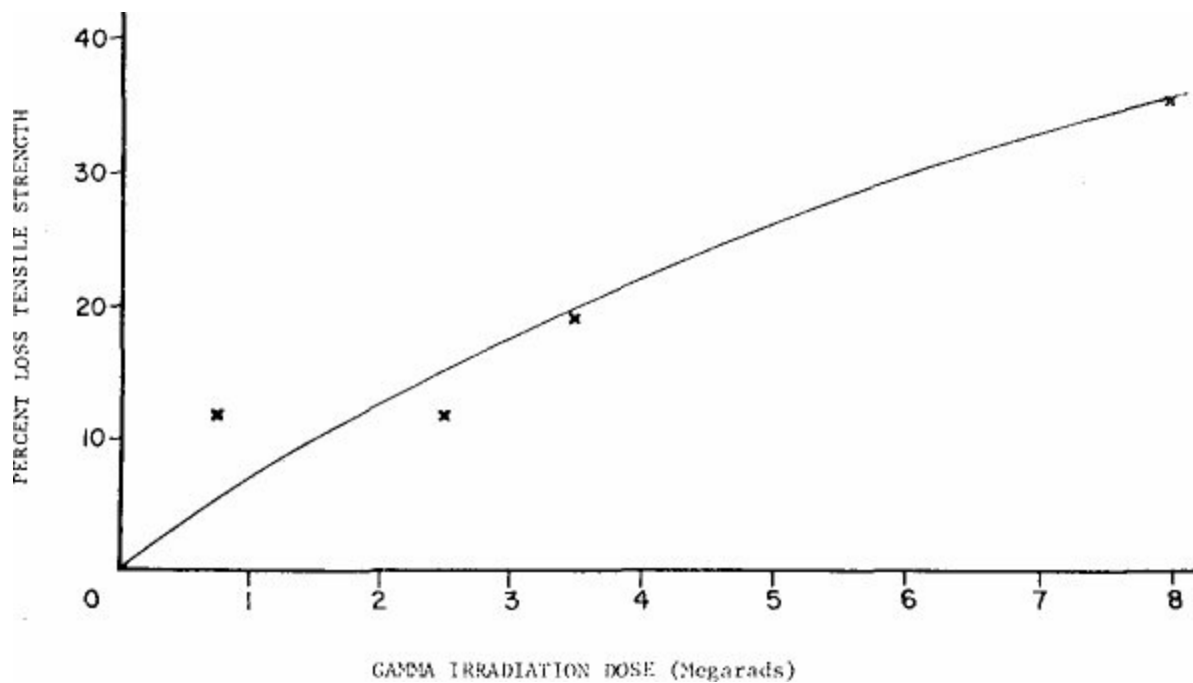

Figure 1. The tensile strength of cotton gauze decreases as the dose of gamma irradiation increases. All exposures were made at 25°C, for a time of 4.4 hrs.

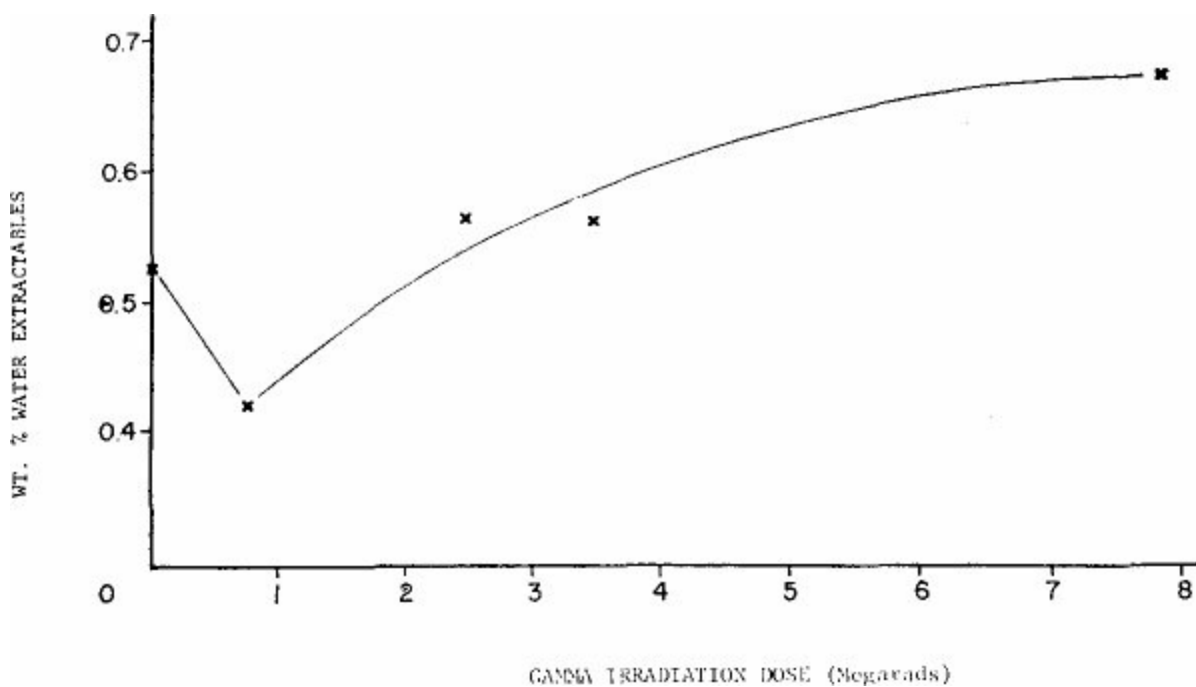

Figure 2. The effect of Gamma irradiation dose on the water extractables from cotton gauze after exposures at room temperature. Exposure time 4.4 hrs.

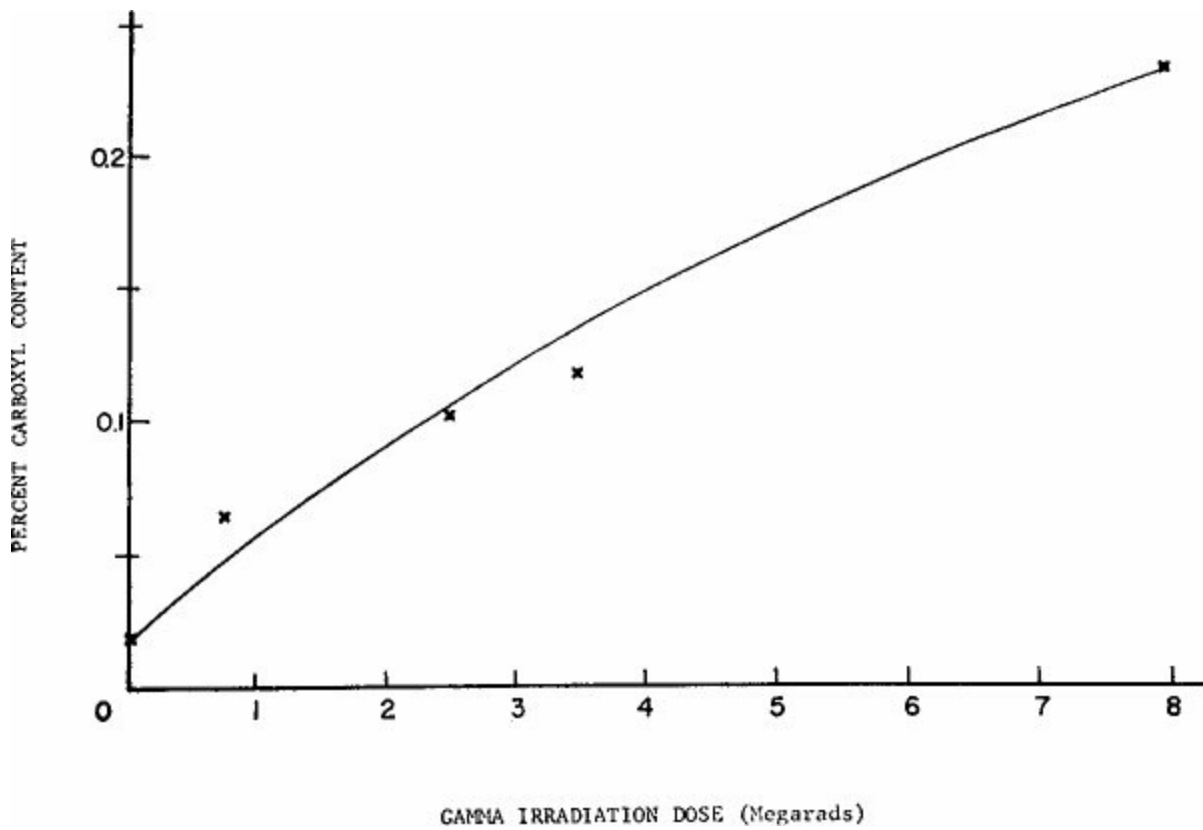

Figure 3. Increase of Carboxyl Content with increasing dose of irradiation of cotton gauze. Exposure time and temperature held constant at 4.4 hrs. and 25°C. respectively.

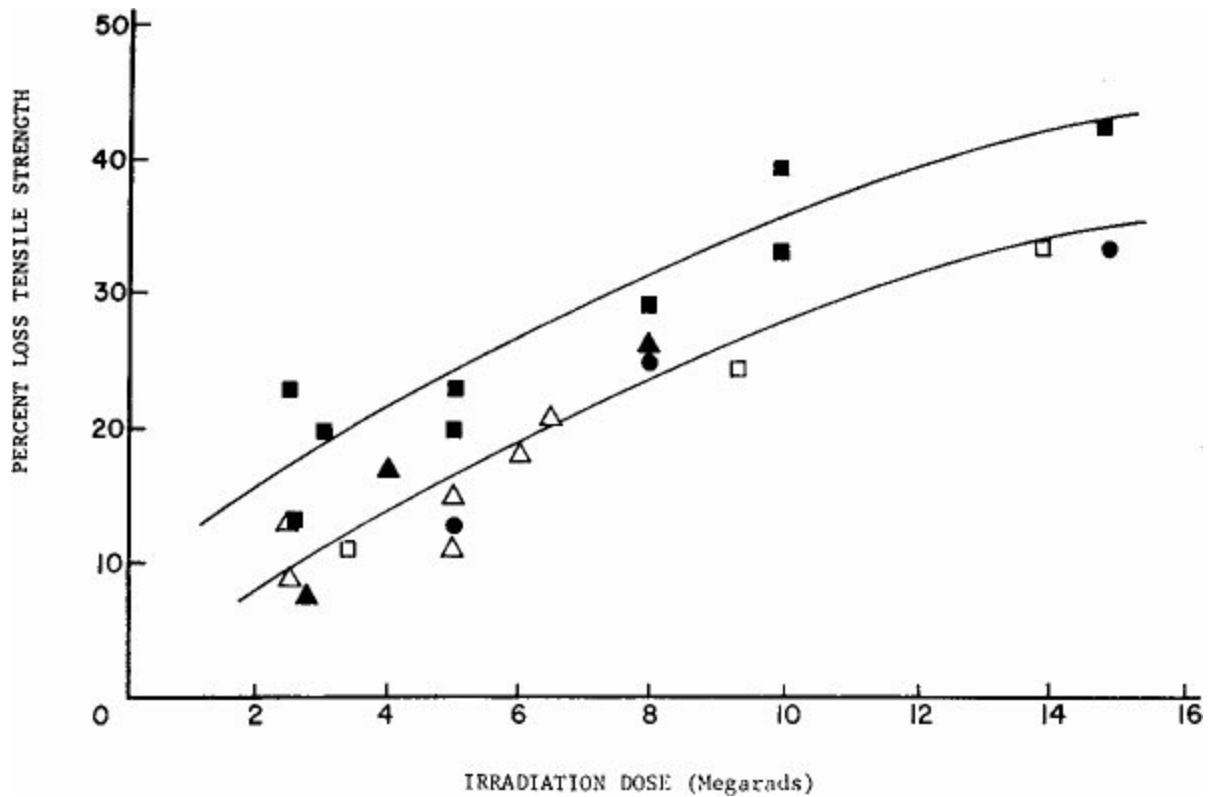

Figure 4. The effects of gamma and electron irradiation on the tensile strength of cotton gauze are compared. Gammacel (■), Varian Linac (▲), FX25 (□), ELIT 1B (△), ELT 1 (●).

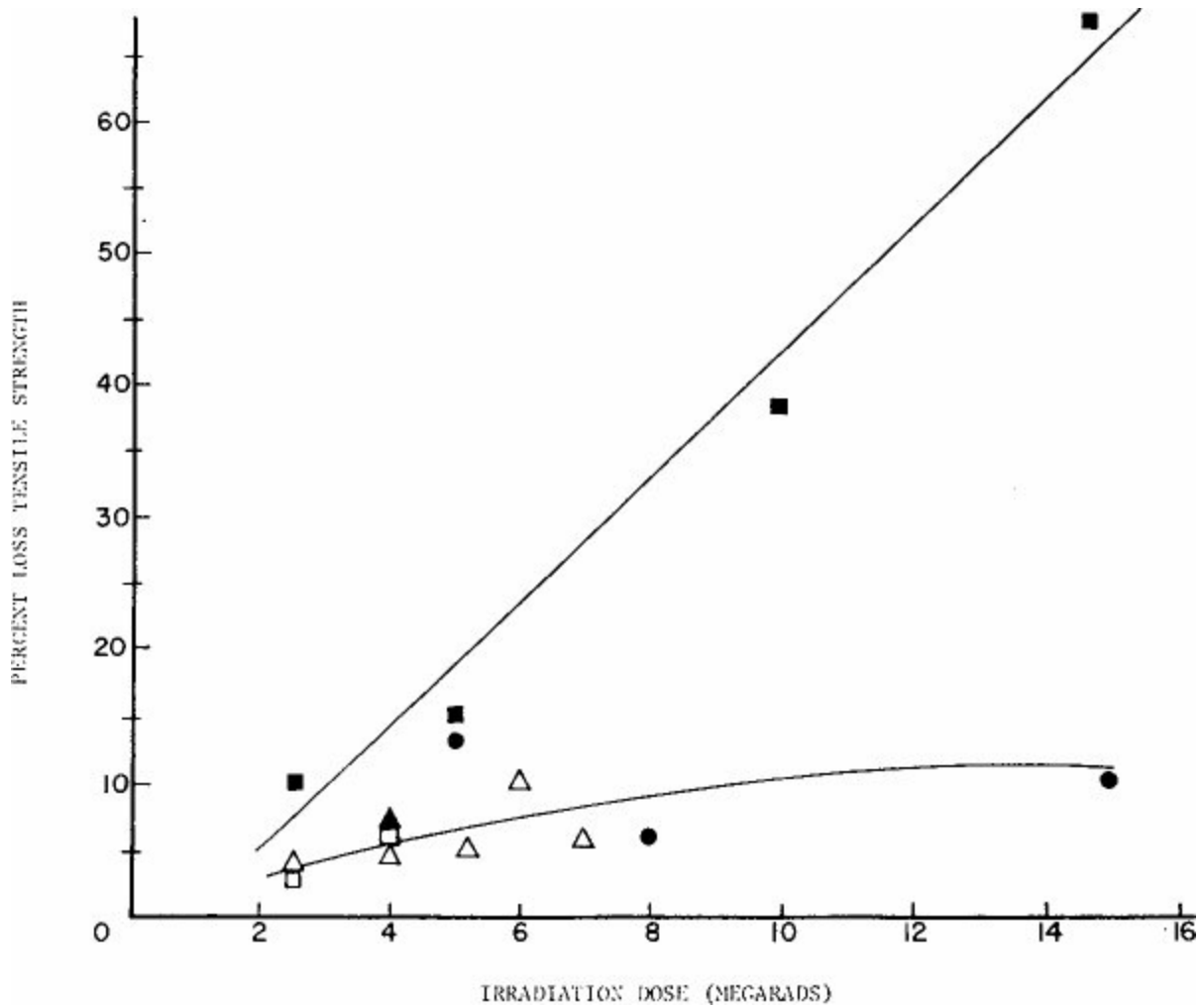

Figure 5. The effects of gamma and electron irradiation on the tensile strength of partially oxidized cellulose material are compared. Gammacel (■); Varian Linac (▲); FX25 (□); ELIT 1B (△); ELT 1 (●).

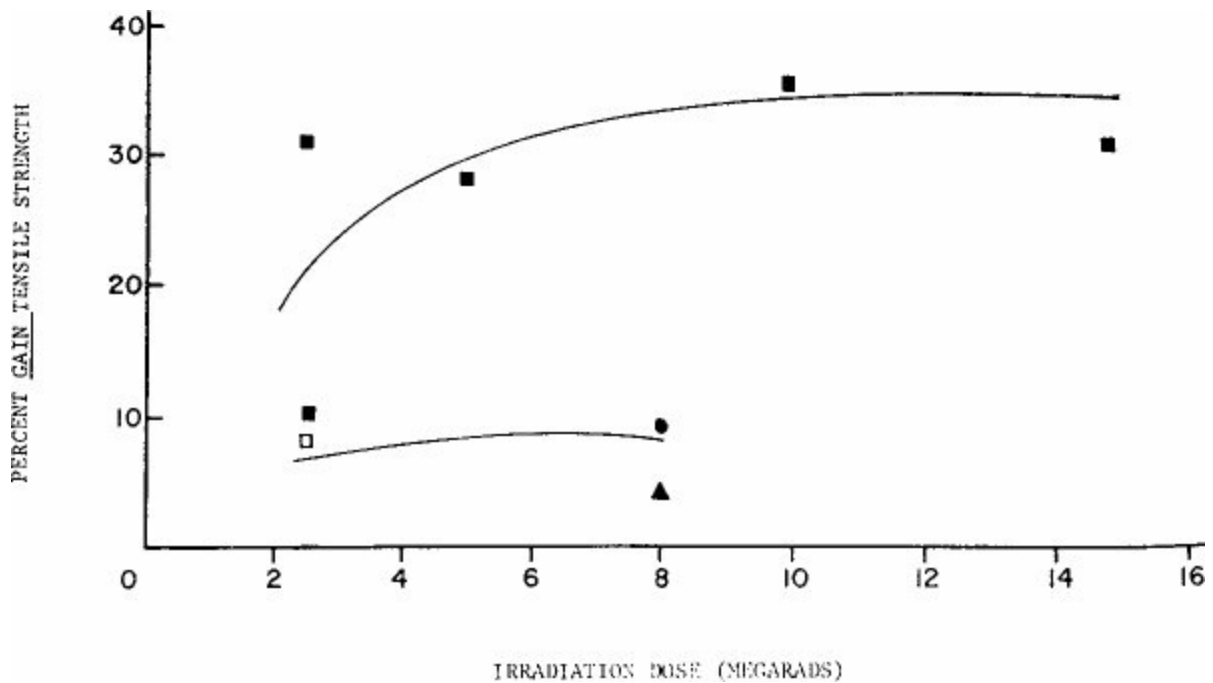

Figure 6. The effects of gamma and electron irradiation on the tensile strength of cellulose non-woven fabric are compared. Gammacel (■); Varian Linac (▲); FX25 (□); ELT 1 (●).

strength. The gamma photons from a cobalt-60 source interact with matter according to the Compton Effect. When the photons enter matter delta rays involving recoil electrons are generated. These recoil electrons and the scattered gamma rays proceed on to create more recoil electrons until the gamma ray is dissipated or leaves the matter. The electrons that are generated travel a relatively short distance in the matter before losing all their energy to interactions with molecules creating ionizations, excitation, and free radicals. When matter is irradiated by electrons, the nature of the mechanisms for the dissipation of electron energy is much the same as that of the gamma photons^{1, 9, 10}. In other words, whether delta electrons are generated by high energy electrons, or by photons, they interact in the same way with matter causing similar free radicals. It is generally held that the free radicals generated by the irradiation initiate the chemical reactions that take place to alter the physical-chemical properties. Concurrent with the physical testing on radiation exposed samples, the free radical concentration was measured on an electron spin resonance (ESR) spectrometer. As expected, the relative radical concentration increased proportionally with the dose of irradiation (Figure 7). It also appeared that the “long-lived” radical concentration at a dose level was the same for both types of radiation. “Long-lived” radicals were arbitrarily defined as those still detectable one day or longer after exposure. Not only the relative radical concentrations but the ESR spectra of radical species were identical (Figure 8). This suggests that the nature of the radiation, whether gamma or electron will induce similar “long-lived” radical formation at equal dose levels. Therefore, it is difficult to believe that the gamma photons and the electrons could be intrinsically responsible for the observed tensile strength differences, especially since it has been reported that chemical effect of the initial absorption of X-rays is very small¹. Another explanation was sought.

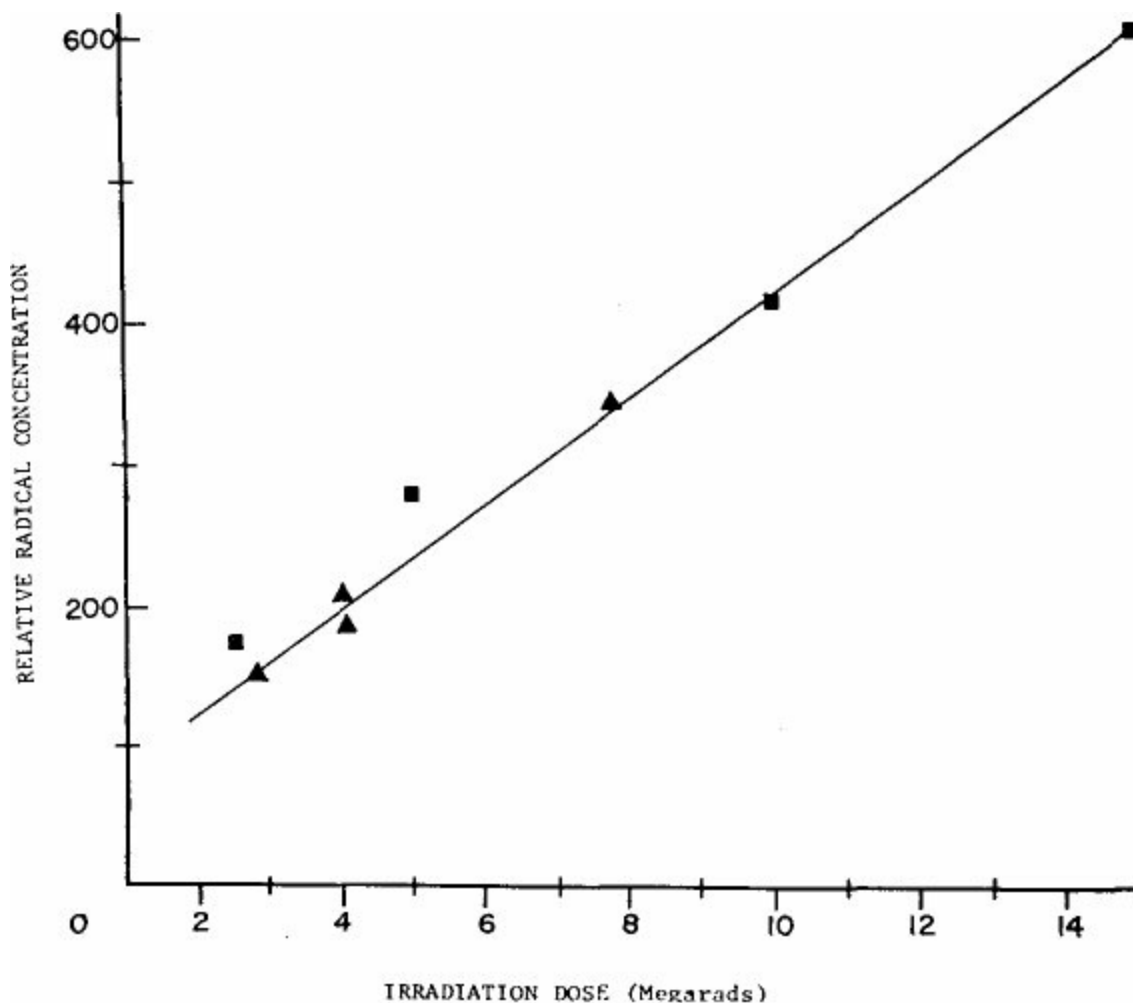

Figure 7. Both gamma and electron irradiation appeared to create the same number of trapped stable free radicals, regardless of the dose. The example above was measured 30 days post irradiation. Gammacel (■); Varian Linac (▲).

It has been shown many times that the free radical concentration is a function of absorbed dose. Although only “long-lived” radicals were measured in this paper, there were much higher concentrations of “short-lived” radicals that were not measured. These “short-lived” radicals can probably react in many different ways; but only three possibilities were considered: (1) depolymerization, (2) cross linking and (3) recombination reactions. The last type of reaction refers only to recombination of molecular cleavages. All of these reactions were probably occurring simultaneously. The influence of any one of these will depend not only on the parameter measured but also on the ratio of the frequency of occurrence of one of the reactions to the total number of reactions. With cellulose depolymerizations appear to have a higher frequency of occurrence and therefore have a predominant affect on changes in physical-chemical properties. In the case of cotton gauze and the partially oxidized cellulose material, tensile strength is a function of fiber molecular structure and as a result is especially sensitive to depolymerization. However, the needle-loomed non-woven fabric gets its strength from the entanglement of cellulose fibers. Irradiation causes depolymerizations which may alter the fiber properties thus enhancing the forces of entanglement, as shown in Figure 6. Cross-linking or recombination reactions, if they occur with higher frequency, might influence the effect that depolymerizations have on the fiber properties.

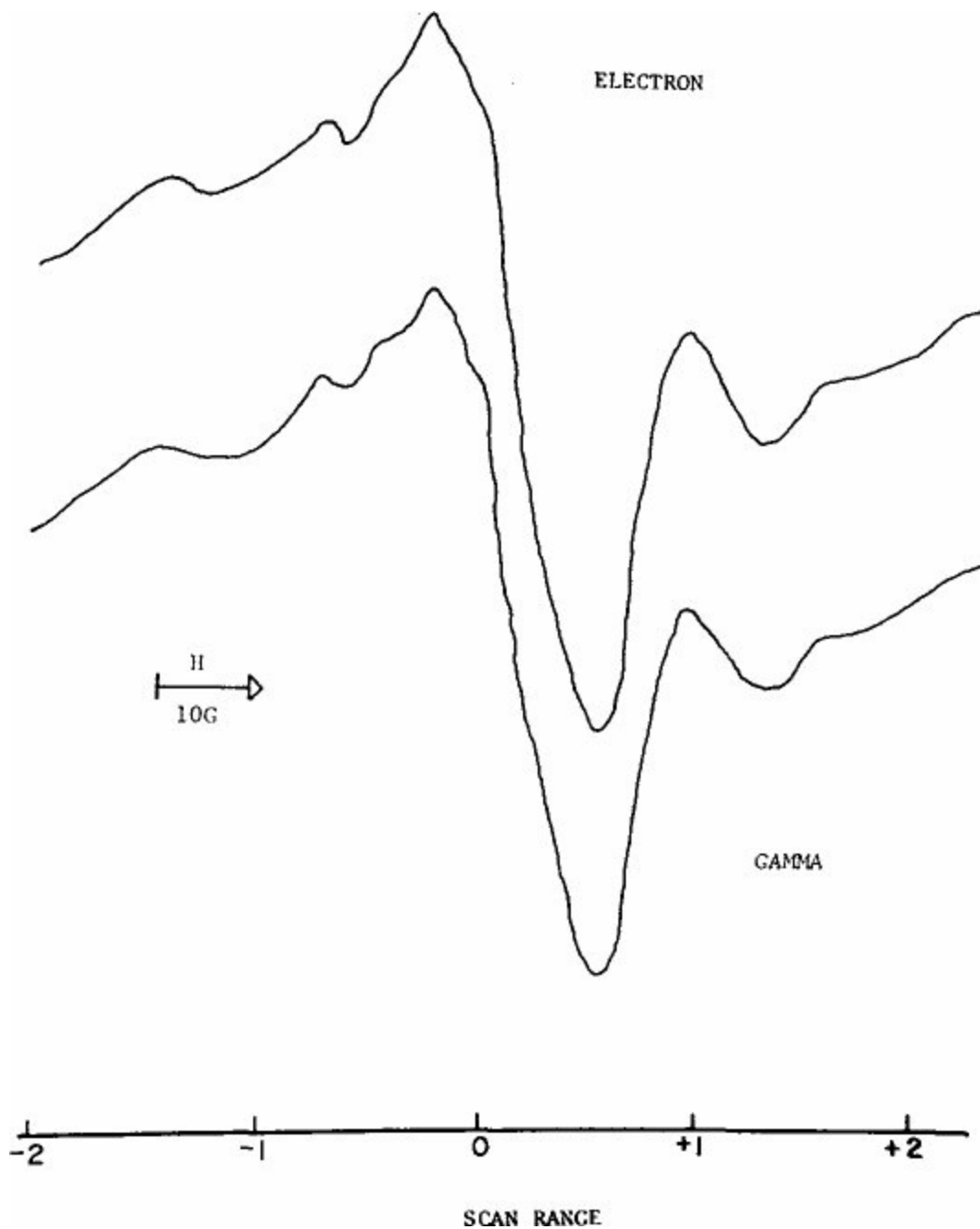

Figure 8. Comparison of the ESR spectra of "long lived" free radicals after electron irradiation (FX25) and gamma irradiation (Gammacel) of cotton gauze.

Along with this background, consider the following observations. Table II lists the irradiators with the approximate time required for each irradiator to achieve a dose of 1 megarad. As can be seen, the electron irradiators delivered a dose of one megarad at rates 10^5 - 10^{12} times faster than the gamma irradiator. For any instantaneous exposure, the absorbed dose and consequently the "short-lived" free radical concentrations (radical density) were considerably higher during electron irradiation. The higher radical density may have made it more likely for recombination or cross linking reactions to occur. Recombinations if they involve radical pairs that would normally lead to molecular cleavage, could have reduced the loss of tensile strength. If so, the number of depolymerizations would also be reduced. Recently, however, Imamura and coworkers³ have shown that from one to 100 megarads, the average degree of depolymerization increased with dose but was not affected by the type of irradiation whether gamma (1.6×10^5 rad/hr) or electron (7.9×10^{10} rad/hr.) From these data it did not appear that

recombinations of molecular cleavages could have significantly reduced the loss of tensile strength. However, radical-radical interactions might have occurred between neighboring cellulose molecules containing radicals resulting from dehydrogenation or dehydroxylation. It has been proposed by Fred Leavitt and others that these radicals lead to crosslinking or aggregation of adjacent molecules of cellulose^{11,12,13,14}. Since the density of radicals per unit time would be very much higher during electron irradiation than during gamma irradiation, there would be a greater chance for cross-linking-radical-reactions to occur during electron exposure. If these reactions were significantly numerous, reduction of tensile strength loss could be expected. This type of reaction could also explain the results observed with the non-woven cellulose fabric. The cross-linking might prevent the changes in mechanical properties that occurred within the gamma irradiated non-woven samples. Therefore, the electron irradiated samples would not show as large an increase in the strength of entanglement as the gamma irradiated samples.

Table II. — Comparison of Irradiator Dose Rates

Machine	Radiation	Dose Rate	
		Rads/sec	Sec/megarad
ELT 1	Electron	10^8	10^{-2}
ELIT 1B	Electron	8×10^{10} (Max)	1.2×10^{-5}
Varian	Electron	5×10^9	2×10^{-4}
FX25	Electron	$10^{13} - 10^{14}$	$10^{-7} - 10^{-8}$
Gammacel	Gamma	$10^2 - 10^3$	$10^3 - 10^4$

This cross-linking explanation could account for electrons and gamma photons having different effects on the strength properties of the cellulose samples. The dose-rate of the irradiators appeared to be more important than the type of radiation.

Discoloration Studies

Concurrent with the gamma irradiation studies, an evaluation was made of the effects of moisture on the interaction of gamma radiation with cellulose and the resultant effect on the tensile strength. It was found that the change in tensile strength appeared to be independent of the moisture content of the cellulosic material. However, the moisture content seemed to affect the extent of yellow-browning of the cellulosic material during irradiation. Studies were then designed to evaluate the discoloration effects.

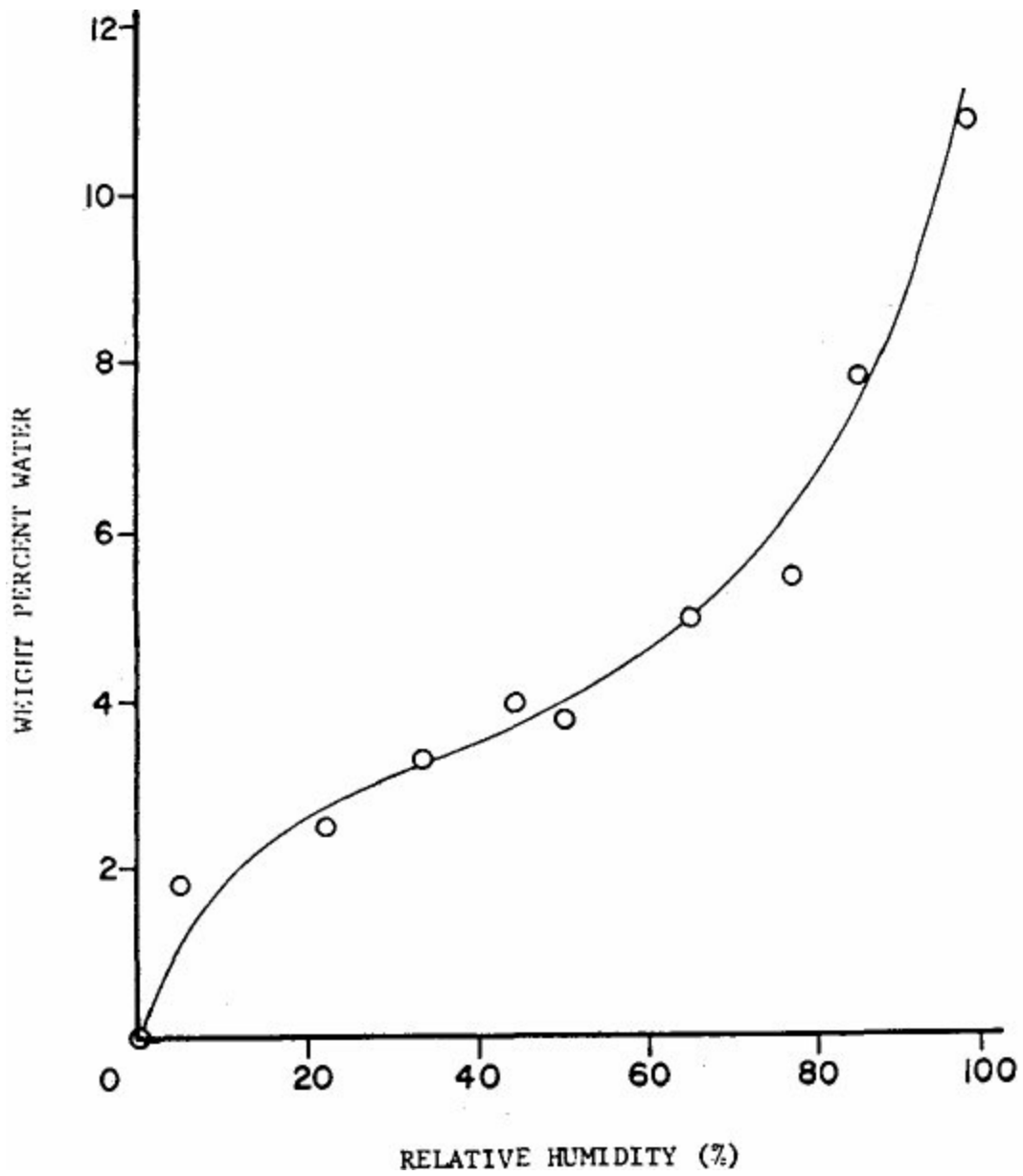

Figure 9. Absorption isotherm for cotton gauze. Pre-dried gauze was preconditioned for one week at relative humidities between 98% at 25°C. Weight difference determined using a Sartorius balance.

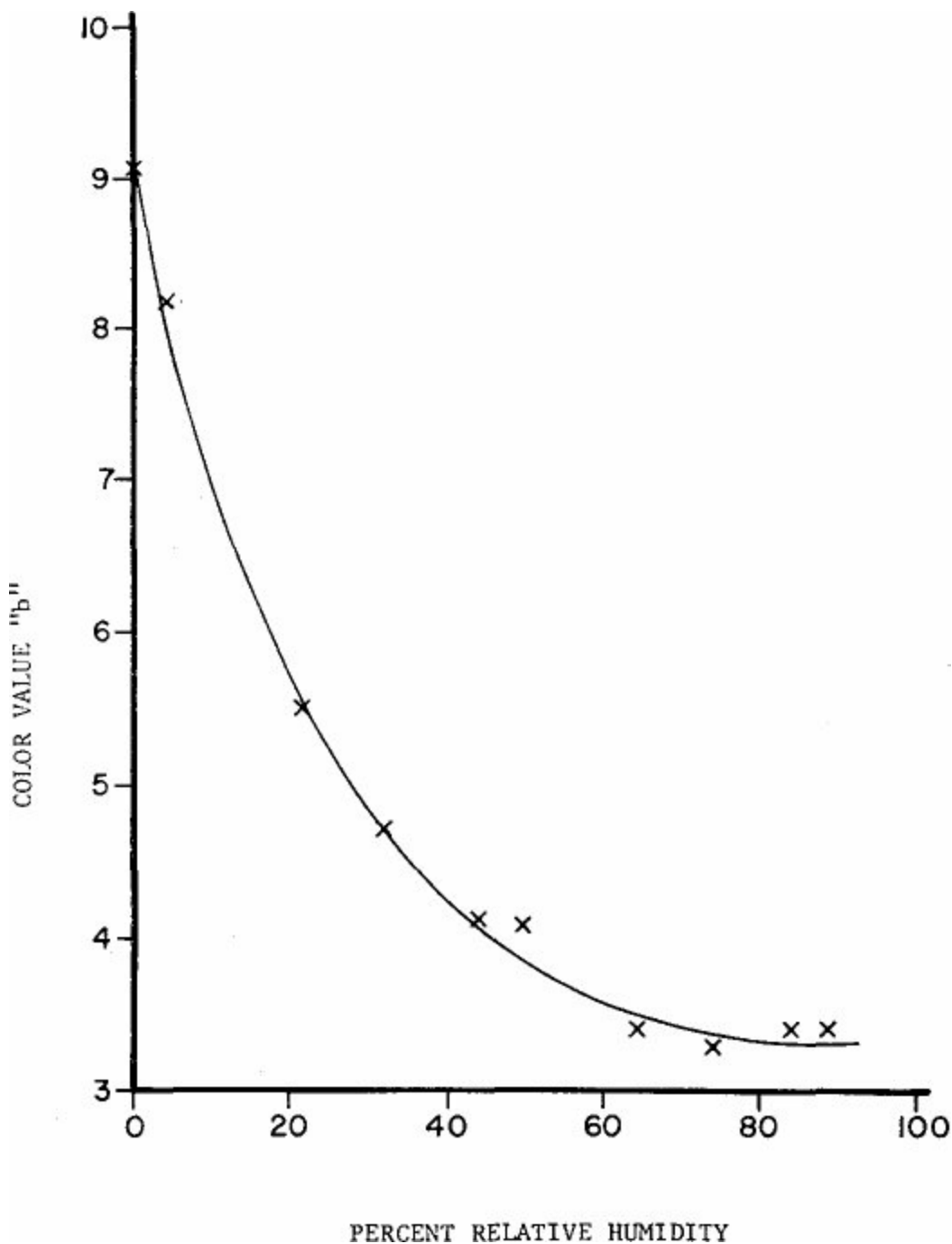

Figure 10. Degree of yellowing ("b") decreases during irradiation as the moisture content in cotton gauze increases. Samples preconditioned one week prior to exposure to 2.5 megarads at 25°C.

Although a number of materials were investigated, only the data on cotton gauze were considered. Samples of gauze were preconditioned for one week at humidities ranging from 0 to 98% RH at room temperature. Half the samples were used to determine the absorption isotherm and the other half were irradiated with 2.5 megarads. Shortly thereafter the color determinations were made using a Model XL10 Gardner Color Difference Meter. Figure 9 shows the characteristic absorption isotherm which was measured as the weight percent of water against the relative humidity measured at 25°C. The effects of premoisturization on the resultant discoloration during exposure to the gamma rays is shown in Figure 10. The color measure ("b") is a notation for the degree of yellowing of the material. As can be seen, the presence of moisture reduced the yellowing of the gauze. At higher than six percent moisture, it was difficult to distinguish visually any difference from the unexposed control. Redrying some of the samples after irradiation did not cause a return of the discoloration. Figure 11 shows that the degree of

color change paralleled the relative radical concentration. This suggests that the radicals may play a role in causing the discoloration, and that moisture may interact with the color related radicals to reduce the discoloration.

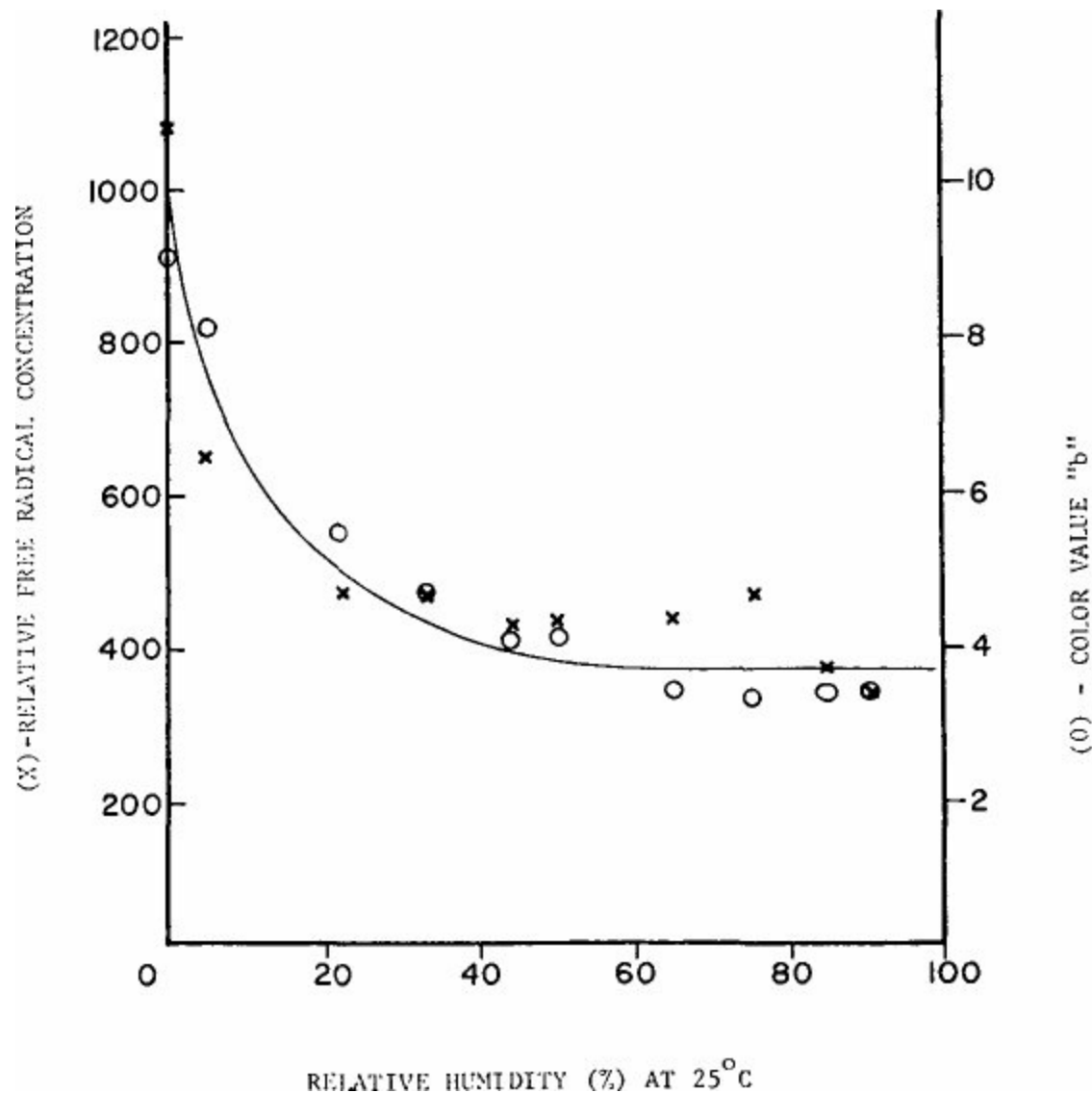

Figure 11. The decrease in free radicals parallels the decrease in the yellowing ("b") of irradiated gauze preconditioned at varying humidities prior to exposure to 2.5 megarads in the Gammacel. Relative Free Radical Concentration — (X); Color value "b" (O).

Since adding moisture to cellulose materials before irradiation caused less discoloration, another study was set up to determine if addition of moisture after irradiation could cause a reversal of the yellowing. Samples of cotton gauze were desiccated for seven days over CaSO_4 and then sealed in plastic bags immediately after removal from the dessicator to maintain a constant environment during irradiation. As before, the exposure dose was 2.5 megarads. After exposure the samples were removed from plastic bags and placed at varying humidities and stored for one week prior to the determination of color and free radical concentration. These data are summarized in Table III. In addition several samples were run through the drying-irradiation-humidifying cycle several times. After each irradiation samples were discolored to the same degree and after each post-humidification they returned, visually, to their original white color. It can be seen that in the post-humidification studies the relative radical concentration again paralleled the change in the color value.

RH (70°F)*	Relative Radical Conc.	"b" Color Value
0%	851	8.9
33	226	5.9
50	254	5.7
65	235	5.8
85	231	5.4
Untreated Control	—	3.8
0% Initial	747	9.8

* Stored for one week

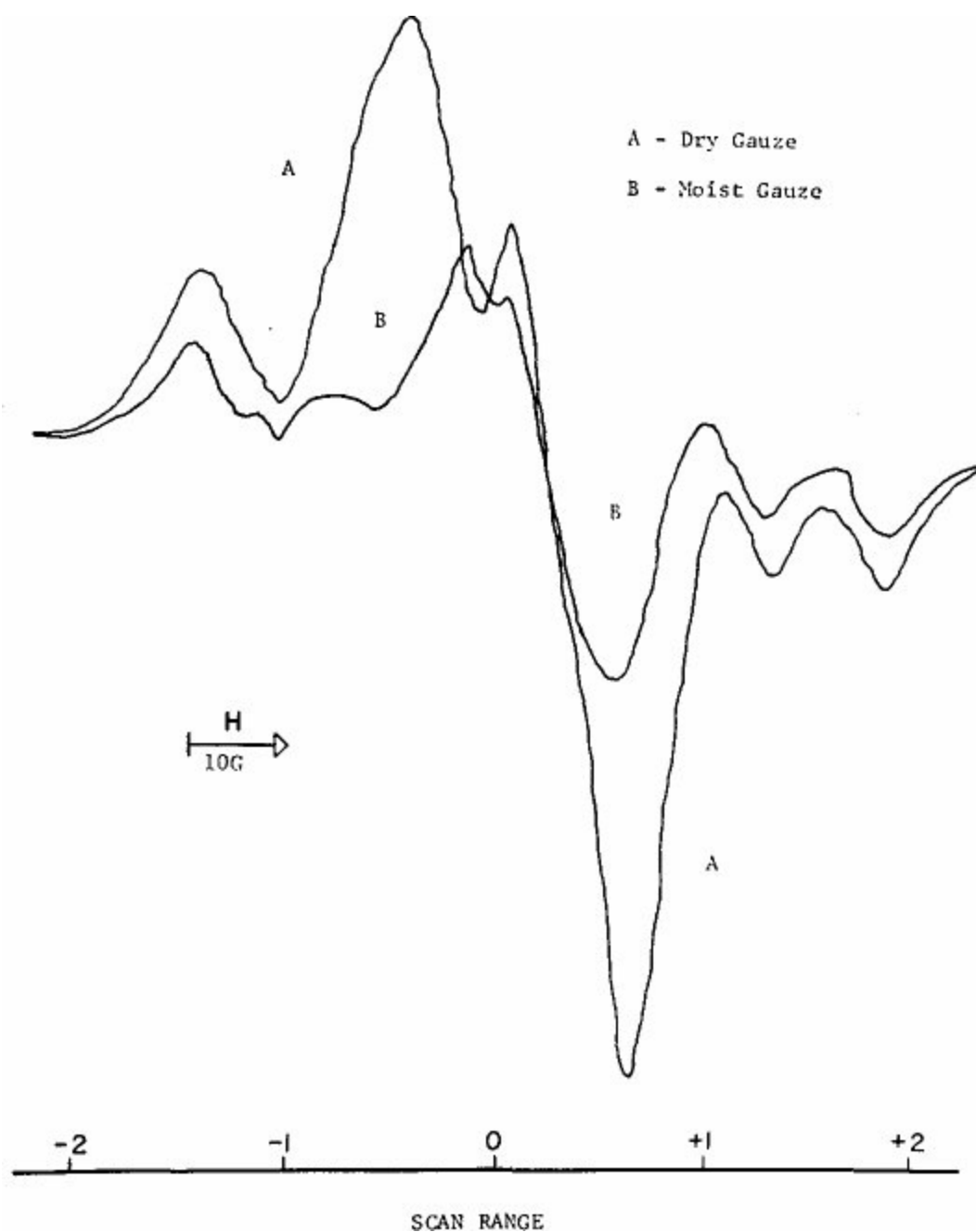

Figure 12. Comparison of the ESR spectra for gamma irradiated dry gauze (A) and moist gauze (B) which had been preconditioned at 0% and 98% RH respectively for one week prior to exposure.

Attempts were made to elucidate the radical-discoloration relationship, if one existed. But first the possibility that the discoloration might be caused by trapped free electrons was considered. The following observations were made. The ESR response remained stable at temperatures as high as 65°C.

The ESR band, characteristic of a free electron, could not be detected at the weakest microwave energy (0.02 mW) available with the ESR spectrometer. Radiation induced electrons certainly occur but cannot be stabilized in the cellulose structure at ambient conditions¹⁵. Since these observations did not support the presence of trapped free electrons, no further consideration was given to this possibility.

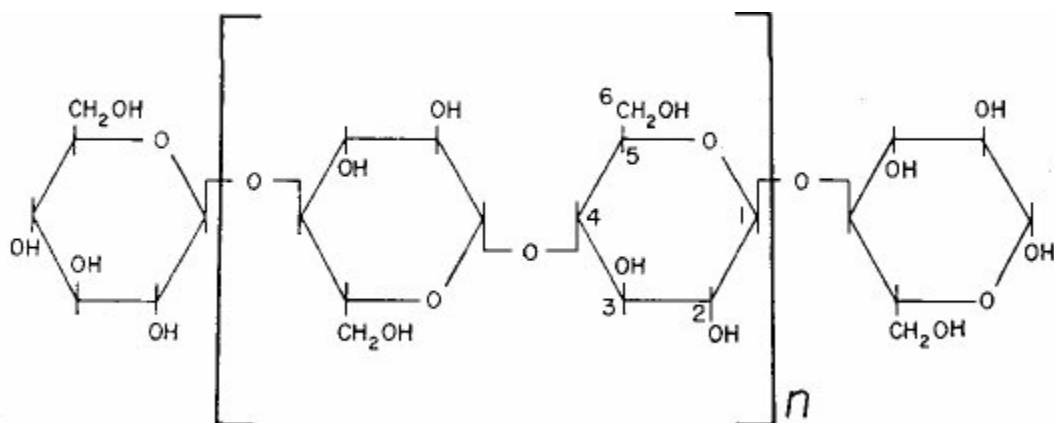

Figure 13. Schematic representation of a cellulose molecule.

According to ESR studies reported in the literature¹, the stable radical concentration is a composite of a number of different radical species. The ESR spectra reflect a high concentration of radicals when the gauze was irradiated in the dry state. As the gauze is allowed to regain moisture, the ESR spectra indicate that the number of radicals is reduced considerably. Figure 12 shows the spectra for both moist and dry gauze. That the remainder of the radicals are stable to the presence of water (see Figure 11) supports the observations of others that suggest that these radicals are located in the inaccessible crystalline regions¹⁶. From the literature analysis of the ESR spectra collected by Arthur and others it has been suggested that for dry irradiated gauze, localization of energy appears to be at carbons, 1, 4, 5 and 6 in the anhydroglucose unit of the cellobiose unit in the cellulose molecule, see Figure 13, leading to the “long-lived” radicals shown in Figure 14¹. As the gauze regains moisture, radicals of the Type IV and V disappear leaving radicals I, II and III. The water apparently interacts with the radicals at carbon 1 and carbon 4.

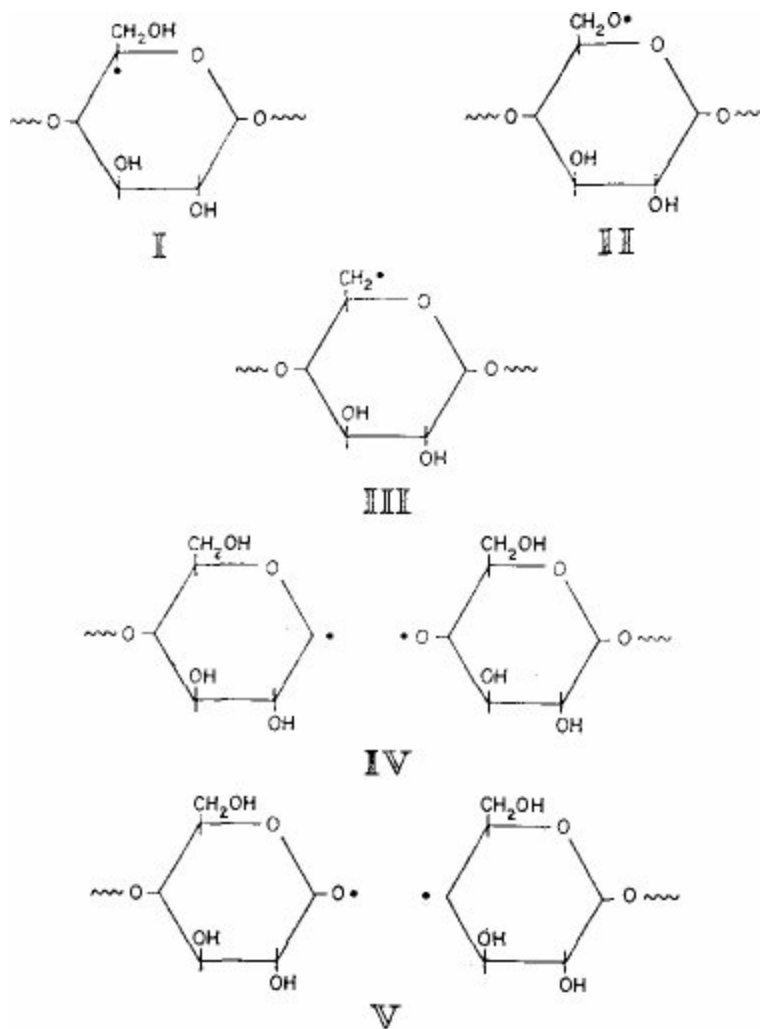

Figure 14. The most commonly referred to stable free radicals resulting from the irradiation of cellulose. From a summary on the subject by J. C. Arthur, Ref. 1.

The data already presented show that in the presence of moisture the loss of discoloration parallels the decrease in free radical response. In addition it has been reported that the radicals formed at carbons 1 and 4 disappear preferentially when irradiated dry gauze is moisturized. It suggests, then that the radicals formed due to the localization of energy at carbons 1 and 4 may be enough of a chromophore to cause the discoloration or yellowing of the gauze.

References

1. Arthur, Jr., J. C. (1971), Reactions induced by high-energy radiation. In *Cellulose and Cellulose Derivatives*, ed. Bikales, N. M. and Segal, L., Wiley-Interscience, New York, pp. 937-971.
2. Arthur, Jr., J. C., Blouin, F. A. and Demint, R. J. (1960) The Effects of Gamma Radiation on Cotton Cellulose. *American Dyestuff Reporter*. USA 49 (11): 21-26.
3. Imamura, R., Ueno, T. and Murakami, K. (1972) Depolymerization of Cellulose by Electron Beam Irradiation. *Bull. Inst. Chem. Res., Kyoto, Univ. Japan* 50 (1): 51-63.
4. Sandila, D. M. and Shamin, M. (1972) Effect of Gamma Rays Irradiation on Cotton Fibre and Yarn. *Pakistan J. Sci. Ind. Res.* 15 (1-2): 127-130.
5. Blouin, F. A. and Arthur Jr., J. C. (1960) Degradation of Cotton in an Oxygen Atmosphere by Gamma Radiation. *J. Chem. Eng. Data*. USA 5 (4): 470-475.
6. Sehested, K. (1970) The Fricke Dosimeter. In *Manual on Radiation Dosimetry*, ed., Holm, N. W. and Berry, R. J., Marcel Dekker, Inc., New York, pp. 313-317.
7. Radak, B. and Markovic, V. (1970). Calorimetry. In *Manual on Radiation Dosimetry*, ed., Holm, N. W. and Berry, R. J., Marcel Dekker, Inc., New York, pp. 45-81.

8. McLaughlin W. L. (1970) Films, Dyes, and Photographic Systems. In *Manual on Radiation Dosimetry*, ed., Holm, N. W. and Berry, R. J., Marcel Dekker, Inc., New York, pp. 129-177.
9. Iya, V. K. and Majali, A. B. (1972) Radiation Polymerization and its Applications. *Popular Plastics, Annual*: 79-86.
10. Byrne, G. A. (1969) Applications of High-Energy Radiation to Textile Materials. *Shirley Institute Bulletin USA* 42: 179-184.
11. Leavitt, F. C., (1961) Cross linking of Cellulosics by High Energy Radiation II, *J. of Polymer Science*, **51**, 349-57.
12. Bovey, F. A., (1958) *The Effects of Ionizing Radiation on Natural and Synthetic High Polymers*. Interscience, New York.
13. Chapiro, A. (1962), *High Polymers*, Vol. XV: *Radiation Chemistry of Polymeric Systems*, Interscience, New York.
14. Charlesby, A., (1960) *Atomic Radiation and Polymers*, Pergamon, London.
15. Dilli, S., Ernst, I. T. and Garnett, J. L. (1967) Radiation Induced Reactions with Cellulose. *Australian J. Chem.* 20 (5): 911-927.
16. Baugh, P. J., Kershaw, K. and Phillips, G. O. (1970) Radiation Chemistry of Carbohydrates, Part XVII. *J. Chem. Soc. (B)* 1482-1488.

Panel

Questions and Answers

To A. E. CHAPIRO — France, by: S. E. HUNT — England

Q. Dr. Chapiro has discussed the effects of radiation in general. Would he care to comment on the effect of the type of radiation on radiation damage in polymers? Would he, for example, expect similar damage for sterilization doses (2.5 Mrad) of electrons and gamma-rays on plastics containing chlorine?

A. Well, this is now a well established fact, that for the same amount of energy, you get the same amount of chemical change. So with respect to chlorine containing polymers, there is no difference between electrons and gamma-rays. There may arise a difference in dose distribution due to the fact that polymer chloride has a density of 1.5. If you irradiate a foil of say 3 millimeters with one energy level of electrons, you have a dose distribution in depth different than with less energetic electrons, and this may provide changes. However, if the dosimetry is inside the sample, in other words, the energy deposition in the sample counts, then there is no difference for chlorine compounds. Maybe I should add this one point to make things very clear. Chlorine compounds may show a slightly different apparent effect for low energy X-rays. X-rays below 200 keV will produce a larger fraction of photoelectric absorption, as was shown in one of the presentations yesterday or the day before yesterday. You have for heavy atoms, a larger contribution of the photoelectric effect with respect to combined effects. For a given X-ray beam, you may have a larger amount of energy deposited in the chlorinated compound than say polyethylene. But if you take into account this larger amount of energy deposited, there is no difference. For the same amount of energy deposited you produce the same chemical effect.

To D. W. PLESTER — England, by: S. ELLIS — England

Q. Can you tell us where it is possible to obtain PVC films that do not contain added stabilizer? This material should be useful for dosimetry property.

A. These are not available commercially. It is rather difficult to obtain such PVC without stabilizer without undergoing severe degradation. It may be possible to organize a special arrangement with

A. a manufacturer, should you happen to know one and get friendly with him. I don't know what the criteria would be for the thickness requirements of the film, or how special your requirements might be, or whether you would be prepared to accept some yellowing of the film when you got it. Now this is something which could be experimented with having a chosen manufacturer.

To D. W. PLESTER — England, by: R. FROHNSDORFF — England

Q. Does the desired data shown by Dr. Plester on the last slide for polypropylene refer to laminated or a molded product?

A. Molded product.

To A. CHAPIRO — France, by: W. L. McLAUGHLIN — USA

Q. From what irradiated polymer is there apt to be evolution of highly toxic gases such as HCN (acrylonitrile for example)?

HCN is only produced in minor traces by the irradiation of polyacrylonitrile, so one does not have to bother with the amount of HCN in the range we are concerned with (a few megarads).

A. I'm not sure of even whether or not large amounts of, I mean significant amounts of, HCN, do accumulate for very high doses. I'm not aware of any work in this field. Polyacrylonitrile is fairly safe with respect to irradiation response.

To A. CHAPIRO — France, by: W. L. McLAUGHLIN — USA

Q. What about the effects of radiation on the cross-linking or degradation of the so-called "safe" plastics, such as polyvinylpyrrolidone, polyvinylstearate and polyvinyl alcohol?

Polyvinyl pyrrolidone cross-links under irradiation as was shown by Dr. Charlesby in his slides showing solutions. The same is true for polyvinyl alcohol and polyvinyl stearate. However, if polyvinyl pyrrolidone and polyvinyl alcohol are taken as dry films, then they are in the glass state at room temperature, and behave very much like other glassy polymers, where the yield of cross-linking is extremely low. You can enormously increase this yield by either warming the polymer and irradiating close to the glass transition temperature, which would be fairly high for these two polymers, or by irradiating the polymer in the swollen state with 5-10% water which would be enough of a gel, a kind of gel of polyvinyl pyrrolidone or polyvinyl alcohol, where cross-linking can occur under irradiation. Perhaps I should add that all that is said is true for oxygen free irradiation. In oxygen you have these oxidative degradation effects which add up and I would like to comment on this in view of the last paper in which we have heard that at low dose rates you may have very severe oxidated degradations in the rubbery polymer or in the plasticized polymer, like PVP in water, and this may counter-balance the cross linking effect.

To A. CHAPIRO — France, by: T. B. FOX — England

Single user license provided by AAMI. Further copying, networking, and distribution prohibited.

I believe you stated there was little degradation of rubber below 5 megarads. Is it not true that

Q. there is a dose rate effect to be considered and that with low dose rates there could be significant degradation at 2.5 megarads?

In my paper, I tried to give a very general picture on irradiation effects on polymers and of course, I did not have time to distinguish between an individual polymer. I said that rubber and PVC were among the polymers used, which are most sensitive to those levels in the sterilization field. After a few megarads, 1 to 3 megarads, in the absence of oxygen, rubber shows increased cross-linking, increased vulcanization which is measurable. That means that rubber samples acquire a high elastic modulus, it becomes stiffer, even for these low doses.

A. Now, if oxygen is present, then definitely I agree with the the fact that rubber will suffer very severe oxidative degradation and this is particularly true for two reasons. One is rubber contains double bonds as a polyene and unsaturated polymers are particularly sensitive to oxidation. And second, rubber is rubber and it is an elastomer, where the mobility of the polymeric radical is large, and in one of the figures I showed you, I drew your attention to the fact that in the peroxidation process you get a radical. We add an oxygen molecule to produce a peroxy radical and this peroxy radical now abstracts the hydrogen to produce a peroxide leaving a second radical. This is a chain process. Now this chain peroxidation does not occur in glassy polymers because there is not enough mobility for the polymer radical to reach a neighbor and to significantly dehydrogenate. But in rubbery polymers or in any polymers above the glass temperature you have a chain peroxidation process and then of course, since you have a chain, the chain links will be very sensitive to dose rate effects. You have much more chain peroxidation with gamma rays than with an electron accelerator due to the same dose rate effect, which, in this particular case, is particularly important due to the chain reaction, a chain peroxidation process.

To D. W. PLESTER — England, by: K. MORGANSTERN — USA

Q. Is gas transmission through plastic film a problem for medical disposable packages and if so, what can be done to reduce such transmission?

A. May I, before answering this, while I've been listening, I have a few further thoughts about Dr. Ellis' question and it occurred to me that it might be possible to make PVC films without stabilizers by precipitating from a solution rather than pure PVC homopolymer, using one of the co-polymers for example, with vinylacetate, and if that sort of system was of any interest to you, I could talk to you about it afterwards. Going on to the particular question at this time, is gas transmission through plastic film a problem for medical disposable packages. I must admit that I had thought that gas transmission was a problem when you're using sterilization methods other than irradiation because you had to take steps to take epoxide or some other gas into the item under treatment. I'm not aware of this being a problem for irradiation. If it is a problem, the normal procedure is to use a laminate. Laminates for example, such as polyethylene or with nylon, can be considered since both products will withstand irradiation quite acceptably.

To W. BRADBURY — USA, by: I. DVORNIK — Yugoslavia

Q. What are the effects of gamma irradiation (2.5 megarads) in plant irradiation conditions? What about oxidation effects in plant conditions both on strength and useful properties (peroxides in contact with wounds)? Can cotton stand reesterilization?

If conditions are the same both experimentally, as for example, I have shown in my paper, as they are in the plant process, then the effects should be the same.

A. Oxidation does occur and in the case of a cobalt plant where it usually takes hours to achieve a 2.5 megarad exposure there is considerable time for oxygen to diffuse to the packaging or product materials. Strength is one of the properties that could be affected, but strength may not always be a property of concern with the useability of the product. If strength is a concern, the product development people realistically determine if the change in property will no longer permit useability. No comment on the peroxide question.

Extreme caution should be taken on reesterilization of natural cellulosic products. I have no data to share with you at this time. However, if useability can be maintained, I see no reason why it is not possible in these cases. I would recommend that each product developer do testing for useability to determine specifications for his own products.

COMMENT BY:

E. CHAPIRO — France

A. I would like to be a little more specific in the case of cellulose. Cellulose is a polymer like any other and it behaves like any other polymer, in other words, with respect to oxidation. Definitely, I'm quite convinced that there is a big difference in response to gamma-rays and electrons with respect to oxidation. But cellulose is a very complicated material with respect to its physical structure.

Cellulose contains crystalline regions which are hard to penetrate by irradiation, as well as by oxygen. Free radicals formed in crystalline regions persist as such as primary radicals for a long time even in an oxygen atmosphere. There is a slow diffusion, not of the oxygen into the crystals, but of the free radical inside to the surface of the crystal where it then reacts with oxygen.

Now the effect of water. Water has a double effect in cellulose. One is to plasticize the structure. Water does not penetrate into the crystallized structure but it loosens the structure around the crystallized area and therefore makes cellulose more reactive. The radicals are more readily accessible and, of course, they have a higher mobility. They can combine as was shown in the paper. But if water is present during irradiation, it has another effect, namely free radicals. Free radicals arising from irradiation of water are very efficient in abstracting hydrogen from the cellulose back-bone leading to a type of radical which is not a precursor to chain scission. It was shown several years ago that under proper conditions you could even cross-link cellulose derivatives in the presence of water.

To A. E. CHAPIRO — France or D. W. PLESTER — England, by: C. G. CRAWFORD — Sweden

Q. In the case of polypropylene, can you comment on the effects on irradiation stability, of heat treatment during, and subsequent to, molding extrusion?

A. D. W. PLESTER — I will say a few words then let Dr. Chapiro provide the real answer. Part of this question, I'm afraid I did not understand, i.e. whether the question relates to the effects of irradiation stability of heat treatment during or subsequent to molding extrusion. Heat treatment during molding extrusion is unavoidable. This is what the process is all about. Referring to the suggestion of heat treatment subsequent to molding extrusion and I assume before irradiation treatment, I think this might have some effects in certain cases because, particularly in the molding situation, when you have items of quite a complicated shape, which involves a fairly complex mold, there is often some locked in strain in the molding as produced and as used. I believe that part of the molding could be a situation which could subsequently be the brittle point in the item.

A. A. CHAPIRO — I would simply suggest that depending on the question whether the heat treatment refers to the irradiation stability before or after irradiation, you can answer the question this way. If you irradiate at a higher temperature, polypropylene degrades. If you heat polypropylene after irradiation, you will induce degradation by the trapped radicals or peroxides which are formed. Such treatment in many polymers may be beneficial, such as PVC, polyvinylpyrrolidone and so on. With polypropylene, it would be terrible. It would induce tremendous degradations.

To D. W. PLESTER — England, by: W. W. VINCENT — England

Q. Having examined many non-toxic stabilization systems for high molecular weight suspension polymers in plasticized PVC, I have concluded that the advantages in averting irradiation discoloration are marginal. Provided you are already using a good system, it appears that the choice of polymer, not to say polymer manufacturer, seems much more important. This I attribute to low level impurities within the polymerization process. Could you identify these and suggest how they might be removed at the source?

A. It is of course, true that PVC, as well as other plastics do contain low level impurities derived from their polymerization stage. Now, Dr. Vincent asked me to identify these and suggest how I might be able to remove them. Unfortunately, identification normally tends to indicate how the polymerization was carried out in some detail, which is possibly the manufacturer's secret know how. It is something with which I'm afraid I can not be of a great deal of help. But I can say that most polymers will contain a small amount of monomer from which they were made and reacted. They will tend to contain small amounts of certain active agent of some sort, which was used for suspending during the polymerization. The plastics industry does like to remove these traces as far as possible, because they interfere with the normal requirements of the plastic and you can assume, I think, that the plastic that you buy has been purified in this way, as far as is economically feasible.

Obviously, if you were to spend more money, they could be made purer. It will never be possible to remove these traces entirely and I don't know that I can go along entirely with the question of function that it is the residues which are the cause of good or bad performances in irradiation sterilization.

To D. W. PLESTER — England, by: S. V. NABLO — USA

Q. Your presentation provided a useful survey of polymer (film) properties for use in the radiation sterilization packaging field. Some of us concerned with aseptic filling and packaging are deeply interested in barrier properties as well. Could you comment on recent developments here vis-a-vis radiation tolerance, e.g. Saronex™, Barex-Lopac™, etc.

A. Barex-Lopac™ is a type of product which has recently become prominent because of the excellent barrier properties and the ability to make packages which contain carbonized liquids. Carbonated perhaps is a better word. Now, I know of no experimental information on the irradiation resistance of this class of material, but I think with apologies to materials of similar sorts, which have been around for some time, styrene, etc., I would be inclined to guess that it would be quite acceptable for a single sterilization dose.

To D. W. PLESTER — England, by: Anonymous

Q. You have stated that PTFE is not a suitable material for sterilization by ionizing radiation. On the other hand, investigators have reported successful irradiation of PTFE using 2.5 megarads in cobalt-60 without adverse physical effects. How do you explain these differences?

A. Well, that's putting me on a spot. I cannot explain these differences. I feel that we can only assume that one of the reports is wrong. The literature indicates the PTFE undergoes more than 50% reduction in internal strength at considerably below 2.5 megarads dose. Perhaps of course they started with the use of PTFE and it is not a requirement for internal strength and that sterilization can be satisfactorily achieved on PTFE. I think he can only mean that substantial reductions in PTFE physical properties are not important in this particular application.

General Discussion

Comment by

N. W. HOLM — Denmark

PTFE is one of the most interesting polymers because in theory, it should not be very different from most polymers and yet, it is very sensitive to irradiation. So much so, that I figured in certain places they have forbidden the use of PTFE anywhere near a reactor, which is nonsense, but it's not the only case of nonsense. But it seems to me that first of all there is the oxygen effect and secondly PTFE possibly has a different homology to other polymers and the strength in between the crystals relies on a very few bonds between crystalline regions and if the energy absorbed in the whole material migrates to these particular places, then the whole thing falls into a powder. You're not damaging it more, but you're damaging it at a vital place and the oxygen will of course, help a lot there. I think that more work on PTFE, as an irradiation material is very important, but oxygen is certainly one effect.

Comment by

J. C. KELSEY — England

I would just like to make one point on the last discussion on PTFE and high costs. It illustrates a danger in hospital use for irradiated products which may be unfamiliar to some people here who are not familiar with hospital practice. A cheap disposable item is treated as disposable. A complicated, rather more expensive item, if for some reason it is not used or perhaps unsterilized and it is wanted to be used again, the hospital may try to save money by having it resterilized by re-irradiating it. This can sometimes be done by putting it in unidentified with a miscellaneous load of materials saved for irradiation. Trouble has been caused in the past by this procedure. I think, it is important that in hospital use re-sterilization should be regarded as a very doubtful procedure only to be carried out when expert advice has been received.

To W. C. BRADBURY — USA, by: K. MORGANSTERN — USA

Q. Do you know what the degradative changes are on the same material you were showing on your slide when subjected to heat sterilization in contrast to the change that took place under irradiation?

The changes with heat sterilization, I'm thinking of steam, moist heat, in the first instance with the cotton gauze, are fairly minimal. The changes with the partially oxidized material, we would not

subject to that stress and I would not venture to guess that we have any information. I would expect
A. no problems and no changes really with the non-woven materials either. In dry heat, now you're getting to higher temperatures where you're going to see larger degrees of degradative oxidation due to the thermal effects. Discoloration effects will be present. I would say, you want to avoid dry heat sterilizing of this material.

Comment by

D. SCHULTE-FROHLINDE — West Germany

I would like to make a small comment concerning this remarkable effect of using different kinds of irradiating electrons on the one side and gamma rays on the other side, on cellulose. I think that there could easily be an effect of dose rate because we found in our investigation on sugar solutions, that there are molecular reactions taking place in the sugar radical transformation. This reaction includes re-opening reactions, elimination of water, elimination of carbon monoxide and so on, and these are reactions which are relatively slow. If you irradiate at a high dose rate, then the radicals that are produced in cellulose may react together before this transformation reaction, etc. could have had time to occur. On the other side with gamma radiation there is plenty of time and this transforming reaction could take place and a different kind of product could be formed. This is one possible explanation. Another possibility is taking into account the oxygen effect. With the presence of oxygen, we found that completely different reactions occurred and also that oxygen reacted. It could be that irradiation at high dose rate with electrons, the oxygen is consumed. Other reactions take place in the presence of oxygen with low dose rate irradiation processes such as gamma rays. This is only a suggestion; I have not experienced it with cellulose itself.

Comments by Moderator:

K. L. OSTROWSKI — Poland

Please excuse me for a few personal remarks since the conference is coming to an end and the remarks I want to make are shared by many people that I have been in discussion with. There is no doubt it is a very good conference, extremely well organized and on a very high level. There is also the opinion that it is a little bit unbalanced in that those persons who are microbiologists or just biologists have learned a lot by hearing all of the discussions and lectures given, but I would look forward really to another conference like this, where it would be just the reverse. Where we could really tell about the hard life and complexities that are involved in biology itself to the education of the engineers and physicists. You, probably as we, all enjoyed the extremely competent and good lecture by Dr. Chapiro. You remember also the end results that the Doctor was telling about — all those things that might happen by interaction of irradiation energy with polymers. It is not really so bad, because in the range of 2.5 megarads, which we are using for sterilization, I think they do not happen at all. And this is probably true when you discuss sterilization in industry. When I am putting bone, into the gamma cell or into the accelerator to get 2.5 megarads into it, I know that it's not the chemical attack of interaction as such that is damaging the bone. I know I'm damaging not only chemical properties but lots of biological ones. That's something that I believe should be discussed and I hope it will be balanced in a future conference, which probably will be organized.

Comment by:

I. SIZER — USA

I think I should rise to the defense of our moderator, who commented very briefly about the biological effects on bone. There might be a little more to the story than just the physical chemistry that we have been talking about today. The conference is after all, a conference on sterilization, which in your definition, relates to the destruction of microorganisms and it reminds me very much of a doctoral thesis candidate who was given a dead bird to look at. He had his MD and he looked at it and looked at it, and after a while, he said, "Well, Professor, the only problem I can think to raise at this point is to investigate the cause of death." And the cause of death has not been thoroughly explored in these last few days. I maintain that although this would be the subject of another conference, it is still pertinent to what we are talking about at the moment. For example, how much can we learn from biopolymers by discussing the physical properties of high polymers that we have been talking about? I would submit that we can learn just as much from the point of view of physical chemistry, by going from the reverse phenomena and study all the properties of proteins, their biological properties, the properties of nucleic acid and extracting from them the possible implications, with reference to physical chemistry. Let me give you an example. The irradiation sterilization of the enzyme ribonuclease results in the disruption of four disulfide bonds resulting in sterilization of this particular biological molecule. But on the other hand, along can come an enzyme called, if you like, re-arrangase, which can act upon this denatured molecule and resynthesize this disulfide bond and reconvert this inert sterilized molecule into an active one. By the same token, in the irradiation of a bacterial cell, the DNA molecule can be similarly disrupted by a mechanism that Dr. Chapiro pointed out this morning, but at the same time, there is an enzyme in the bacterial cell that can put this molecule back together again. It is the same situation when we think about biological molecules, in particular collagens and their crystalline structures and what irradiation sterilization can do to them. Let me remind you that in this whole area of sterilization, it was early work by Van Winkle and Chandler using the collagen molecule which gave us great insight in what could happen in biological systems in the field of sterilization, how it could be controlled and how could we understand the effects on various species of bacteria, molds, ... etc. So my final message is, we must include in our discussion of high polymers, the biological polymers as well.

Comment by:

L. SZTANYIK — I.A.E.A. — Austria

May I give some sort of an explanation of this one sided character of the present conference. At the time of the organization of this conference, Johnson & Johnson was already aware of the fact that the International Atomic Energy Agency is organizing a symposium on irradiation sterilization. This will be the second International Symposium on the Irradiation of Medical and Biological Products. If they wanted to avoid any kind of overlap of the program of these scientific meetings, we agreed that all micro-biological aspects, all the effects of irradiation on bio-polymers, all the problems concerning the legislation and regulatory aspects will be covered by the Agency meeting and that the technological aspects and development are covered by this conference. The conference of the Agency is supposed to be held in Bombay in December of this year.

Comment by:

A. CHARLESBY — England

I thought there is one piece of information which might not again come up and which might be of interest. I don't know if anyone has become interested in morphology, and if I can use it, since, perhaps, everything else has been covered. But we have done a fair amount of work years ago on the irradiation of certain water soluble polymers and the effects of irradiation were very surprising. They may be relevant to other people, so perhaps, if you'll excuse me, I'll recite them very briefly. I just want to give you a bit of information which has come out of a puzzle worked on some years ago which may be relevant. One aspect which has not been discussed is concentration. Now this undoubtedly will also occur in biological systems. The idea is that if you irradiate a simple water soluble polymer, things like polyvinyl alcohol or polyvinyl pyrrolidone, at a certain dose, it will become a gel. It becomes a swollen solid. You just irradiate and when you turn it upside down it does not flow. That is the answer. It's a very simple experiment. If you adjust the process for producing radicals which give cross-linking, the point at which you go from a soluble to an insoluble material corresponds to one link per molecule. It's a very precise quantitative measure of the effect of irradiation on the molecule. If you do this with a water soluble molecule you get a rather curious curve. Here is your concentration of the water soluble molecule and here is the dose needed to turn it from a soluble to an insoluble material, which is a very good measure of the irradiation effect. The curious thing is you'd expect the more concentrated your polymer, the more effective your irradiation will be. It's exactly the opposite. The dose you need to form this one link per molecule is high at high concentrations, as the concentration goes down the molecules are further apart and it becomes easier to link them. So it goes down like this, until you reach a concentration of about 1% and then the dose required suddenly goes up like this. Now, that looks already like a very complicated system. I hope it's of some interest to somebody else, but anyway, the point is to try to explain this rather curious curve. Why does it go down? Why is it easier to link them together when they become more dilute? The answer is that you're not only irradiating the polymer, which is polyvinyl pyrrolidone or polyvinyl alcohol, but you are also irradiating the water. It's the water which you irradiate which then affects the polymer, producing radicals in the polymer, which then gives you this reaction. Now the amount of material irradiated is the same, but the energy going via H's and OH's eventually ends up on these materials. The fewer there are of these, the greater chance of any one being attacked. It's rather like if you've got a certain inheritance, the fewer people who survive, the more each person will get. So that explains this part of the curve. So why does it suddenly become almost impossible to form a network below the 1%. Now the answer again is roughly like this. To give you effectiveness, you got to separate molecules and your irradiation via these things gives you a cross-link here and if you carry on this process you'll get your network. But if your molecules are very dilute and no longer like this, there is one here and one here and one over here, there's still available radicals for them to link, but the chance of that radical meeting a radical over here is very small. It's much more likely to find another radical on the same molecule. I'd say you get not cross-linking but you get linking inside molecules and internal links. The more concentrated a polymer, the greater the chance of this one meeting another one, the more dilute the more chance there is of it not finding another one, therefore linking internally. So in this linking, you get a network, that's one to another to a third and here you will get what we call a microgel, very small molecules. You'll link internally each molecule and the more you irradiate the smaller it gets. So I think you have a very astonishing effect of

concentration on these molecules and there will certainly occur in water soluble biological molecules a very strong concentration dependence. Now these molecules are obviously utterly different from these. These are microgels, these are molecular gels and of course, if you put in an additive and so on, for irradiation protection, you can prevent this happening until you get to a much higher dose. You can measure irradiation protection if you want it that way. Another simple way — you just find out how much longer you have to wait before it turns solid, when you turn it upside down. It's the kind of experiment I like ... I just distinguish between the solid and the liquid. After that I think it's an excuse. So the point is this, that here you have an effect. It's an effect of concentration of polymer. Now presume you buy a polymer which is very very sharply dependent on this 1% dose. That 1% obviously depends on the molecular weight. In bigger molecules, the figure will certainly become probably higher. So, I'm just warning you if you're doing any of these simple experiments with biological molecules in aqueous solutions, you have to be looking out very very carefully for concentration dependence and it's a very curious dependence, which you can explain. If you decide to explain, you probably can, as to why it's purely a matter of orientation and an electrical water structure within the solution, and it will depend on a number of things, particularly on the pH. It will depend on the molecular weight and depend on the actual shape of the molecule in solution. In fact, it seems to me rather a good method of measuring shapes of molecules in solution. I don't know if it has any relevance at all.

Comment by:

K. CHADWICK — The Netherlands

I'd like to ask Dr. Charlesby two or three things — first where is this published ... ah ah ... that's a relief.

Secondly, about the problem of concentration and the problem of morphology in biological effects. Would there be some correlation between irradiation sensitivity of eucaryotic cell and the irradiation resistance of bacteria? Would this be related in some way to the amount of water, which is available to the biologically important molecules? Can you say something about that please. And second, we're dealing here I think, with polymers which are usually linear chains, possibly networks. I think we have to remember that probably the most important biological molecule for the survival of a cell is the DNA, which has a special morphology of its own. It is a very rigidly structured geometric target for irradiation and I would be interested if there were some philosophy on how this rigid geometry might alter irradiation effects, or shall I say the correlation between irradiation effects in polymers to the correlation of irradiation effects in the biological DNA.

Comment by:

A. CHARLESBY — England

No. I think as far as DNA is concerned, if it is a stiff molecule, it will depend on how free it moves so one part of the DNA molecule can match up with another part of the same molecule. If it's very rigid, obviously you cannot get a link between that and that if they don't see each other. So it will depend on the flexibility which, presumably depends on pH, among other things.

Concentration — Well, if a lot of water gets into the molecule, so the molecule swims freely, then it

will depend on concentration. But if you have got a fairly rigid structure with a limited, constant amount of water, then the answer will be no water dependence until you dry out the water which is already there. Obviously, if you got the molecule surrounded with a little bit of water inside it and a lot of water in the rest of its room, that is irrelevant, it is only the water in immediate contact, almost in immediate contact with the molecule, which can have any effect on it.

Comment by Moderator:

Of course this is a discussion of the isolated system, not of the DNA in the cell, which is different.

Comment by:

G. ADAMS — England

Can I present, if you will permit me, a little bit of philosophy about the relativity of talking about a response in the biological system and using simple radiation chemical models to explain. As someone who spends absolutely 50% of his time working either with mammalian cells or bacteria or doing pulse radiology in chemical systems, it has often struck me that where one might be concerned with a biological phenomenon and have to study it at the biological level, there are often instances where a question poses itself, which can be answered rigorously by a simple chemical system. It has been said: "If you go fishing you won't catch rabbit, but if you go fishing you will catch your fish". Let me illustrate the point. There was a very brief comment made by Dr. Schulte-Frohlinde this morning which was in regard to the migration of free radicals in sugar phosphate, which is a piece of work that has answered a very critical question in the mechanism by which a cell is inactivated. Let me elaborate: there is now of course, we will all agree, reputable evidence that the major process leading to the inactivation of a cell is the inactivation of the nucleic acid and the only definition we have of the death of the cell is that it does not divide and there is a lot of independence to this evidence, including cellular and non-cellular evidence, implicating DNA. There is also evidence that tells us that lethality and the efficiency of producing lethality is related to the formation of breaks in the DNA. Another piece of evidence — there is also something that tells us that damage originates somehow on the DNA base itself and yet, the break manifests itself in the sugar backbone. DNA does not exist alone in a cell at all. It exists as a complex with a protein and it was found that on irradiation of the nucleoprotein, there was very little degradation at the kind of doses that would produce major degradation of the free DNA. So that tells us then that water radicals originating outside the DNA-protein complex are relatively unimportant. So ask your selves a question in an inactivation of a cell. What was the origin of the damage that leads, at least the radiolytic damage, to the inactivation of the DNA? It cannot come from without, it has to be inside, and yet nucleoprotein does not contain much water. It is often said it is a very rigid system. So what is the mechanism then that leads to the production of breaks in the DNA strand that produces the effect that DNA cannot reproduce itself? Dr. Schulte-Frohlinde described something, which is a very crucial key link in that chain and it has come from a very basic radiation chemical system. He showed that if you produce a free radical in a sugar, a sugar phosphate, you break the phosphate sugar bond and there is a radical migration. It's also been shown in various kinds of simple irradiation chemical DNA systems where a free radical on a primary site in a purine base in a nucleotide, very easily abstracts the hydrogen from the sugar. That happens in DNA. And so there you have directly from two simple radiation chemical model systems, the explanation of how basic damage can lead to a break in a DNA

chain. So one might ask why is all this relevant anyway. And then, the biological information in some critical experiments is that only radicals on the five position of purine or pyrimidine bases are the ones that are very damaging to the cell. These were tritiated experiments in which cells are grown in the presence of tritiated uracil. If it's in the five position, there is a tremendous mutagenic effect; anywhere else there is not. That is because the five position is the only position in the base that is close to the sugar backbone. The radiation chemical experiments have shown how that radical can transfer itself to a sugar but nobody knew how it led to the phosphate, so as to lead to breakage. The work that Dr. Schulte-Frohlinde described this morning is in fact the evidence that this can take place. That is directly relevant to a cellular situation with a pure radiation chemical experiment and I think it passed almost without notice.

Comment by Moderator

I enjoy these kinds of discussions and one could really do much more about it. This is the proof of the death of the cell. This is the proof of the vitality of the cell. But really this would be a nice beginning of the next session.

Comment by Anonymous Speaker

I would like to ask Dr. Adams a question concerning his very interesting remark that only damages which directly occur in the DNA lead to the splitting of the bonds. That is, let me put it in a form of comment and then ask him if he agrees with it. My opinion is the direct effect on the DNA should lead to the production of free radicals. The interesting part in this respect is the number of the radicals formed this way, versus the number of radicals which would have been formed by the OH radical extraction on the DNA? So it would be very interesting to investigate the direct effect of the DNA and look at these radicals, and compare them to those radicals which are produced by OH effect, but in every case the pre-radical stage also occurs on the direct radiation of the DNA. I would like to ask if he agrees with this.

Comment by:

G. ADAMS — England

Well first of all, if you place a naked DNA in solution and irradiate it under conditions where you can permit reactions of hydroxyl radicals, only 10% of them will attack sugar; this is what you would expect from rate constants and, in fact, are damagable. So in the direct effect you are concerned with base damage, but if you have that DNA surrounded by nucleoproteins, the inactivation or rather the damage efficiency drops by two orders of magnitude. So this is one of the main reasons where I personally do not think that inactivation of DNA intercellularly arises from indirect processes outside that complex. So the next part of this question then is how do we know the damage originates on the base following the direct effects. That is where we have to fall back on the experiments of the mutagenic effect of tritiating DNA inside the cell. There are two sets of experiments I'm aware of — one is with bacteria, the other is with *Drosophila* and they fed the creatures tritiated uracil in the five position or the six position. In the five position the mutagenic effect was enormously greater. I think, a factor of 13 or so in the case of the fruit fly, and the efficiency of this process was comparable, in terms of free radical locations, to the efficiency of ionizing irradiation. Now in the tritiated case, in the incorporation,

it is not the radiation phenomena, it is the transmutation which leads to a free radical and they can calculate the span of the free radical from the per cent of the tritium which is incorporated. Yet the efficiency of producing the irreversible biological changes is comparable to that of ionizing irradiation. And that is tenuously, may be — the evidence that the direct effect in intercellular situations does occur at the base level.

Comment by Anonymous Speaker

Very briefly I would like to present another philosophical view on the subject which is slightly different from that of Dr. Adams. It is more the view of a physical chemist, which is closer to Dr. Charlesby's view. I think that, as Dr. Charlesby pointed out, polymers are very good models, oversimplified, but still a model of a living cell. We ignore in a polymer all the processes which lead to restoration, metabolism and so on, and perhaps this is why we understand slightly better what is going on.

Now coming back to a living system, the physical chemist realizes that a living system is a terribly complicated physical chemical system in a very tiny equilibrium state. You can kill a living cell, not only by cutting the DNA, but you can kill it simply by introducing some poison in its environment or by removing from its environment some vital components, and there are many many other means to kill a cell. What we find is that the response of a living system very much resembles, in a very broad sense, in a very good way, the response of a polymer. If a living organism takes a dehydrated state like in its score, it becomes terribly resistant to irradiation. It becomes terribly resistant to the environment. And this is true for polymers. A dry polymer in a glassy state will accept a lot of free radical formation without much damage, because the free radicals are immobilized. The same applies for water. Water is a very peculiar chemical with respect to irradiation chemistry, in the sense that it produces OH radicals and H radicals, and H radicals in the presence of oxygen give rise to HO₂ radicals. Now both OH and HO₂ radicals very efficiently abstract hydrogen from any organic substance. So we have this induced, or as radiobiologists called it for a long time, indirect effects of irradiation, where active species produced in water attack the substrate and produce the damage. So without going into the details of the chemistry of DNA, and from the previous discussion, I simply would like to recall that there is a guideline which is still very good, and without going into the details of the chemistry, we simply see that OH radicals, HO₂ radicals formed from water are amongst the active species which will attack a polymer or living polymer cell and produce damage at some point.

FOURTH SESSION

Chairmen

D. Schulte-Frohlinde

F. Antoni

Moderator

F. Antoni

Present Status and Future Prospects for Radiation Sterilization

R. S. M. Frohnsdorff

Gillette Research & Development Laboratory, U.K. 450, Basingstoke Road, Reading, Berks, England.

Introduction

Now that this symposium is in its final session, I have been asked to look into the future and to raise topics that may, it is hoped, provoke discussion. It must be remembered that today is tomorrow's yesterday and, for this reason, I propose to look back as well as forward. Unlike many of the previous speakers who have described research in the radiation field, my comments are the result of experience derived from the application of large scale industrial sterilizing procedures to medical products. Whilst previous research had been in other areas, a little over ten years ago I was asked to review techniques that could be useful for sterilizing single use medical devices. At that time we did not have detailed knowledge of the products that would be treated, but were aware that serious problems could arise from steam sterilizing in the hospital environment⁴⁴.

It is obvious that the production of sterile products must involve either (i) aseptic manufacture or (ii) inactivation of contaminating micro-organisms by a chemical or physical process as a terminal sterilizing treatment. To inactivate a micro-organism, it is necessary to interfere with one or more of the essential chemical reactions that take place in the cell. A number of reactive chemical substances can do this, as can the absorption of sufficient energy to have a chemical effect¹¹.

The problem that is always present is that the reactive chemicals or the severe physical conditions that are certain to kill bacteria may also have an adverse effect on the materials from which a product or its package are made⁵². Whilst in theory absolute certainty of sterility is required, in a real situation it is necessary to make a judgement decision which takes into account (i) the possible level of initial microbial contamination, (ii) the certainty of sterility required for the product in the hands of the user³⁰, (iii) possible adverse effects the sterilizing process might have on the materials of construction, and (iv) the cost. The objective must be to give the greatest benefit to the ultimate user, frequently a sick patient, and if there are shades of difference in opinion, it is in the weighting that individuals put on the relative importance of these four factors. With the different situations which are met in practice there are factors which will always be in conflict to some extent and there can be no sterilizing process which is always superior to all others. It is not my intention to discuss this wider subject, but Table 1 summarises the considerations which are particularly relevant to sterile medical devices which are to be made in large volume.

Table I. — Comparison of Industrial Sterilizing Processes

Feature	Heat Processes	Ethylene Oxide	Gamma Radiation	Electron Radiation
Critical physical parameters to be monitored for process control	Time	Time		Time
	Temperature	Temperature		
	R.H.	R.H.	Time	Complex electrical controls for: electron energy dose rate band spread scan pattern
	Pressuer	Pressure		
	Vacuum	Vacuum		
		E.T.O. conc.		
Microbiological Control (B.I.s)	Desirable	Essential	Not required	Desirable
Post stabilization treatment	Dry product	Air to remove toxic residues	None	None
Problems of scaling up process	Difficulties increase	Difficulties increase	No problem. Improved efficiency	Essentially final rate process
Sterilizer loading	Spacing critical	Spacing critical	Approx. uniform density required	Position on belt critical
Product mix	Single product	Single product	Mixed product	Single product
Product design	No sealed cavity	No sealed cavity	No restriction	Should have laminar form
Materials of construction	Must be stable to heat	Most materials satisfactory	Most materials satisfactory	Most materials satisfactory
Packaging	Porous material essential	Porous material essential	Hermetic seal possible	Hermetic seal possible
Probability of product sterility	Good	Fair	Excellent	Good if overtreatment possible

In an age of ever increasing technological change, we have seen radiation sterilization develop from a concept to a major industrial process in a decade. Ten years ago it was the possibility of food sterilization that excited the major interest. With the enormous demand for food preservation, even a small proportion of the total could have been of the greatest significance. Work has been carried out in many countries and continues to this day. Nevertheless, for a number of reasons, the early promise has not been sustained. There has been no doubt about the effectiveness of sterilization, but the issue of cost has not been satisfactorily resolved. Also with materials of such complex chemical structure and with popular opinion involved, it has been extremely difficult to prove that any change, which may only reveal itself over a long period of time, does not have an adverse effect.

About the time that I was reviewing sterilizing procedures, the U.K. atomic energy program had reached an interesting stage of development. Some years earlier a decision had been made for this country to leave the nuclear arms race and to concentrate on peaceful applications. The main programs had already achieved initial success in the power field, and large installations had been built for electrical power generation. A variety of radioactive elements particularly in the middle range of atomic number were available as waste products, and attention had been turned to a search for potential applications. A special laboratory was set up by the U.K.A.E.A. at Wantage for this purpose³⁶.

An alternative to fission products was radioactivity induced by neutron capture. Steel of low activity was first considered, but it was then realised that cobalt activated by neutrons whilst itself acting as a

moderator during the commissioning of power reactors would, in fact, be a more practical source. Radioactive cobalt-60 subsequently became readily available in more than adequate quantity for commercial exploitation. It was found that convenient techniques of encapsulation could be developed so that the material could be easily handled.

I have been told that G. S. Murrey first suggested the deliberate manufacture of cobalt-60 as a radioactive source material and may therefore be credited with the industrial sterilizing which has brought us all to Vienna this week.

A versatile production package irradiation plant was designed and constructed at Wantage²⁹. It was the availability of this government-financed plant that enabled many industrial companies to carry out experiments with a variety of products in the early sixties. At that time the concept of single use medical devices was in its infancy in the U.K. In the U.S., however, such products were already established and were being sterilized by the only other significant cold process which was ethylene oxide gas¹⁸. Although initially slow to find commercial acceptance it is interesting that this process also owed much to government support at a critical time. Gas sterilization was developed for the sterilization of space vehicles.

In recent years there have been considerable advances in aseptic handling techniques and the construction of laminar flow assembly areas⁶. It is, however, a general opinion that terminal sterilizing processes are either preferred or essential when a high degree of assurance of product sterility is required. Considering terminal sterilization it is probable that the cheapest processes involve heat. If moisture is also present it is possible to use somewhat lower temperatures, although 120-130°C is still required. A sterilizing process, however, is only part of the total manufacturing operation and an overall objective must be to make the finished product at the lowest overall cost consistent with the quality required. As heat is so destructive to many pharmaceuticals and the materials most suitable for the construction and packaging of high quality medical devices it is usually found that low temperature processes are strongly to be preferred for terminal sterilization.

It has been known for a very long time that all ionising radiations can inactivate micro-organisms⁴² and it appears that the first major application was the sterilization of sutures. Initially using a 2MeV electron accelerator it was established that 2.5 Mrads was a suitable dose to inactivate a range of some 150 organisms⁴. In the U.K. it was a fortunate coincidence that the development of an industry to produce sterile single use medical devices followed, rather than preceded, the proven feasibility of industrial radiation sterilization. At about this time gamma radiation was, in fact, replacing high energy electrons in suture manufacture⁵. Sutures are, of course, an excellent illustration of the unique advantages of gamma radiation; a high level of microbial inactivation of a natural product is required, coupled with the minimum loss of strength of the material. There is apparently less degradation with gammas than with electrons⁴³.

Some of the most obvious advantages of gamma sterilization to the manufacturer are the ability to monitor the process by physical means, to sterilize through a considerable mass of hermetically sealed packages and the highly predictable nature of the results²⁰. These technical advantages, when combined with reasonable cost predictions, were, in my opinion, the substantial reasons a decade ago for recommending a gamma sterilizing facility as potentially the most versatile process for medical devices. Nevertheless, it must be emphasised that it would be wrong to imply that other sterilizing methods are always inferior and it will occasionally be found that an alternative process could, in fact, be preferred

under particular circumstances.

Electron Sterilization

In the 1950's it was generally thought that electron accelerating machines, either Van deGraaff or linear accelerators, would be of considerable importance for sterilizing⁴⁰. In spite of the convenience of being able to switch the plant on when required, this early interest in electrons has not been maintained. There are now 46 electron accelerators in the U.K. alone, but there is still only one sterilizing commercial quantities of medical supplies⁶⁴. It appears that the electron sterilizers treating significant volumes of medical supplies in the world today can be counted on one hand. The reason for this limited utilisation is readily understood by examination of the absorption of energy as the radiation passes through a homogenous material. Figure 1 is the familiar illustration of the absorption of 1 MeV electrons in water.

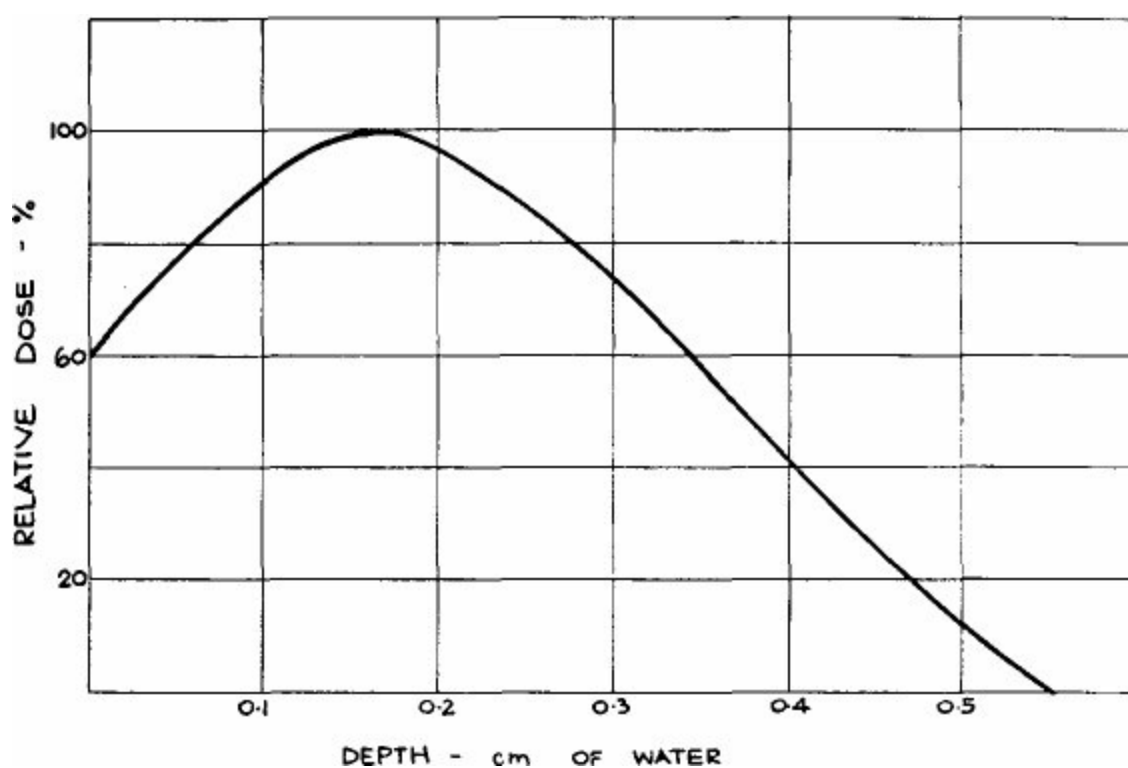

Figure 1. Penetration of electrons — 1 MeV.

There is both a limited depth of penetration and very uneven absorption. For the majority of products and packages, unless in a perfectly laminar form, it is quite impossible to define the energy that has been absorbed. There have been many attempts to minimize this fundamental difficulty in applying and accurately monitoring the absorption of electron energy across a beam and through an irregular mass of product²⁷. I do not wish to dwell unduly on these very real problems, which are well understood. At the present time the majority of electron accelerators are not in fact used for sterilization but are used to cure surface coatings or to effect chemical modification of plastic films. These are always applications where long runs of uniform materials have to be treated and it is only under such conditions that it is possible to calibrate and monitor the absorbed dose with reasonable accuracy. In the area of sterile products, absorbent and adhesive dressings are the obvious areas of application.

In addition to the gross variation of absorbed radiation with depth penetrated, the normal spread of the beam will give a distribution of the form shown in Figure 2.

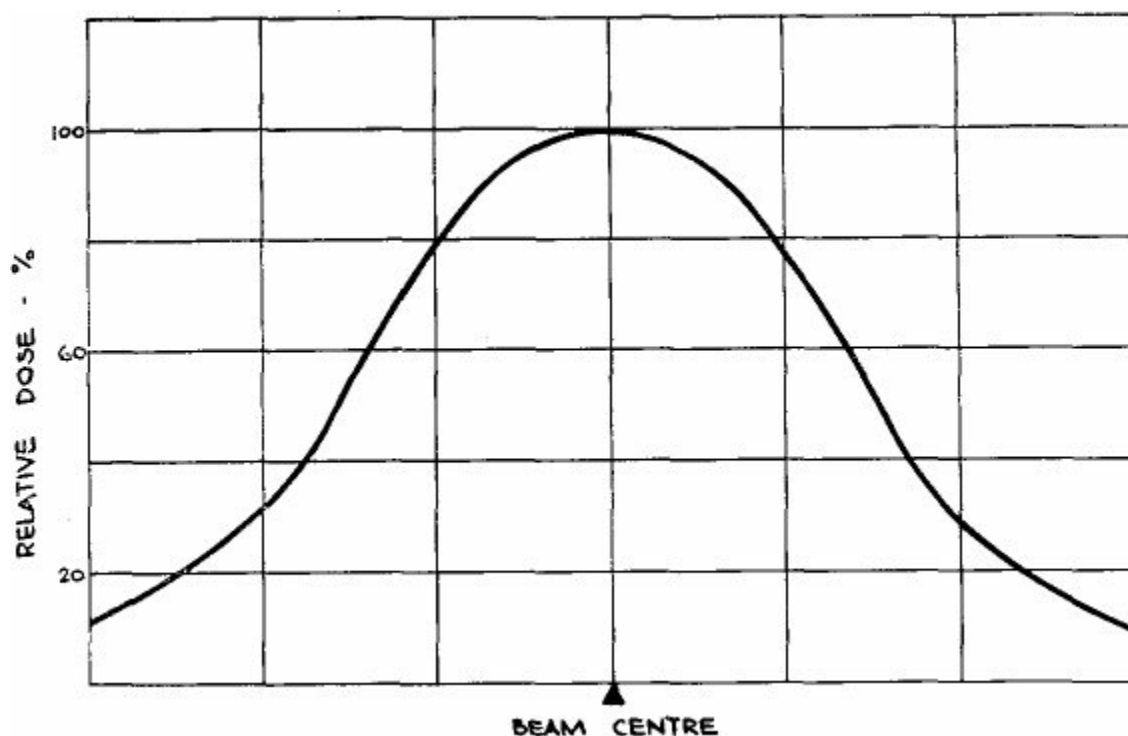

Figure 2. Lateral dose distribution from unscanned electron beam.

A more satisfactory band spread may be obtained by scanning the accelerator output. The form of the wave scan is critical, but it should be possible to obtain an average energy distribution of the type shown in Figure 3 across the band width.

In practice, of course, the film or product conveyor will also be moving continuously past the scanned beam. If the rate of scan is high compared with the rate of traverse of the product conveyor a uniform treatment is possible. This need not always be so and particularly with very intense electron beams the rate could become critical if either overtreatment, due to beam overlap, or undertreatment if the product is moved too fast, are to be avoided.

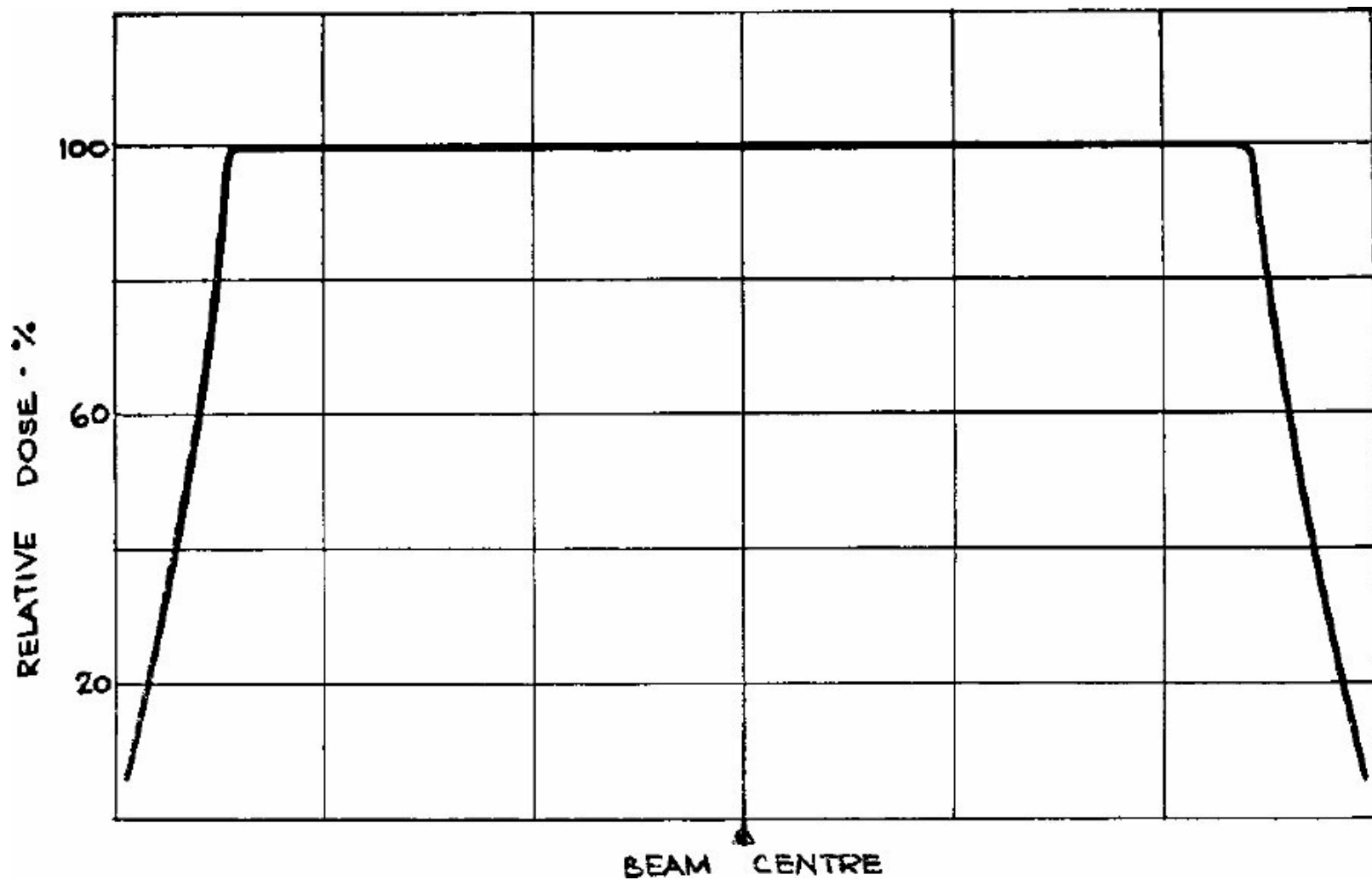

Figure 3. Lateral dose distribution from scanned electron beam.

With pulsed beams from a linear accelerator there can be an additional problem of ensuring that microsecond pulses at say 500 per second do not become linked with a scanning rate which may be 50 per second¹³. If every micro-organism is to be inactivated it must be capable of proof that the radiation field is uniform down to the size of one micron, the size of one organism. To illustrate these thoughts and possibly to exaggerate the effect of speed of movement on a scanned beam, Figure 4 has been prepared. Undoubtedly it may be possible to avoid these problems by electrical adjustments, but the reason that attention has been drawn to the possibility is that techniques are not available to monitor the uniformity of energy absorption within some orders of magnitude of the micron scale required.

Table II. — Dose Rate in Typical Commercial Radiation Plants

Source of Radiation	Approx. Dose Rate in Mrad/sec
Cobalt-60	0.01
Van de Graaff	250
Linear accelerator	125,000 (during pulse)

Although the primary absorption of radiation is independent of dose rate, the chemical and biological changes which follow can be affected in the LET (linear energy transfer). With electrons the LET will be higher than for gammas and due to the proximity of free radicals or ion pairs along the electron path radical interactions may be more important than other reactions which may involve

solvent or oxygen molecules. For this reason electron treatment can result in changes similar to treatment in an anoxic environment. The figures in Table II give an indication of the relative dose rate in typical commercial irradiators.

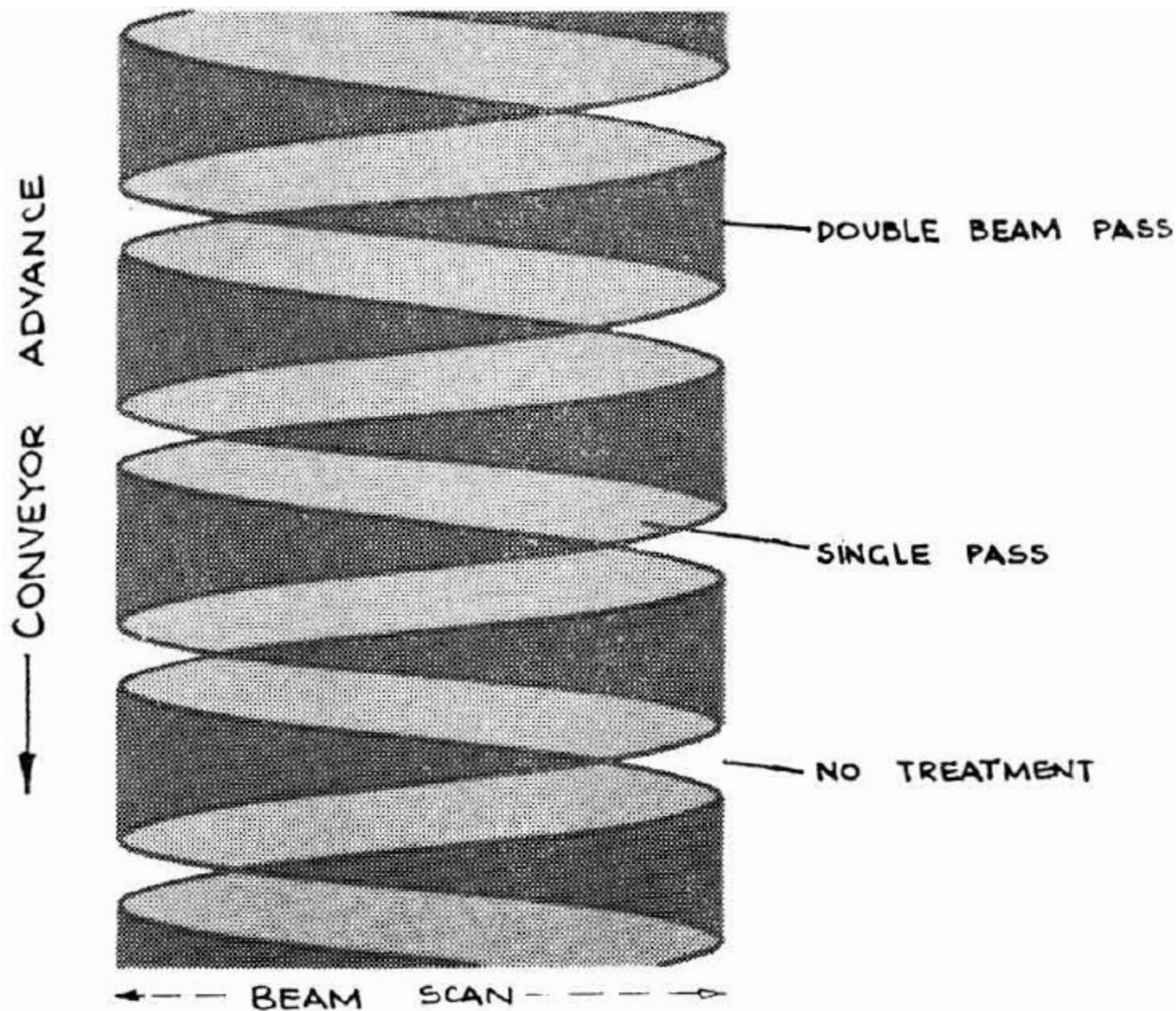

Figure 4. Dose distribution under scanned electron beam.

Under anoxic conditions the degradation of some plastics may be reduced¹⁶ but it is also possible to predict that the bacterial inactivation would also be significantly less⁹. It is known that irradiation in an inert atmosphere can reduce the inactivation of some bacteria²⁴. Possibly for this reason it has been reported that the sterilizing dose for electrons should be about 10-20% higher than for gamma¹⁷.

There are a number of elaborations of the electron process devised to minimise the inherent problem of uneven dose absorption. These include double or multiple pass arrangements, beam splitting, partial degradation of the energy by passing through a screen made from an element of low atomic number or the generation of more penetrating X-rays by allowing the electron beam to interact with a heavy metal². All of these complications of the process, however, must cause further difficulties in making accurate measurements and in monitoring of the radiation dose actually absorbed by all parts

of the product. There is one further problem which has been reported, and that is that electrons tend to build up a negative charge on some plastic surfaces which repels the approach of further electrons and, particularly with irregularly shaped articles, thus produces an even greater imbalance of energy deposition than already predicted³⁷.

For these many technical reasons I do not foresee any great future for electron treatment for the sterilization of medical devices. However, manufacturers treating uniform materials will undoubtedly extend the present limited use of the process. It is understood that the frequently reported problems associated with short tube life have now largely been overcome and, with the ability to switch the process on and off when required, electrons have an advantage when it is necessary to link the sterilizing process with other manufacturing plant.

Gamma Sterilization

Being uncharged, gamma radiation has the great advantage of uniform absorption through considerable volume of product²⁸. Product and package geometry has very little effect. The comparison between the penetration of gammas and electrons is clearly illustrated by Figure 5.

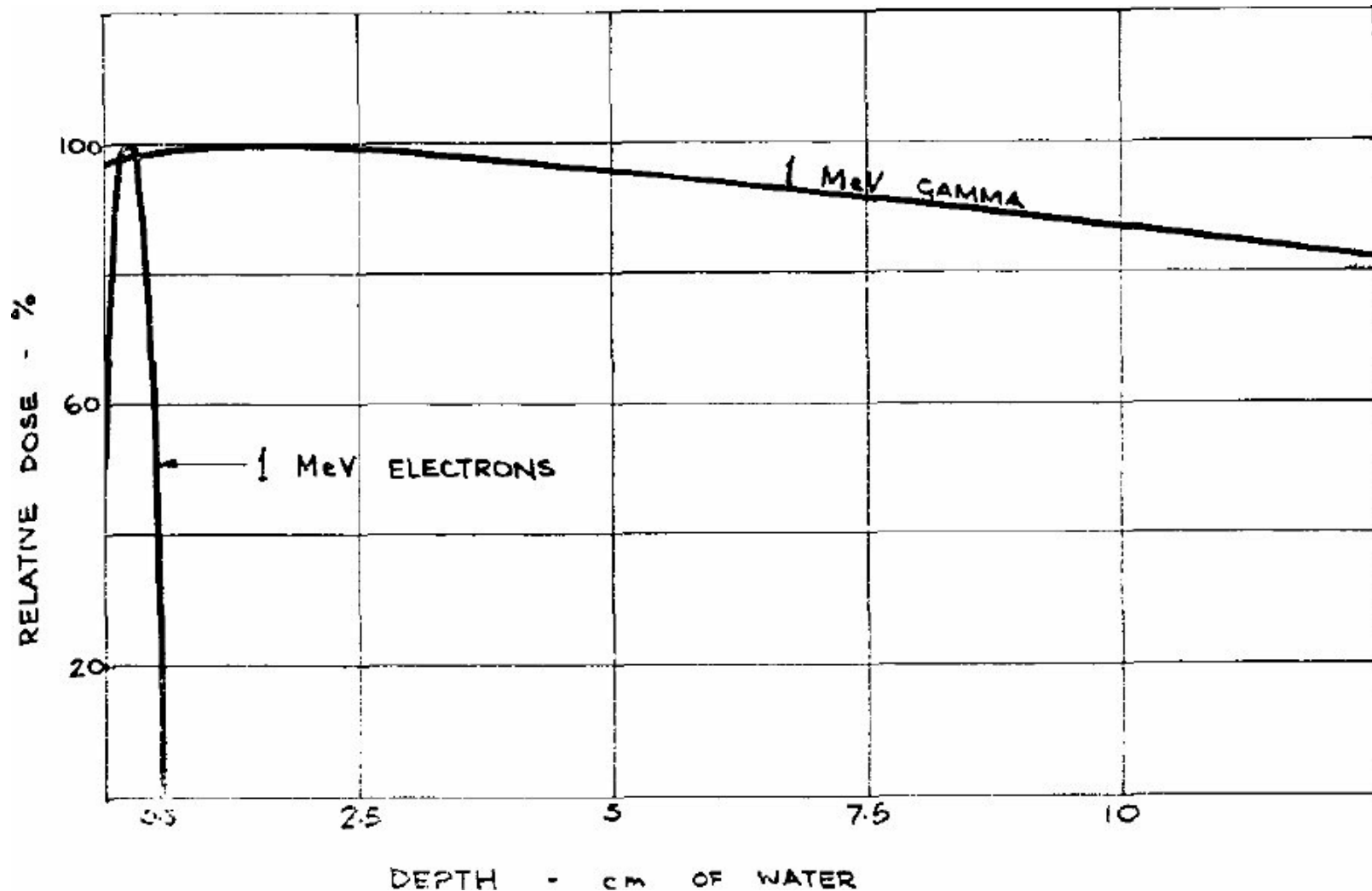

Figure 5. Comparison of penetration of gamma radiation and electrons.

Where the gamma process is chosen there is a much greater versatility and, provided sensible precautions are taken, a wide range of products and packages can pass through the same plant with complete certainty of the dose of radiation that has been absorbed. The process control is

straightforward and it is possible to have several independent checks of the dose absorbed²¹. Once the source has been calibrated there is no outside influence that can affect the radiation emitted, and time of exposure and plant geometry alone control the dose. Herein lies one process limitation, for the facility is best when operated continuously. It is only the large manufacturer with a reasonably constant flow of products for sterilization who can program output to make the most efficient use of the facility. There are some process companies that have been set up to treat other manufacturers' products on a contract basis, but in such cases there are programming problems which lead to significantly less economic operation.

Table III. — Commercial Gamma Sterilising Plants

	Location	Company	Date	Nominal Capacity × 1,000 ci.
UNITED KINGDOM	Slough	Johnson & Johnson Ltd.	1961	750
	Edinburgh	Ethicon Inc.	1962	200
	Reading	Gillette Industries Ltd.	1963	750
	Sheffield	Swan-Morton Ltd.	1966	100
	Tilehurst	Gamma Radiation Services	1970	1,000
	Lancing	Eschmann Bros., & Walsh Ltd.	1971	120
	Swindon	Irradiated Products Ltd.	1972	1,000
UNITED STATES	San Angelo	Ethicon Inc.	1964	1,500
	Somerville	Ethicon Inc.	1964	1,500
	Morton Grove	Gamma Process Co.	1967	200
	New Canaan	Becton, Dickinson & Co.	1969	1,000
	Lake Denmark	Radiation Technology	1970	1,500
	Dover	Radiation Services Assocs.	1970	100
AUSTRALIA	Dandenong	Gamma Sterilization Pty. Ltd.	1960	2,000
	Lucas Heights	Radiation Research Lab.	1969	
	Melbourne	Tasman Vaccine Lab.	1971	1,000
	Sydney	Johnson & Johnson Pty. Ltd.	1972	1,000
ITALY	Bologna	ICO S.p.A.	1967	500
	Rome	Ethicon, S.p.A.	1968	100
	Bologna	Gammamad Italia	1970	1,000
	Bologna	Irrad. S.p.A.	1971	2,000
	Como	Gamatom S.p.A.	1971	1,000
SWEDEN	Gottenburg	Radona AB	1968	1,000
	Rotebro	Johnson & Johnson	1971	1,000
WEST GERMANY	Hamburg	Ethicon GmbH	1966	500
	Melsungen	Braun Co.	1966	600
	Rommelshausen	Willy Rusch AG	1968	1,500
CANADA	Peterborough	Ethicon Sutures Ltd.	1964	100
	St Hilaire	Isomedix Ltd.	1972	400
FRANCE	Lyon	Conservatome Industrie	1960	900
	Saclay	Conservatome Industrie	1962	500
	Lyon	Conservatome Industrie	1968	300
	Lyon	Conservatome Industrie	1974	1,500
ARGENTINA	Buenos Aires	Comision Nacional de Energia Atomica	1970	1,000
DENMARK	Roskilde	Nune A/S	1969	1,000
	Copenhagen	Novo A/S	1971	1,500
HOLLAND	Utrecht	Gammaster	1970	1,000

INDIA	Trombay	Indian Dept. of Atomic Energy	1966	100
	Trombay	Indian Dept. of Atomic Energy	1973	1,000
ISRAEL	Yavne	Sorvan Irradiation Ltd.	1972	1,000
JAPAN	Takusaki	Japan R. I. Irrad. Service Co-op	1972	300
NEW ZEALAND	Upper Hutt	Tasman Vaccine Lab.	1966	1,000
SPAIN	Barcelona	Spanish Atomic Energy Commission	1972	
BELGIUM	Mol	C.E.N.	1969	100
NORWAY	Kjeller	I.A.E.	1969	100
SOUTH AFRICA	Palindaba	S.A. Atomic Energy Board	1971	1,000
SWITZERLAND	Schwarzenback	Inrescor	1968	100
	Neuhausen	Soc. Ster. Catgut	1972	200
CZECHOSLOVAKIA	Brno	Kove State Textile	1972	300
GREECE	Athens	Lefkippos S.A.	1972	250
IRELAND	Dublin	Becton, Dickinson & Co.	1974	1,000

The first major industrial plants were constructed in the early sixties in the U.K. and U.S. Recently there has been a considerable increase in plant construction. Table III has been compiled listing commercial gamma plants used for medical products, of which I have some knowledge, either directly or from following the literature. In this table the majority of small installations mainly used for experimental work are not included and neither is information freely available of plant in Eastern European countries. Whilst the list may not be complete or accurate in every detail, it does indicate the scale on which gamma sterilization is being carried out today. When compared with their nominal capacity, many of the plants of recent construction are lightly loaded with radioactive source material, although cobalt loadings are increasing rapidly.

It is interesting to analyse this information and the accelerating rate of plant construction since the middle sixties has been very obvious. This information is given in Table IV.

Table IV. — World Gamma Sterilizing Plant Capacity

Year	Plants constructed	Total	Nominal Capacity Ci × 1000	Total Ci × 1000
1960	2	2	2,900	2,900
1961	1	3	750	3,650
1962	2	5	700	4,350
1963	1	6	750	5,100
1964	3	9	3,100	8,200
1965	0	9	0	8,200
1966	5	14	2,300	10,500
1967	2	16	700	11,200
1968	5	21	3,000	14,200
1969	4	25	2,100	16,300
1970	5	30	5,600	21,900
1971	8	38	7,620	29,520
1972	8	46	5,270	34,790
1973	1	47	1,000	35,790
1974	2	49	2,500	38,290

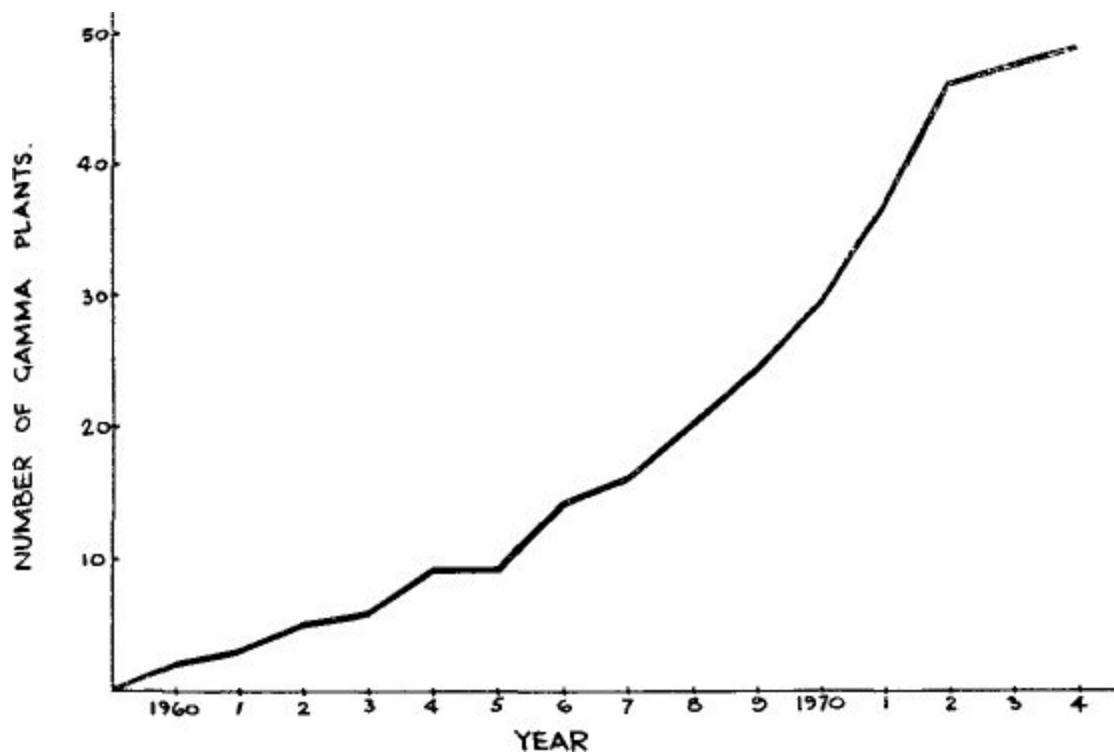

Figure 6. World gamma sterilizing capability.

It will be seen that there is now a commercial gamma sterilizing capability in 22 countries round the world as detailed in Table 5. It is known that there are at this time further plants under consideration, and there is reason to believe that growth of potential sterilizing capacity will continue. As plant capacity frequently greatly exceeds the present use, the nominal plant capacity does not necessarily indicate the scale on which the process is currently being used in a particular country but must indicate the use that can be expected within the next few years.

It is estimated that at present there is about 10.5 Mci of cobalt 60 in the plants listed in Table 3. Of this source material about 7 Mci is in Europe, 2.5 Mci being in the U.K.⁶⁷ At this time the overall loading of existing plant capacity is greatest in the U.K. and currently is about 70% of the theoretical maximum.

The expansion of radioactive source material is likely to increase rapidly for a number of years. Only in the U.K. have significant segments of the sterile medical supplies market been converted to irradiated products. However, radiation sterilization is firmly established in France, Scandinavia, Holland, Germany and Italy. In Europe the market for disposables should more than double between now and 1980. In the U.S., following problems with other sterilizing processes, there are marked changes taking place with considerable interests turning to irradiation. It has been reported that the value of irradiated products in 1970 was approximately \$100,000,000 and this is predicted to increase to \$500,000,000 in 1975⁶⁹. There is insufficient published information to quantify the conversion to irradiated products in other countries but it may be expected to follow the lead of the more developed markets. Based on the assumption that the major large scale use for cobalt-60 will continue to be the sterilization of medical supplies, a survey carried out for the U.S. Atomic Energy Commission has indicated the probable annual requirement for gamma source material. This is illustrated by Figure 7 and it is predicted that the annual requirement for cobalt-60 should reach 16 Mci by 1980 and possibly could be higher⁷⁰

Table V. — Distribution of Gamma Sterilizing Capacity

Country	Maximum Capacity of existing Plants × 1,000 curies
United States	5,800
Italy	4,600
Australia	4,000
United Kingdom	3,900
France	3,200
West Germany	2,600
Denmark	2,500
Sweden	2,000
India	1,100
Argentina	1,000
Holland	1,000
Ireland	1,000
Israel	1,000
New Zealand	1,000
South Africa	1,000
Canada	500
Czechoslovakia	300
Japan	300
Switzerland	300
Greece	250
Belgium	100
Norway	100

Due to the attitude of a number of national health authorities and the increasing scale of industrial manufacture it is probable that a large proportion of the world supply of factory-made sterile medical devices will be sterilized by radiation within a few years. In a modern plant it will be found that it is possible to sterilize about 10 lbs. of product a year for each curie of cobalt-60 installed. Alternatively, for easy calculation it may be assumed that each curie decayed will have treated some 7.5 cu. ft. of product during its life. To give some idea of the scale of operation in our plant alone we have treated 3,750,000 cu. ft. of medical products and if all commercial plants are being operated with reasonable efficiency there should now be something approaching 100,000,000 lbs. of medical supplies irradiation sterilized each year.

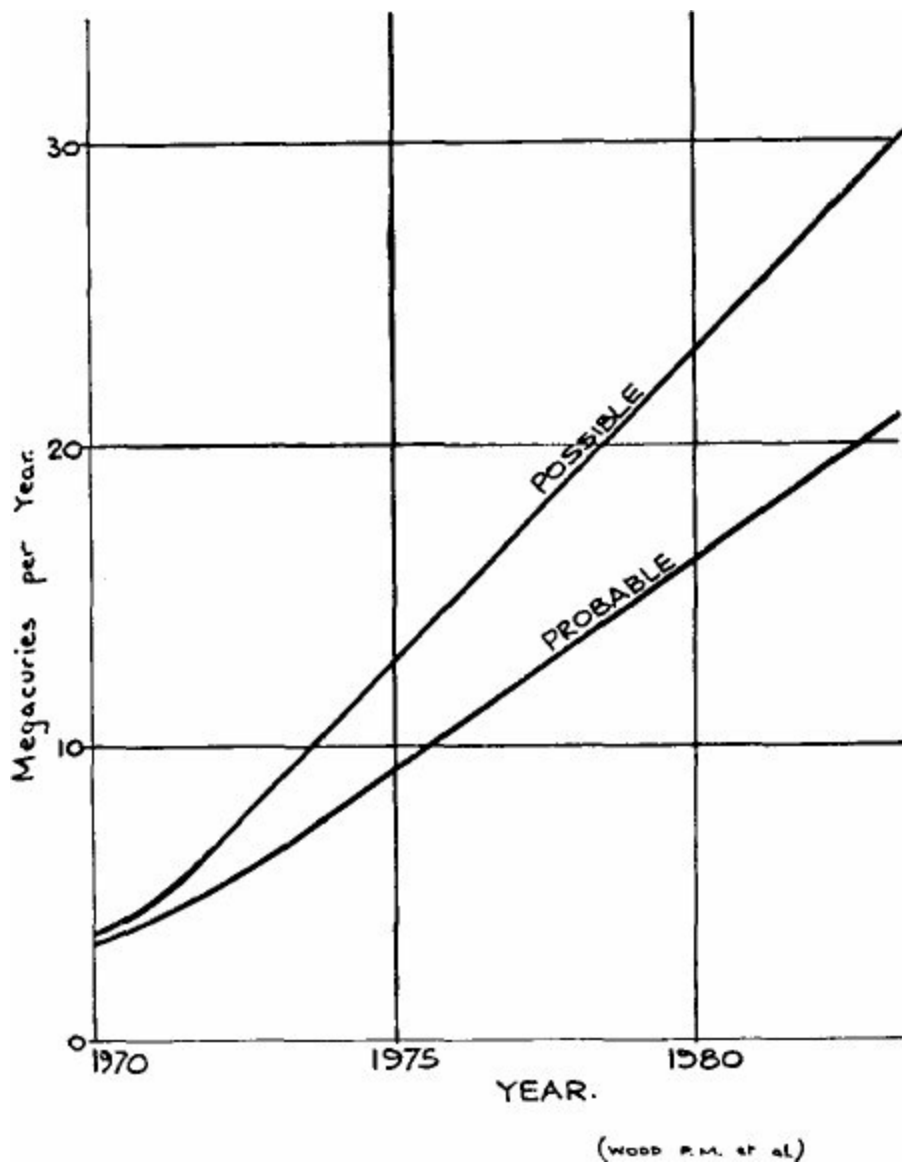

Figure 7. Potential annual demand for gamma source material in terms of cobalt-60.

To this time there is no doubt that cobalt-60 has proved to be the most useful radioactive source material, and the specific activity of the material has increased progressively. In 1962 rods of 5 ci/g were being offered. Today 30 ci/g is more common, and there is no difficulty in providing 50 ci/g, if required. Means of producing rods of higher activity continue to be of interest. In an ingenious process of activation, a cobalt spring is extended whilst exposed to neutrons and then relaxed to give a rod of high activity.⁵⁶ This concept is also of interest as it is possible to adjust the specific activity of a source element to a predetermined level by simply extending the spring.

As source material of higher activity becomes available, so it is possible to increase throughput and reduce the time that the product is held within the plant. Nevertheless, due to the nature of the gamma process and the very high penetration of the radiation, it is still necessary to maintain a substantial volume of product around the source and it must also be remembered that higher activity can also increase problems associated with heat dissipation. A small frame of high activity cobalt will give a less uniform energy absorption through a large mass of product.

Economics strongly favour a large plant, as the capital requirement changes little with source size, whereas throughput increases in direct relation. It is a general opinion today, that 1 Mci is close to the optimum. At 1 Mci the source material has become the major cost element and even lower operating

cost has to be set against the reduced flexibility of the manufacturing operations. It must also be appreciated that there is a significantly increased hazard if too high a proportion of a factory output is tied to one piece of manufacturing equipment.

In theory there are many other radiation source materials, but in practice the choice is limited⁴⁵. The waste material from power reactors has been used to a limited extent³³ but the very variable nature of such radiation, both with respect to energy and half-life, immediately defeats the main advantage of the process which is predictability. The element that is at present the most economically viable alternative to cobalt-60 is cesium-137. It is available in considerable quantity, usually in the form of a cesium-134/137 mixture, in radioactive wastes, although it is desirable to allow time for much of the cesium-134, half-life 2.2 years, to decay. cesium-137 has a half-life of 22 years, compared with the 5.3 years of cobalt-60, and emits a gamma ray of energy, 0.66 MeV; cobalt-60 emits two rays of energy, 1.16 and 1.23 MeV, respectively.

Cesium has been used in France since 1963 but is still only available in limited quantity. To obtain large quantities a considerable investment in chemical separation equipment will be required¹⁴. In this respect when considering the large investment that would be required one remembers the ill-fated Isochem project. Due to the high self absorption of cesium-137 source elements and the lower energy of the radiation, cesium-137 could probably only compete if its cost per curie was less than one quarter that of cobalt-60. The chemical reactivity and water solubility of cesium chloride, the usual radioactive form of the element, also makes it less attractive on safety grounds. It is particularly difficult to encapsulate and the greater heat generation is an additional problem.

Unless there is a change in technology in some other part of the nuclear industry which affects the relative cost, it seems unlikely that an alternative to cobalt-60 will become available in the foreseeable future. The particularly attractive features of cobalt-60 are ease of handling, safety and there can be no induced radioactivity or pollution from its use.

Irradiation Environment

For the control of irradiation sterilization it is agreed that it is only necessary to consider two factors, the dose absorbed and the pre-sterilization microbial contamination³⁰. Under most circumstances there is a large safety margin in bacterial inactivation; there is also a safety margin as far as adverse effects on materials of construction are concerned. This need not always be the case, however, and it has been shown that the environment during irradiation can have a significant effect²³. The influence of dose rate has been referred to previously. It was noted that at the very high rates achieved with electrons there can be an approximation to an anoxic condition, which may produce a detectably different result. The energy of electrons will also have an effect on the pattern of the energy dissipated through any three dimensional product.

When considering electromagnetic radiation from a radioactive source, the energy will generally be constant, and it will have a biological effectiveness determined only by total dose. No value can be seen in the suggestion that a new gamma installation should be monitored at commissioning with biological indicators. However, the biological effectiveness of other types of electromagnetic radiation ranging from U.V. to the various X-rays, may be influenced by both the mean energy and the energy distribution that is supplied⁵³. Biological checks at commissioning would therefore seem desirable in such cases.

There are two other environmental factors which can be controlled in a relatively straightforward manner, particularly for the gamma process. These are temperature and the composition of the gaseous phase which will normally surround the product. It has been shown very clearly that not only are heat and irradiation sterilization mutually compatible, but they may, in fact, be synergistic for the inactivation of both bacteria⁶⁰ and viruses⁶⁶. An extensive program has been carried out at the Sandia Laboratories. This work which was based on a study of the inactivation of bacteria and enzyme systems appears to be of very general application. Whilst the heat and irradiation parts of the process can be carried out separately, it is obvious that simultaneous treatment is more effective. To illustrate the synergism that has been demonstrated for the inactivation of *Escherichia coli* by the thermo-radiation process by the N.A.S.A. workers the graph, Figure 8 is reproduced. In this example 50 °C and 25 krads/hr gamma radiation was used. A considerable theory for thermoradiation has already been developed and it is possible to predict the ranges of temperature and radiation dose rates that should be used. With this information it should be possible, if the need arose to tailor a sterilizing procedure to suit a particularly sensitive product which otherwise could not be presented in sterile form.

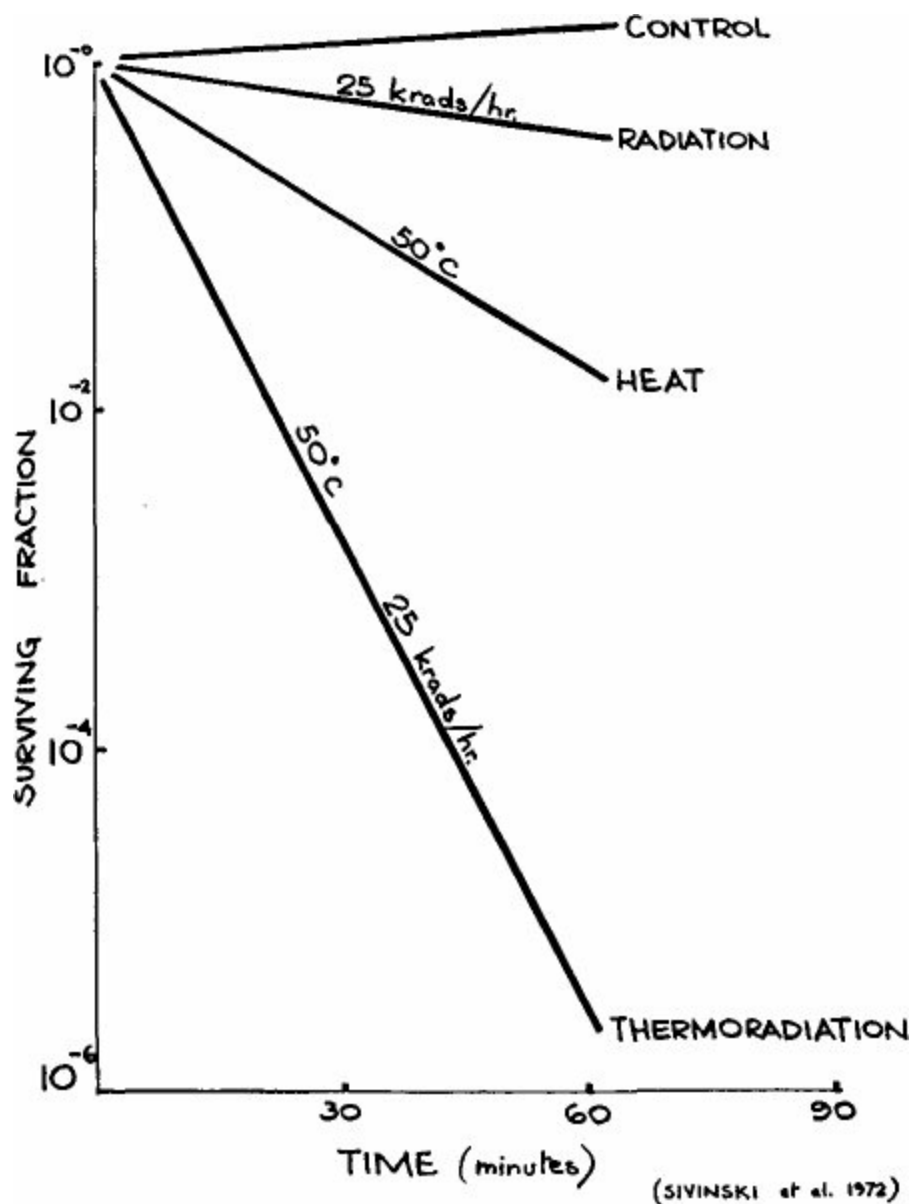

Figure 8. Thermoradiation of inactivation of *Escherichia coli*.

It is also well known that the gaseous environment can have an effect on bacterial inactivation. Both

moisture and the presence of oxygen are of importance. It has been demonstrated for many organisms that the "D" value, the irradiation dose to reduce the viable population by one log cycle, is higher in the absence of oxygen. Desiccated organisms also have a slightly higher resistance.

The environment can also influence the effect of radiation on some plastics. Again, the same two factors are of the greatest significance and study of the literature will show many examples. A material that has been examined in great detail is polypropylene. Radiation effects on this material are well understood²² and it is known that the free radicals initially generated react with oxygen, causing further changes in mechanical properties. The degradation can be followed conveniently by changes in the melt flow index, or by the molecular weight, as illustrated by Table VI.

Table VI. — Effect of Atmosphere on Degradation of Polypropylene

Condition	Molecular Weight
As molded	220,000
Irradiated in nitrogen atmosphere	159,000
Irradiated in air	102,000

With few exceptions the control of the environment during radiation has not been exploited under production conditions. It seems probable, however, that there will be occasions when a controlled atmosphere will offer advantages. Perhaps the sterilization of pharmaceuticals or natural products, where the high value and greater sensitivity to degradation, might give the extra incentive to depart from the traditional treatment in an uncontrolled environment.

There has been much discussion of the biological effect of a split sterilizing dose. The literature has been reviewed⁶² and it is found that in general there is no change in the lethal effect of irradiation, although under special conditions both increased and decreased inactivation have been noted. Only the latter could be of concern to the user of the radiation process, but the possibility does not seem to be important. A contrived laboratory experiment where partially irradiated cells are allowed to grow on a nutritive medium during the inter-irradiation interval is needed to demonstrate the possibility.

A number of chemicals which either inhibit or enhance¹⁰ the effect of irradiation on both micro-organisms and plastics⁵¹ are known but a discussion of these effects is too detailed for the present paper. The environmental effects that influence the result of irradiation are summarised in Table VII.

Table VII. — Variation of Sterilization Environment

Factor	Inactivation of micro-organisms	Deterioration of materials
Dose rate (low)	No effect	No effect
Dose rate (very high)	Less inactivation, similar to anoxic condition	Less damage, similar to anoxic condition
Broken dose	No effect unless in growth environment	No effect
Energy and type of radiation	Affects penetration and uniformity of treatment	Affects penetration and uniformity of treatment
Temperature	Increased effect, synergism possible	Can influence secondary reactions
Anoxic conditions	Less inactivation possible	Less damage to some materials
Dehydration	Less inactivation possible	Less damage possible
Additives	Both inhibitors and sensitizers known	Both stabilizers and sensitizers known

Process Requirements

It is believed that the standardization of the sterilization dose at 2.5 Mrads in most countries^{48,68} since it was first proposed in 1957 has greatly helped the process find acceptance. Being new technology, the collaboration of all interested parties in defining codes of practice has been a distinguishing feature of radiation processing and the U.K. Panel on Gamma and Electron Irradiation has certainly set a useful pattern of collaboration between manufacturers, health authorities and independent scientists. This has been extended in the international field by groups within the International Atomic Energy Agency, as well as such bodies as the Biological Indicators Committee of the U.S. Pharmacopeia Convention and the Commission of the European Communities Industrial and Technical Affairs⁵⁷.

The wide acceptance of a standard sterilizing dose has also been of great advantage to both plant operators and the regulatory health authorities, for with the mixed product throughput in many commercial plants it is usually impossible to treat products differently. The certainty of the process giving product sterility under most varied conditions has been extensively validated by the records built up over the years by many companies³.

Related to the sterilizing dose is the overdose ratio, which is a most important irradiation plant parameter and takes into account both plant design, box size and product mix. Based on a decade of plant operation, it is our experience that by careful attention to both programming of the plant load and monitoring the dose received, 2.5 Mrad can be applied with a standard deviation of ± 0.10 Mrads. Under such conditions the minimum/maximum dose ratio can be as low as 1:1.25, but an occasional article may still receive 3.0 Mrads. Inevitably, in a manufacturing operation a small amount of packaging will be damaged, and when repacking is allowed such a product will have to be passed through the plant again. It is, therefore, a normal requirement that a product to be sterilized to a nominal 2.5 Mrads will be tested to 5.5 Mrads during the development program if unacceptable restraints are not to be imposed on production.

As mentioned in the introduction, it is necessary to reconcile four somewhat conflicting factors to give the greatest advantage to the ultimate user. The opinion is held that we rightly tend to an overkill situation as far as sterilizing dose is concerned, at the expense of deterioration of materials, and the elimination of otherwise desirable materials of construction. Whilst less well informed of the situation outside the U.K., it is known that Inspectors of the Department of Health and Social Security do insist on the highest standards of hygiene in product assembly areas. Products assembled in laminar flow clean air rooms have low levels of microbial contamination, generally less than 10 viable organisms per product¹². To assist in predicting a product safety margin⁶³ we have long monitored products with a sub-sterilizing dose of 0.25 Mrads, and at this level a surviving organism is rare³⁵. In the future, whilst 2.5 Mrads will continue to be regarded as the satisfactory dose for most medical products it is possible that there should be more flexibility in suiting dose to the product. When a product is made in areas of exceptional hygiene, or from sensitive raw materials, a lower dose could be beneficial, but this would obviously require that additional monitoring be carried out. These remarks apply particularly to some pharmaceuticals and products of biological origin.

It has frequently been suggested that a reasonable standard for factory-made products is that the chance of finding a non-sterile article should not exceed one item in a population of 10^6 (Ref. 41).

Whilst this may be reasonable, it should be remembered that the possibility of a sterile article remaining uncontaminated during extraction from the package and in its subsequent use is several orders of magnitude less, and is probably no better than one in 10^2 (Ref. 31). To select the appropriate sterilizing dose for any product and particularly a sensitive one, it is good practice first to identify the contaminating organisms encountered under the actual conditions of manufacture. From the inactivation factors of these organisms it is possible to compute the sterilizing dose required to give an acceptable safety factor, bearing in mind the expected end use of the product.

Applications of Irradiation Sterilizing

If there is any doubt about the significance of irradiation sterilization it is only necessary to look at the various abstract journals to see the widespread interest and volume of publication. A detailed manual on radiosterilization has recently been compiled by the International Atomic Energy Agency¹. No longer is study restricted to a few well known centres but is spread around the world. This is especially relevant to the application of irradiation to practical problems and there is no possibility of making an adequate review in this short paper of all the suggestions that have been made. Nevertheless, a few indicative comments will be made on each of the main sterilizing areas.

Food

The potential application of radiation to food sterilization is vast and much of the research funding was originally justified for this reason⁵⁸. Very active programs have been carried out and continue in both advanced and underdeveloped countries but a general acceptance of irradiated food has yet to be achieved⁶⁵. There is no more reason to expect any immediate breakthrough now than there was ten years ago, although there continue to be some minor commercial ventures with a variety of foodstuffs. Comparatively low radiation doses improve the storage characteristics of many easily perishable items.

There are, however, two food applications where irradiation has become established. These are (a) the diet of experimental animals bred and reared in sterile environments and (b) the sterilizing of the food required for human patients undergoing treatment in isolated sterile rooms. A complete meal may be frozen, irradiated and reheated when required.

Agriculture

Many agricultural possibilities and actual uses for radiation treatment exist ranging from sterilization, prevention of germination, improvement of storage characteristics and the removal of rodent and insect infestation⁵⁴. Such sterilization is considered outside the scope of this paper.

Medical Devices

The major interest today in radiation sterilization is the treatment of medical devices. This will continue to be the growth area in the immediate future. The value of the principal disposables in the European markets alone is predicted to increase from about \$500,000,000 in 1971 to \$1,200,000,000 in 1980.

There cannot be a class of disposable medical items that has not been radiation sterilized. We can all make long lists of the items being processed under production conditions and there is no reason to

doubt that within a few years a large proportion of single use devices and many other disposable items will be radiation sterilized. Table VIII list some classes of product which are known to be regularly treated.

Table VIII.

Syringes and needles
Gloves
Catheters and tubes
Sutures and needles
Procedure trays
Disposable garments, covers, drapes, etc.
Surgical dressings, bandages and adhesive plasters
Blood taking and transfusion equipment
Inhalation therapy equipment
Specula, scopes and other diagnostic equipment
Prostheses, intrauterine pessaries
Containers, bottles, petri dishes, etc.
Surgical instruments, scalpels, forceps, etc.
Cardiac valves

In general the larger the volume of production the greater the advantage of irradiating. It is possible to use a higher standard of packaging and to improve the guarantee that can be given of the maintenance of sterility under adverse conditions of storage. Apart from improved product protection it will frequently be possible to design more functional packaging. Although on occasion a raw material problem will arise, there should in the future be few large volume devices introduced to the market which have not been designed with radiation sterilization in mind.

Pharmaceuticals

There has been an increasing interest in the contamination of pharmaceuticals and microbiological purity will become of greater importance as the new standards are introduced. A considerable literature already exists on the effect of high energy radiation on pharmaceutical materials, but the situation is complex. There is agreement that all major health authorities will consider an irradiated drug as a new material requiring evidence of efficacy and safety. Some irradiated pharmaceuticals are known to be in regular production⁸ particularly a number of eye preparations, enzymes from glandular extracts and veterinary products. If it is possible to generalize, it seems that materials formulated in an oily base, or in the dry powder form⁴⁶, are less likely to be adversely affected than aqueous preparation⁴⁹. For this reason it is possible that sterile injectable products may be offered in the form of a dry powder, separated from the correct volume of solvent. There are many patents, so far unexploited, for syringe designs based on this principle.

For unsterile pharmaceuticals it is understood that the European Pharmacopeia may place a limit on the number of microorganisms for each pill or milliliter of oral preparations. Whilst the preparation may be given a light terminal sterilization, it is more likely that highly contaminated components will be given a clean-up irradiation dose followed by aseptic mixing and packing. There are already a number of pharmaceuticals being irradiated without any claim for sterility. A dose of about 1 Mrad may be typical for such applications.

There may well be an opportunity for irradiation plant designers to produce small plants with greater dose flexibility in the range 0.5-5.0 Mrads suitable for such applications in pharmaceutical companies. The large gamma plant is frequently not suitable for these applications. As a product could be treated in powder, solution or pill form, a thin uniform film of product could be formed which would be convenient for electron treatment²⁵.

Vaccines and sera

Radiation has been shown to be a useful means of inactivating a number of disease producing viruses^{50,59}. The antigenic properties and immunizing power of the resulting vaccine is often unaffected⁶¹. It has also been reported that the toxicity of the antigens derived from irradiated bacteria may be lower than for heat inactivated products. Terminal sterilization of a vaccine may be used as a means of improving the manufacturing technique and avoiding some of the complications of aseptic handling and filling. A number of snake venoms have been studied and it is possible, by suitable selection of dose to detoxify the venom without inhibiting its ability to induce the formation of antibodies⁵⁵.

Biological tissues and related materials

Many unique possibilities exist for the use of radiation as a means of sterilizing a wide range of tissues⁴⁷. A Central Tissue Bank in Warsaw uses radiosterilization for materials which may then be stored at room temperature. It is also possible to sterilize tissue in the frozen state. Amongst the human parts which can be successfully treated in this way are bone, cartilage, blood vessels, fascia, meninges and tendons, nerves and heart valves⁷¹.

Toiletry and cosmetic products

In a number of countries standards exist and there is a move towards legislation limiting microbiological contamination of cosmetic products³⁴. Radiation has already been used in a few instances as a clean-up procedure. For this purpose a sterilizing dose may not be required; alternatively it may be more convenient to sterilize a contaminated component such as starch or talc before formulation.

Waste and effluent treatment

The environment is becoming a subject of concern and particularly in the United States an interest in possible applications of irradiation to pollution problems has arisen in recent years¹⁹. Economic considerations are all important to large scale projects, such as arise in sewage schemes or waste disposal. There is an increasing availability of waste from nuclear power programs and hence a large potential availability of radioactive fission products⁴⁵. A very detailed study carried out for the Stanford Group of Hospitals in California has indicated that the sterilization of infectious wastes by gamma radiation prior to dumping, could be superior to incineration on both cost and environmental grounds³⁹.

Hospital sterilizers

Single user license provided by AAMI. Further copying, networking, and distribution prohibited.

Whilst many hospitals make limited use of commercial contract sterilizing facilities for special items,

the possibility of installing an irradiation facility in group central supply departments has frequently been considered. Such a facility is being provided for military supplies in the U.K. and a plant is being constructed for the Western Hospital in London, Ontario, Canada⁷.

There are, however, problems associated with the insidious degradation of some plastic materials which could be a problem. Unless carried out on a large group basis and including such bulk items as dressing and linen, it seems unlikely that a hospital project could be economically viable.

Conclusions

In the immediate future it is clear that the main use and growth of radiation sterilization will continue to come from the medical products area. From the point of view of the large industrial manufacturer the advantages of the process are so considerable when compared with the alternatives that everything is in its favour. The advantages are summarised in Table IX.

Table IX. — Reasons for Continued Expansion of Industrial Gamma Sterilization

Large throughput, continuous operation and no scaling up problem.
Simple, slow-moving, rugged equipment requiring little maintenance.
Lowest cost cold sterilization process.
A large part of the total cost (radioactive source) can be programmed with predicted throughput.
Great certainty of product sterility.
Superiority of products and packages appreciated by users and Health Authorities.

Whilst the rate of expansion will vary from country to country, within a few years it is to be expected that all of the present installations will reach a level of utilisation at present found only in the U.K. This will give some 30 Mci capacity even without the addition of new plants which are already under construction or are being considered. After allowing for the cobalt-60 required to make good source decay, the present annual rate of growth of radioactive source material is about 5 Mci and this rate of expansion may be expected to continue through to the 1980s. The potential availability of cobalt-60 would seem to be in excess of probable requirements.

There is still a need for more knowledge of the effect of radiation on materials of all types. Serious deterioration of materials used to construct and pack medical supplies is not common but can be insidious as there are instances where deterioration only becomes apparent after prolonged storage. It is strongly recommended that no irradiated products should be permitted to be used until stringent tests have been carried out to check that no mechanical deterioration has occurred which could affect function.

The wide acceptance of the safe sterilizing dose in most countries will continue to be an important factor in promoting the growth of the process and also increasing international trade in medical devices. A more flexible approach to sterilizing dose, both down and perhaps also up, will be required if sterile pharmaceuticals and biological materials are to be treated successfully with minimal degradation. The potential for growth in these areas is considerable but less certain at this time and existing plants are generally not very suitable for such applications.

Apart from a few special applications where material in laminar form has to be treated there does not seem to be much advantage in using electrons for sterilizing purposes. It is a strongly held opinion that once a manufacturer has decided to commit the substantial capital required to install a radiation

sterilizing facility, products and packages should be tailored to suit the process. In this way the few problem materials may be avoided. Product design, package design and sterilizing process are so strongly interrelated that they should always be considered together when developing safe and functional medical devices.

Referring to the potential additional outlets for the sterilizing properties of radiation outside the medical supplies industry it is more difficult to make rational predictions. The reasons for the timing of the exploitation of new technology are obscure. Enthusiastic and informed support is first needed but the relative economics compared with alternative processes is also an important factor. For radiation the economic prospects are improving all the time with the expanding nuclear energy program in many countries. Unlike most other raw materials the radioactive source materials used for sterilizing are by-products of the nuclear energy business. World supply must inevitably exceed the predicted demand. Under these circumstances competition should at least minimize the escalating costs that occur in almost every other area today. With this happy note I conclude this presentation, but reiterate that overriding other considerations, the demand for the highest product quality and safety is the main reason for the continued rapid expansion of radiation sterilization of medical products. To the environmentalist also gamma sterilization is a particularly attractive process.

References

1. Agranenko, V., Antoni, F. (1973). *Manual on Radiation Sterilization of Medical and Biological Materials*, Int. Atomic Energy Agency, Vienna. Tech. Report No. 149.
2. Anon (1960). Industrial processing applications of electron beam radiation. *The Engineer*, **8**, 15-22 January.
3. Artandi, C. (1972). Microbiological control before and after sterilization: its effect on sterility assurance. Int. Atomic Energy Agency Working Group. Riso, 5-9 June.
4. Artandi, C., Van Winkle, W. (1959). Electron beam sterilization of surgical sutures. *Nucleonics*, **17**, No. 3, 86-90.
5. Artandi, C., Van Winkle, W. (1965). Comparison of electron beam and gamma-irradiated plants. *Isotopes and Radiation Tech.* **2**, 321.
6. Austin, P. R., Timmerman, S. W. (1965) *Design and Operation of Clean Rooms*. Business News Publishing Company.
7. Atomic Energy of Canada (1973). *Annual Report* (March).
8. Bartha, T., Hangay, G., Haraszti, M. (1970). Radiation sterilization of an ophthalmic ointment containing hydrocortisone and chloramphenicol. IV Bacteriological aspects. *Acta Pharm. Hung.* **40**, 226-32.
9. Bridges, B.A. and Horne, T. (1959). The influence of environmental factors on the microbicidal effects of ionizing radiations. *J. Appl. Bact.* **22**, 96-115.
10. Bridges, B. A. (1969). Sensitization of organisms to radiation by sulphhydryl-binding agents. *Advanced Radiation Biology*, **3**, 123-76.
11. Coggle, J. E. (1971). *Biological Effects of Radiation*. Wykeham Publications (London) Ltd.
12. Cooke, A. M., Berry, R. J. (1967). Pre-sterilization bacterial contamination on disposable hypodermic syringes. Necessary information for the rational choice of dose for radiation sterilization. Int. Atomic Energy Agency Symposium, Budapest, 5-9 June.
13. Crowley-Milling, M. C. (1960). The application of radiation to industry. *Proc. Inst. of Electrical Engineers* **107A**, 111-126.
14. Cusack, J., Manowitz, B. (1972). Comparative characteristics and values of cobalt-60 and power reactor 134-137 Cs mixtures. *Trans. Amer. Nucl. Soc.* **15**, No. 2, 692.
15. Dietz, G. R. (1971). Contract sterilization by radioisotope irradiation. *Bulletin Parenteral Drug Ass.* **25**, No. 5, 252-6.
16. Dole, M. (1973). Oxidation of Irradiated Polymers. In *the Radiation Chemistry of Macromolecules, II*. p. 263-279. Academic Press.
17. Emborg, C. (1972). Influence of preparation technique, humidity and irradiation conditions on *Streptococcus Fecium strain A21*. *Acta Pathol. Microbiol. Scand. Sect. B.* **80**, No. 3, 367-72.
18. Ernst, R. R. (1972). "Ethylene oxide gaseous sterilization for industrial application. *Proc. Int. Symp. Amsterdam*. p. 181-208.
19. Fowler, E. E. (1972). New trends in isotope application techniques in the U.S. *Proc. Jap. Conf. Radioisotopes* No. 10. p. 13-22.
20. Frohnsdorff, R. S. M. (1968). The design of packages for irradiation sterilized products. U.K. Panel on Gamma and Electron Irradiation Symposium, Ditchley Park. 22 April.
21. Frohnsdorff, R. S. M. (1972). Experience derived from the operation of a large cobalt 60 irradiation plant. Int. Atomic Energy Agency Working Group, Riso, 5-9 June.
22. Geymer, D. O. (1973). Polypropylene. In *the Radiation Chemistry of Macromolecules*. Vol. II. p. 1-28. Academic Press Ind.
23. Goldblith, S. A. (1967). General principles of radiosterilization, Int. Atomic Energy Agency Symposium, Budapest, 5-9 June. p. 3-22.
24. Gray, L. H. (1959). *Radiation Research Supplement*. Vol. 1. p. 73.

25. Greene, R. E., Warren, H. S., Baker, P. S. (1971). *Patent Literature on Process Radiation and Irradiator Design Part I*. U.S. Patents 1950 through 1968. Contract W-7405-eng-26.
26. Greene, R. E., Warren, H. S., Baker, P.S. (1971). *Patent Literature on Process Radiation and Irradiator Design Part II*. British and Canadian Patents 1950 through 1970. Contract W-7405-eng-26.
27. High Voltage Engineering Corporation (1959). High Voltage Electron Beam Processing. Technical Bulletin P.
28. Jefferson, S. (1963). *Massive Radiation Techniques*. Georges Newnes Ltd.
29. Jefferson, S. et al (1961). *Atomic Energy Waste; its Nature, Use and Disposal*. ed. Glackauf. Chap. 5. p.l. Butterworths.
30. Kallings, L. O. (1967). Review of the code of practice for the radiosterilization of medical products. Int. Atomic Energy Agency Symposium, Budapest 5-9, June.
31. Kallings, L. O. et al (1966). Microbiological contamination of medical preparations. *Acta Pharm. Suec.* **3**, 219.
32. Kendra, E. J. (1970). Production experience in a cobalt 60 irradiation plant for sterilization of disposable medical products. *Chem. Eng. Progr. Symp. Ser.* **66**. No. 106. p. 42-7.
33. Kuhl, O. A. et al (1964). Isotopic sources of radiation power. ed. A. Charlesby. *Radiation Sources*. Pergamon Press.
34. Ley, F. J. (1971). Gamma radiation for product sterilization. *Jour Soc. Cosmetic Chem*, **22**, No. 11, 711-23.
35. Ley, F. J. et al (1972). Radiation sterilization: microbiological findings from sub-process dose treatment of disposable plastic syringes. *J. Applied Bacteriology*, **35**, No. 10, 53-61.
36. Longstaff, R., Grant, J. (1971). Gamma irradiation as an industrial process and Britain's role in its development. *J. British Nuclear Energy Society*, **10**, No. 3, 229-36.
37. McCann, J. D., Rogers, F. (1963). Difficulties in obtaining uniform dose distribution throughout electron-irradiated plastic mouldings. *Nature* **200**, No. 4912, 1195.
38. McCluskey, R. J. and Welt, M. A. (1971). Radiosterilization of surgical supplies in the medical field. *Surgical Business*, February. p. 32-36.
39. McKee, R. W., Owzaski, P., Butcherite, C., Frymer, J. (1973). Feasibility of a large gamma radiator as a hospital sterilization facility. Contract AT (45-1) — 1830. Battelle Pacific Northwest Laboratories. January 17.
40. Miller, C. W. (1954). Application of high energy electrons to the sterilization of pharmaceuticals and the irradiation of plastics. *J. British I.R.E.* **14**, No. 12. 637-652.
41. Miller, W. S. (1972). Industrial sterilization control. *Proc. of Int. Symposium Amsterdam*. 26-27 Sept.
42. Minch, F. (1896). Zur Frage über die Einwirkung der Röntgenschen. Strahlen auf Bakterien und ihre eventuelle therapeutische Verwendbarkeit. *Munch. med. Wochenschr*, **43**, 101.
43. Molnar, I., et al (1967). Sterilization of catgut by ionizing radiation. Int. Atomic Energy Agency Symposium, Budapest 5-9 June.
44. Nuffield Hospital Trust (1958). *Studies of Sterile Supply Arrangements for Hospitals — Present Sterilizing Practice in Six Hospitals*.
45. Ohtsuka, N. (1972). Use of fission products as radiation sources. *Proc. Jap. Conf. Radioisotopes*. No. 10. p. 244-246.
46. Pandula, E., Farkas, E., Nagymaldi, A., (1970). Study of radiation-sterilized drugs and their aqueous solutions. *Parmazie*, **25**, 254-258.
47. Panel Report (1969). Sterilization and Preservation of Biological Tissues by Ionizing radiation. Int. Atomic Energy Agency Symposium, Budapest, 16-20 June.
48. Phillips, G. O. (1972). A consideration of the international Atomic Energy Agency recommended code of practice radio-sterilization of medical products. Int. Atomic Energy Agency Working Group, Riso. 5-9 June.
49. Phillips, G. O., Power, D. M., Sewart, M. (1971). Effects of gamma irradiation on sodium sulphacetamide. *Radiation Res.* **46**, No. 2, 236-50.
50. Pieceas, M., Arizan, D., Hlevca, B. (1968). Inactivation of influenza virus with gamma radiation. *Stud. Cercet. Inframicrobial.* **19**, No. 6, 425-7.
51. Pinkerton, D. M. (1971). Effects of nitrous oxide and ethylene on the gas yields and gel formation from gamma-irradiated polypropylene. Defence Standards Lab., Maribyrnong, Australia.
52. Plester, D. W. (1970). Effects of sterilizing processes on plastics *Bio-Medical Engineering*. **6**, 443-7.
53. Powers, E. L. et al (1959). Modification of sensitivity to radiation in single cells by physical means. *Progress in Nuclear Energy Series IV*, Vol. 2. Biological Sciences, p 189-198.
54. Prokofev, N. S. (1973). Economical efficiency of the introduction of gamma ray irradiated plants into agricultural practice. *Isotopenpraxis*, **8**, No. 5, 168-170.
55. Purananda, C. (1971). Studies on effects of radiation on snake venoms with special aspects on their sterilization. Final Report for the period Sept. 1968-30 Nov. 1971. Int. Atomic Energy Agency.
56. Ransahoff, J. A. et al (1972). Method for the production of cobalt 60 sources and elongated hollow coiled wire target therefor. *U.S.P.* **3, 594**, 275.
57. Rispal, C. (1968). *Operation Irad. on the Promotion of Applications of Irradiation Techniques*, Lyon, May 3 - 12. Commission of the European Communities Industrial and Technical Affairs.
58. Sato, T. (1971). Present status on food irradiation in Europe. *Japan Atomic Energy Research Inst.* April.
59. Saradoc, Y., Cepleanu, M., Burdicea, O. (1968). "Action of gamma radiation on measles virus. *Stud. Cercet. Inframicrobiol.* **19**, No. 6, 437-40.

60. Sivinski, H. D., Garst, D. M. Reynolds, M. C., Trauth, C. A., Trujillo, R. E., Whitfield, W. J. (1972). The synergistic inactivation of biological systems by thermoradiation. Int. Industrial Sterilization Symposium, Amsterdam.
61. Sullivan, R., Fassolitis, A. C., Larkin, E. P., Read, R. B. Jr., Peeler, J. T. (1971). Inactivation of thirty viruses by gamma radiation. *Applied Microbiology* **22**, No. 1, 61-5.
62. Tallentire, A. (1973). Microbiological consequences of dose fractionation. Special Report U.K. Panel on Gamma and Electron Irradiation.
63. Tallentire, A., Dwyer, J., Ley, F. K. (1971). Microbiological quality control of sterilized products: evaluation of a model relation frequency of contaminated items with increasing radiation treatment. *J. Applied Bacteriology*, **34**, No. 3, 521-34.
64. Tattersall, K. (1967). Discussion to paper — Operation of an irradiation centre specializing in the sterilization of medical and surgical supplies. Int. Atomic Energy Agency Symposium, Budapest 5-9 June. p. 379.
65. Tauber, M., (1972). Irradiation of large-scale manufactured goods in the food and feeds industry. *Ind. Obst-Gemeuseverwert* **57**, No. 11, 295-300.
66. Trujillo, R., Dugan, V. L. (1972). Synergistic inactivation of viruses by heat and ionizing radiation. *Biophys.* **12**, No. 1, 92-113.
67. U.K.A.E.A. (1973). Private discussion.
68. U.S. Pharmacopeia XVIII (1970).
69. Welt, M. A. (1970). Radiosterilizing medical supplies. Disposable Soft Goods 10.
70. Wood, P. M., Harrel, H. A. (1971). Potential market for by-product cesium from commercial power reactors. AECOP 754, AEC Combined Operations Planning, Oak Ridge, April 29.
71. Wright, K. A., Trump, J. G. (1970). Co-operative studies in the use of ionizing radiation for sterilization and preservation of biological tissues — twenty years experience. Int. Atomic Energy Agency Symposium, Budapest, 16-20 June, p. 107-118.

General Discussion

Comments by

S. JEFFERSON

While we are discussing the future, I would like to make some remarks about the development of electrical machines and cobalt-60 plants restricted to their use in sterilizing medical equipment.

Please let me first outline the background to my forecast. Most people in the irradiation business consider me to be a cobalt-60 man. However, my basic training and experience have been in electrical engineering.

From 1935 I was involved in the radar program, which produced the magnetrons and klystrons, which paved the way for linacs. When I set up the Wantage Research Laboratory in 1955, my first action was to order a linac and we finally had 2 MeV and 5-15 MeV accelerators, as well as several D.C. machines in the range 150-300 keV.

All this makes me very sympathetic with the enthusiasm and ingenuity of the designers of machines which offer much more scope for development work than do to relatively mundane cobalt installations. However, the industrial user of ionising radiation is not concerned about elegant designs, but is far more interested in reliability that is well founded on simplicity. I therefore believe most firmly, that the future in industrial sterilization belongs to cobalt-60 plants.

One estimate of future costs shows that at very big throughputs, an X-Ray machine might be cheaper than an equivalent cobalt-60 plant, but would anyone, responsible for such a throughput, be prepared to depend upon a single machine? A reserve machine would help but would reverse the cost comparison to one in favour of cobalt.

The most compelling comparison is not between machines and cobalt-60 plants that are operating but between the situations which arise on breakdown. Faults on machines are, in general, much more difficult to remedy and may involve lengthy removal and replacement of gas and possibly damage from electrical breakdown. The relatively rare stoppages on cobalt plants are almost entirely simple mechanical troubles on the slow-moving conveyor. The different character of the faults means that the staff needed to remedy them are of quite different training and availability. The staff needed with machines are relatively rare and furthermore, need to be given a project to fill in the time while the machines are working. On the other hand, the cobalt plant conveyor faults are within the competence of the engineering staff, which already exist in most industrial concerns.

The conclusions drawn from experience are that on the average machine faults are more frequent,

take longer to remedy, and call for more expensive staff. These are the reasons why some operators have changed over from machines to cobalt, but none, as far as I know, has moved in the other direction.

Comments by

K. H. MORGANSTERN

I am delighted to have a chance to speak to you with respect to radiation processing in general.

To give you an idea of how excellent Johnson & Johnson's organizational talent is, they have me sitting on the same side of the table with Mr. R. S. M. Frohnsdorff, who, as you have heard, is very strongly disposed toward the virtues of cobalt-60 for medical product sterilization.

I wanted to speak for a few moments about the other side of the coin — namely the use of electron beam accelerators. I find that in almost all other radiation process areas, electron beam accelerators appear to be the preferred radiation source.

Perhaps using historical hindsight, one can account for the medical disposable industry's bias in favor of gamma rays rather than machines — a situation which, as I mentioned, appears to be unique to the medical disposable industry. As I see it, this is due in large measure to the very poor results which were accomplished with machines some fifteen or twenty years ago. However, I believe it is important to recognize that those early machines represented first generation equipment and considerable changes have taken place in the interim time period. These changes involved substantial increases in beam power, dramatic improvement of equipment reliability, and an over-all reduction in radiation costs.

It is precisely these changes to which I would like to direct your attention.

Certainly, success of any radiation process hinges to a large extent on its economics. Obviously with respect to medical disposables a need exists and consequently a market is here; to the manufacturer what is most important is how efficiently he can produce the product and penetrate the market profitably.

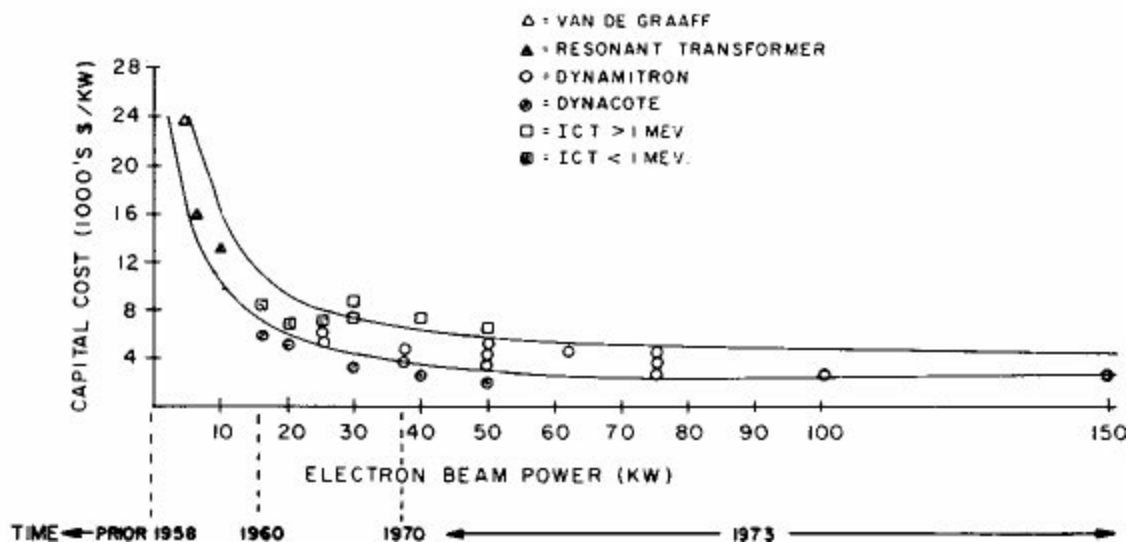

Figure 1. Capital cost vs. power and time.

There has been little discussion on radiation costs, yet probably in no other area has the change been as dramatic as it has been in the cost associated with radiation processing over the last decade. To put this in perspective, Figure 1 indicates what has happened over the period from 1958 to 1973 with respect to capital cost per installed kilowatt. As you will note, it has dropped from about \$24,000 per

kilowatt in 1958 to approximately \$2,000 to \$3,000 per kilowatt in 1973. Plotted on the abscissa is not only time but power, and what is evident is the fact that it has been the development of high powered accelerators that has brought about this very dramatic shift in cost.

	Van de Graaff (1950)	Dynamitron™ (1973)
	3 MeV 1 Ma	3 MeV 50 Ma
	3 kW = 2400 Mrad-lb/hr	150 kW = 120,000 Mrad-lb/hr
Capital Cost		
Accelerator	\$ 75,000 (\$25,000/kW)	\$450,000 (≈ \$3,000/kW)
Shield facility	50,000	100,000
	\$125,000	\$550,000
	OPERATIONAL COSTS (6000 hr/year)	
Amortization:		
10 Year St. Lin.	\$ 12,500	\$ 55,000
Oper. \$4/hr.	24,000	24,000
Overhead	24,000	24,000
(100% Operation)		
Power & Water	600	45,000
Maintenance	6,000	12,000
Misc. \$1/hr.	6,000	6,000
	\$73,000	\$166,000
	\$12.18/hr	\$27.67/hr
	\$ 4.06/kW-hr	\$0.184/kW-hr
	0.51¢ / mrad. lb	0.015¢ / mrad. lb

Figure 2 — Effect of Power Output on Radiation Costs

Not only has the capital cost shifted most favorably, but this is reflected even more so in the cost to irradiate products. This cost can be expressed either in cost-per-kilowatt-hour, or in cost-per-megarad-pound. In Figure 2, I have compared the kind of accelerator that was available in the 1950's with present-day high powered accelerators. As you can see, there is a very dramatic reduction in both cost-per-kilowatt-hour and the cost-per-megarad-pound. Equally important is the fact that if a production need required power of the order of 50 to 150 kilowatts, then in 1950 one would have been facing the possibility of anywhere from 15 to 50 accelerators to accomplish what is being accomplished today with but one.

As a result of this very significant shift in radiation cost downward, a number of very important and growing industrial applications have come on the horizon. The next figure indicates a number of such practical radiation applications which are either in full scale production or rapidly approaching the production stage in the United States today. For example, the first one, the irradiation of polymeric insulation on wire and cable has now reached the point where it is the preferred technique over the more conventional peroxide and heat cure which is categorized as a "CV" treatment. In fact, this

Single user license provided by AAMI. Further copying, networking, and distribution prohibited.

application and most other applications have pointed out the fact that radiation today is no longer a unique and expensive and exotic source of energy. In point of fact, in most cases, it is less expensive than heat and can compete very effectively with heat both on a dollar-and-cents basis, as well as on an energy conservation basis. Figure 4 for example indicates the relative energy input for heat versus radiation for five accepted industrial radiation process techniques. In each instance, as you can see, radiation wins by substantial factors.

Figure 3 — Radiation applications

-
- Upgrading of Polymeric Insulation on Wire and Cable.
 - Crosslinking of Polyethylene Foam for Better Foam Control.
 - Crosslinking of Polyethylene for Improved Stress-Work Resistance.
 - Vulcanization of Sheet Rubber.
 - Curing of Organic Coating on Plastic, Metal, and Wood Substrates.
 - Curing of Glass Reinforced Polyester Sheets.
 - In Situ Polymerization of Plastic in Wood and Concrete.
 - Curing of Adhesives.
 - Irradiation of Wood Pulp Chips to Increase Pulping Yield.
 - Improving Switching Speeds of Semi-Conductor Diodes.
 - Sterilization of Medical Disposables.
 - Ion Implantation in Semi-Conductor Materials.
-

Figure 4 — Energy Requirement Comparison

	Heat	Radiation
1. Crosslinking Polyethylene on 600V — 4/0 Wire.....	.55¢ / lb.	.28¢ / lb. (15 Mr)
2. Vulcanization of Sheet Rubber.....	1.2 ¢ / lb.	.1 ¢ / lb. (10 Mr)
3. Curing Paint (Energy input for same product thru-put).....	\$4500/month (Gas)	\$900/month (Electricity)
4. Food Preservation.....	0.4 ¢ / lb. per day (Refrigeration)	.01 ¢ / lb. (one time) (.5 Mr)
5. Medical Disposable Sterilization.....	2 ¢ / lb. * (Steam)	.05¢ / lb. (2.5 Mr)

*Based on 26 ¢ / cu.ft. — density 0.2

One might ask the question, “Why is heat more expensive than radiation?” I believe the answer is rather obvious, if one thinks about it. In almost every industrial process application, heat is used very inefficiently with most of the calories either going up the stack or out the walls of the oven, and very little, from the percentage standpoint, going into the product — where obviously it should go. By contrast, in the radiation situation, certainly with electrons, one has a very well defined volume into which all your energy is deposited. Consequently, if one can put the product in or conform the product to this energy volume, then the transfer of energy to product becomes quite efficient. Point in fact, this is exactly what is done in many industrial process applications involving electrons.

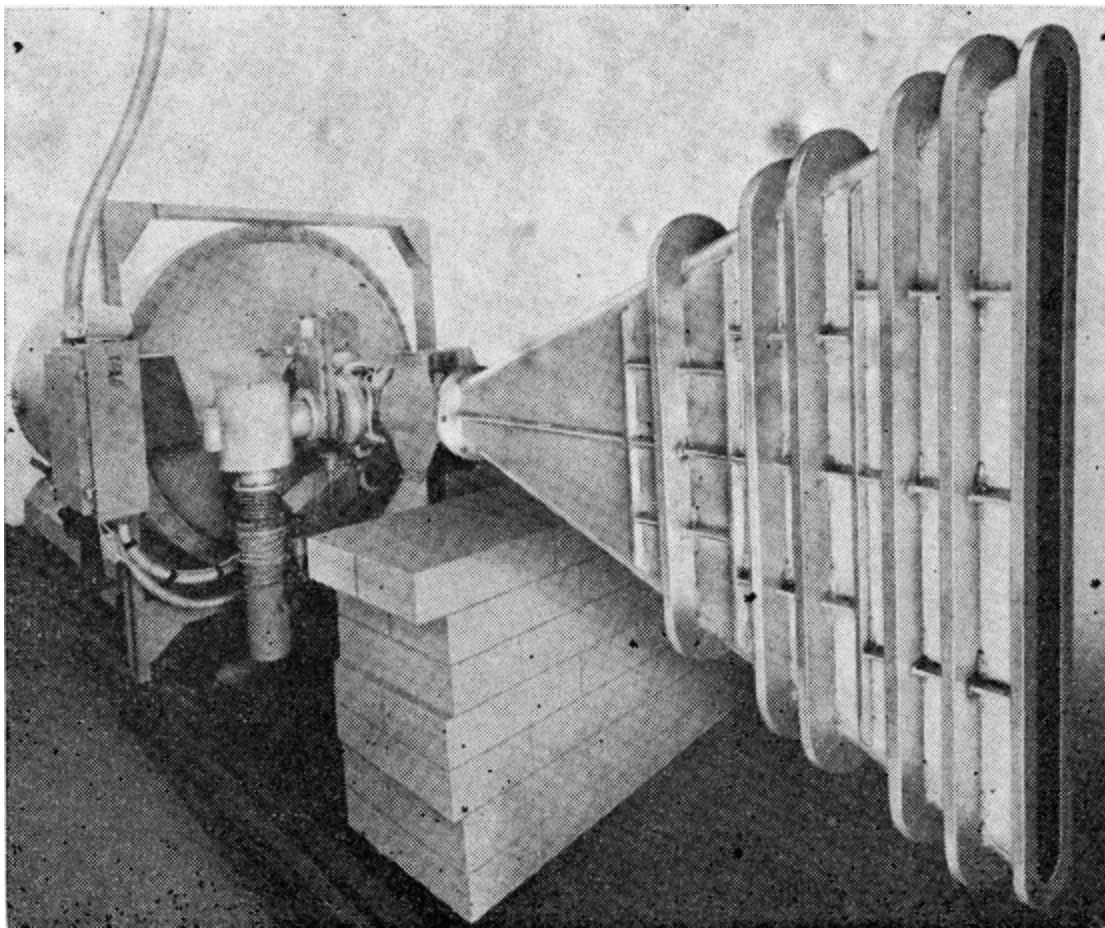

Figure 5.

To return to the basic topic of medical sterilization, it is my feeling that whenever one can, electrons should be used. In many instances, this means rethinking of total production process and perhaps irradiating the product with electrons at a different point in its customary production flow cycle, viz, before it has been packaged into its final shipping container.

In Westbury, we have three accelerators in our Radiation Service Facility. One of these is a 3 MeV unit, which is shown in Figure 5. This unit is used right now with electrons to sterilize medical disposable packages. Recently we have been investigating dosimetry on this machine with heavy Z targets to see what kind of X-ray yields one might obtain. It appears from our dosimetry work that very substantial X-ray outputs are available when this machine is running at 25 mA. In fact, it would appear that the X-ray production efficiency is such that the product throughput capability would be equivalent to that from approximately a 1 million curie cobalt source, and since we are dealing with a 3 MeV X-ray spectrum, the photon penetration is very similar to that from Cobalt-60 gamma rays. From a cost standpoint, this X-ray generator would be considerably less expensive than the equivalent 10^6 curies of cobalt, the facility will be less elaborate, and the product conveyance simpler. Equally important to the radiation is the high degree of reliability exhibited by these new generation accelerators. On stream capability of better than 98% is customary. When one recognizes that with directional "X-rays" the conveyor system is less complicated, then the overall reliability of an X-ray facility is probably comparable to that of a cobalt unit.

To definitively prove the point, at the end of this year we plan to establish a new radiation service facility which will incorporate a 3 MeV, 25 mA Dynamitron™ equipped for both electron and X-ray for product sterilization work.

Thank you for your attention.

Comment by Anonymous Speaker

I can just make a comment. It's in reference to my opinion on this point. I am a schizophrenic. That many of us know. However, there is no question in my mind that whenever the throughput is large enough, when you can use an accelerator, they are a joy. However, I would not want to put the cobalt application down because if you want a small operation, they are very effective and you can operate cobalt facilities almost without any people, once you have put it up. Therefore, throughput makes a difference; when there is a low throughput and also when you need, because of bulk, high penetration, you must use cobalt. On the other hand, when you go to high throughput, when you can afford to have a man there almost all the time, as you need when you have an accelerator facility, then when the throughput is so large that you can afford to pay the salary of one man, then the accelerators are the choice, if the penetration is adequate. That is my comment.

Comment by:

Z. P. ZAGÓRSKI — Poland

Concerning the future of ionizing radiation, I would like to say a few words of advice to the representatives from countries who do not irradiate as yet on a commercial scale. Based on experience in the building of the latest irradiation facilities, there are different approaches to take as the first step. One approach is to buy the whole piece of equipment because there may be a variety of items to be sterilized. We were unable to do this in Poland because of shortages in hard currency, different legal questions, embargoes, etc. The decision to buy the machine from abroad solved only half of the problem. The supplier from the USSR was not able to deliver the conveyor. Now we know that the conveyor is an integral part of any irradiation installation, either isotopic or electrical of equivalent activity exceeding many kilocuries of cobalt-60 and construction of the facility without an efficient transportation system makes no sense. We have constructed an original conveyor and reached different ranges in processing which can be developed on semi-industrial scales, not on irradiation sterilization. Now I will stress the importance of a conveyor and I cannot agree that all has been done in this respect. For instance I don't think a stainless steel mesh conveyor is an optimal construction. I would construct something which would enable us to make a bit more sophisticated electronics, thereby ensuring the administration of proper dose, fire safety etc.

Comment by:

N. HOLM — Denmark

Thank you Mr. Chairman, I told you the first day that I was my boss for 7 years, so I would like to maintain that I'm at least a bit schizophrenic, but I would like to say to Mr. Jefferson that I have no personal experience with the equipment operated at Wantage, so of course, I cannot comment on it. But I can give the same comment as I gave at the U.S. Conference in Washington in October 1972, reporting on 10,000 hours of operation with the latest accelerators and that their reliability factor was better than 95%. I believe this compares favorably with what most cobalt plants achieve. I should perhaps add in this context that there are no technical university graduates on the staff of Risø. So

perhaps, it depends on the kind of machine you buy. My second comment is to Mr. Frohnsdorff. Like Dr. Morganstern, I think I could challenge you on a number of points. But I'm getting old and I'm getting less aggressive. But I would like to make one remark, that the remarks you made on electron accelerators were almost on every point in contradiction with my personal knowledge and experience. So I would like you, if you would be kind enough, to give your sources of information in terms of literature references, because it seems this information has escaped my attention.

Comment by:

R. FROHNSDORFF — England.

Well it's not much. I think I have made very few comments on electron machines. I know very little about them. I'm not an electrical engineer. My comments I thought were directed to electrons and the ability of electrons to penetrate. The actual graph that I reproduced came from the High Voltage catalogue. The illustration is my own to try to illustrate what to me seems the problem with the sweep electrons and the passage over the product, particularly when you get to the extremely high energies where you get almost 2.5 megarads on each pulse, you have a very difficult problem. How does one not get overlap of the voltage? How do you explain this to me?

Comment by:

N. HOLM — Denmark

I should perhaps ask Dr. Paris if that was a '48 or '51 catalogue. But regarding overlap of beam parts on the linac at Risö accelerators — before the product has moved a distance on the conveyor corresponding to the size of one spot, the scan has swept over that place 24 times. Regarding your comments on your unawareness of any dosimeter systems which could take this particular problem into account, I think I should just say that if you have irradiated thousands of pieces and never seen that kind of a thing, chances are good that the effect does not occur. But I did not really like to get into detailed information, but I would like to have your literature entered in the records.

Comments by Anonymous Speaker

I'd like to just reconfirm some of the things Neils Holm just said. I think, Mr. Jefferson, you are still suffering from the Ethicon syndrome. They started with accelerators many years ago. I think the point, the main point I'm trying to make, frankly is that there has been a lot of change during the last 10 years and let me cite you one specific example. We have a machine and I can give you the reference on it, if you want; an industrial machine, that has been performing for 9100 hours. It went on stream last March, it's been down for 1½ hours from an electrical storm. The machine itself has not been touched. I don't really know what the on-stream or reliability is of cobalt-60 plants, but I think this "fiddly" mechanism thing that you were talking about can be very substantial. I know some of the plants I visited, they tell me they replaced the organic hoses on their hydraulic systems like every three months. So if there is a cobalt facility that anyone is aware of that's gone on for 9000 hours without any downtime, I sure would like to know about it.

Comments by Anonymous Speaker Copying, networking, and distribution prohibited.

We have been operating our 3 megacurie source, year round. We have also a very large accelerator and we are irradiating many tons, hundreds of tons of products per year and our experience with the linac accelerator is that the main problem is with the conveyor. This again is a mechanical problem, as vacuum problems don't exist with the accelerators any more. This is something that is past. But I would say today there are no problems. You know there has been tremendous improvement in electronics in the last 10 years. We had good electronics in the 50's, we had good electronics in the early 60's, but today, we have fewer mistakes. You will now find a radio or a television that has few mistakes today, and for a very good reason. This is the same with accelerators and so it is correct when accelerator people say that technology is far better today in that respect and, with our experience, that approximately 80% of our trouble, which is approximately 5% of the operation time, has been with a conveyor. We have also tried to improve the conveyor reliance. We have taught our maintenance people to check the conveyor. The accelerator itself is not the problem. It is the conveyor, if anything. When we compare the cost of a cobalt-60 facility and an accelerator facility in this respect, the conveyor is many times more complicated than in an accelerator facility. But again I would like to see a man operating the accelerator all the time. If our accelerator deviates from what it should be, we have of course an alarm. That will call an operator to correct the deviation. Let me just repeat again that in our experience and I think that this is a very large experience, that the trouble has been with the conveyor. Of course, you need a control in a cobalt facility and you need a control in an accelerator facility. So again, we can say that irradiation costs today are so small compared with the rest, that what we're looking for is an improvement in quality, an improvement in reliability. Therefore, I would come back again, if accelerators can be used, use them. If they cannot be used, then use the cobalt.

Comment by:

W. RAMLER — USA

I would like to just add a few comments. I think everything has been pretty fairly covered, but I think I have a sort of unusual position. I have spent many years in the National Laboratory in the States setting up a low energy accelerator facility and since it's been recent that I have come over to the business side, I can see both sides of the picture. But let me assure you that from the accelerator standpoint, that if the equipment is properly designed, and you have proper safety factors put in from the electrical engineering side; mechanical side and the vacuum side, you can come up with operations efficiency in a year that is in the 96 or 98% class.

Comment by:

H. B. RAINEY — New Zealand

I represent a country which, in my mathematics, is about 0.1% of the world population and perhaps our efficiency should be treated in that vein. I have had experience and have been involved with a firm operating a cobalt-60 facility and just to answer Ken Morganstern's comments, we have experience, which suggests or indicates an 1800hr period, without any downtime. Our average downtime over the 8 year period is something of the order, and I'm taking this off the top of my head, is something like 0.8% unplanned downtime of our facility. I would like to make a further point and that is for a country of three million people, the sterilization is done by one man and, if you can visualize it, half a

woman. This combination of human beings is doing the sterilization officially for all the hospital supplies for all of the New Zealand hospitals. I think that is another consideration of a cobalt plant which has not been taken into consideration, namely, the low manpower required to run the plant.

Comment by:

S. JEFFERSON — England

I would like to remark that the design of cobalt-60 plants has not stood still either. The plant that most of you or many of you are familiar with, used a conveyor which is largely discontinuous in its operations, and the irradiation area contains components which are radiation sensitive. The ones that we had, that required replacement from time to time, just are not present in the up-to-date designs. The most modern design uses a completely continuous system with no sensitive materials whatever in the irradiation cell and the sort of servicibility that is very commonly achieved is certainly nearer to 99% than any other figure.

Participants

Adams, G. E.

C.R.C. Gray Laboratory,
Mount Vernon Hospital,
Northwood, Middlesex,
England HA6 2RN

Altmann, H.

Institute of Biology,
Seibersdorf Research Centre,
A-2444, Seibersdorf,
Austria

Antoni, F.

Director,
Institute of Medical Chemistry,
Semmelweis University of Medicine,
Puskin u. 9
1088 Budapest VIII,
Hungary

Barnes, W.

Johnson & Johnson, Ltd.,
260 Bath Road,
Slough, Bucks, SL1 4EA
England

Baumeister, H.

Ethicon, G.m.b.H.
Robert Koch Strasse 1,
2-Hamburg-Norderstedt-2
Federal Republic of Germany

Bernecker, P.

Johnson & Johnson G.m.b.H.
Tandelmartgasse #15
A-1020, Vienna,
Austria

Berry, R. J.

Research Institute,
The Churchill Hospital,
Headington, Oxford, OX3 7LJ
England

Bishop, A.

Scientific and Technical Branch,
Ministry of Health and Social Security,
14 Russell Square,
London, WC1 B 5EP
England

Bonds, B. L.

Director of Quality Control,
Travenol Laboratories, Inc.,
Deerfield, Illinois 60015
U.S.A.

Bradbury, W. C.

Johnson & Johnson
501 George Street,
New Brunswick, New Jersey 08903
U.S.A.

Brickman, L.

Johnson & Johnson
501 George Street,
New Brunswick, New Jersey 08903
U.S.A.

Brush, G. M., Jr.

Johnson & Johnson
501 George Street,
New Brunswick, New Jersey 08903
U.S.A.

Brynjolfsson, A.

Acting Associate Director for Food Radiation,
Department of the Army,
U.S. Army Natick Laboratories,
Natick, Massachusetts 01760
U.S.A.

Candela's, C.

Comitato Nazionale per l'Energie Nucleare
Division di Protezione Sanitaria e Controlli
Viale Regina Margherita, 125
00198 Roma
Italy

Chadwick, K. H.

Association EURATOM-ITAL
P.O. Box 48, Wageningen
The Netherlands

Chapiro, A. E.

Directeur de Recherches,
Laboratoires de Bellevue,
Centre National de la Recherche, Scientifique,
1 Place A Briand,
92 Bellevue,
France

Charlesby, A.

Head, Department of Physics,
The Royal Military College of Science,
Shrivenham,
Swindon, Wilts, SN6 8LA
England

Christensen, E.

Statens SerumInstitut,
Amager Boulevard 80,
DK2300 Copenhagen,
Denmark

Chu, R.

Atomic Energy of Canada, Ltd.,
P.O. Box 6300,
Station J
Ottawa, K2A 3W3
Canada

Corwin, M. P.

Manager, Sterilization Engineering,
Becton, Dickinson and Company,
Rutherford, New Jersey 07070
U.S.A.

Cox, M. C. L.

Medical Director for Europe,
Becton, Dickinson and Company,
37 av Marie Reynoard
Grenoble,
France

Crawford, C. G.

Storgatan 49
S-44060 Skärhamn
Sweden

Crowley-Millings, M. C.

CERN
CH-1211 Geneva 23
Switzerland

Czermak, E.

Oberphysik, Rat
Gesundheitsamt der Stadt Wien
MA 15
Gonzagagasse 23
1013 Vienna,
Austria

Dawson, O.

Ethicon, Ltd.,
P.O. Box 408,
Bankhead Avenue,
Edinburgh EH11 4HE
Scotland

Dean, W. R.

Johnson & Johnson Ltd.,
Southampton Road,
Cosham
Portsmouth, Hants, PO6 4RL
England

Diding, N.

Director,
World Health Organization,
Centre for Chemical Reference Substances,
Apotekens Centrallaboratorium,
Box 3045,
S-173 03 Solna,
Sweden

Draganić, I. G.

Head, Radiation Chemistry Laboratory,
“Boris Kidrič” Institute-Vinča
P.O. Box 522,
Beograd,
Yugoslavia

temporary address:

Office of Atomic Energy for Peace,
Srirubsook Road, Bangkok
Bangkok-9, Thailand

Draganič, Z. D.

“Boris Kidrič” Institute-Vinč
P.O. Box 522,
Beograd, Yugoslavia

DuFresne, A.

Multiscience Publications,
1253 McGill College,
Suite 404,
Montreal, Quebec H3B 2Z1
Canada

Dvornik, I.

Institute “Ruder Bošković”
Bijenicka cesta
41001 Zagreb, Croatia
Yugoslavia

Edwards, R.

Managing Director,
H. S. Marsh Nuclear Energy Ltd.,
Southampton Street,
Reading, Berks,
England

Eisenlohr, H.

Head, Dosimetry Section,
Division of Life Sciences,
International Atomic Energy Agency,
Kärntner Ring 11, P.O. Box 590,
A-1011 Vienna,
Austria

Ellis, S. C.

Division of Radiation Science,
National Physical Laboratory,
Teddington, Middlesex
TW11 0LW
England

Eyal, J.

Sor-Van Radiation Ltd.,
P.O. Box 214,
Yavne,
Israel

Eymery, R.

S. A. R.
Centre d’Etudes Nucléaires de Grenoble,
BP 85 Centre de Tri,
38041 Grenoble Cédex,

France

Physikalisch-Technische Bundesanstalt
33 Braunschweig
Bundesallee 100
Federal Republic of Germany

Institute of Isotopes
Hungarian Academy of Sciences
H-1525 Budapest 114, P.O. Bor 77
Hungary

High Voltage, Ltd.,
8 Kildare Close
Managing Director,
Eastcote
Ruislip, Middlesex, HA4 9LH
England

Chef de la Section de Dosimétrie Physique
Commissariat à l'Énergie Atomique
B.P. #6
92260 Fontenac-aux-Roses
France

Gillette Industries, Ltd.
Research & Development Laboratory — U.K.
450 Basingstoke Road
Reading, Berkshire, RG2 0QE
England

Johnson & Johnson
501 George Street
New Brunswick, New Jersey 08903
U.S.A.

Head, Control and Media Department
National Institute of Public Health
Postuttak
Oslo 1
Norway

Head, Laboratory of Radioisotopes
Institute of Atomic Physics

Feist, H.

Földiák, G.

Fox, T. B.

François, H.

Frohnsdorff, R. S. M.

Fuller, R. A.

Fystro, D.

Galateanu, I.

P.O. Box 35
Bucharest
Romania

Gaughran, E. R. L.

Johnson & Johnson
501 George Street
New Brunswick, New Jersey 08903
U.S.A.

Germinet, M.

Laboratoire Roger Bellon
150 av. du Roule
92-Neuilly sur Seine
France

Getoff, N.

Lehrkanzel für Strahlenchemie
Institut für Radiumforschung und Kernphysik
Österr. Adademie der Wissenschaften
1090 Wien Warkringerstr 38
Austria

Goudie, A. J.

Johnson & Johnson
501 George Street
New Brunswick, New Jersey 08903
U.S.A.

Grant, J.

Director
Irradiated Products, Ltd.
Elgin Industrial Estate
Elgin Drive
Swindon, Wilts
England

Grenshaw, C. G.

Everett Medical Product Ltd.
2-10 Commonsides East
Mitcham
Surrey CR4 1YN
England

Greshner, O.

Johnson & Johnson
Caixa Postal, 136
São Paulo
Brazil

Haimson, J.

President
Haimson Research Corporation
Northwest Industrial Park
South Avenue
Burlington, Massachusetts 01803
U.S.A.

Harbord, P. E.

Johnson & Johnson
Southampton Road
Cosham
Portsmouth, Hants, P06 4RL
England

Herrnhut, H.

Sulzer Brothers Ltd.
8041 Winterthur
Switzerland

Hildick-Smith, G.

Johnson & Johnson
501 George Street
New Brunswick, New Jersey 08903
U.S.A.

Holm, N. W.

Assistant Director
Atomic Energy Commission
Research Establishment Risø
DK-4000 Roskilde
Denmark

Horváth, S.

Institute of Isotopes
Hungarian Academy of Sciences
H-1525 Budapest 114, P.O. B. 77
Hungary

Hudson, C.

Johnson & Johnson (Pty.) Ltd.
P.O. Box 727
East London 5200
South Africa

Hunt, S. E.

Head, Department of Physics
University of Aston
Gosta Green
Birmingham B4 7ET
England

Icre, P.	Centre d'Application des Rayonnements Ionisants de Corbeville B.P. n° 35 91402 Orsay France
Ingvorsen, H.	Director, cand. pharm. NUNC (A/A) 8 Algade, P.O. Box 280 DK-4000 Roskilde Denmark
Irani, S. A.	Johnson & Johnson International 501 George Street New Brunswick, New Jersey 08903 U.S.A.
Ivanov, A. S.	Committee for the Utilization of Atomic Energy Staromonetnyy Peteulok, 26 Moscow, ZH-180 U.S.S.R.
Iwatschenko,	Messrs. Pfrimmer & Co. 8520 Erlangen Hofmannstrasse 27 Federal Republic of Germany
Jefferson, S.	U.K. Panel on Gamma & Electron Irradiation 19 Benyon Court, Bath Road Reading, Berkshire England
Jennings, W. A.	Head, Dosimetry Section Division of Radiation Science National Physical Laboratory Teddington, Middlesex TW11 0LW England
Jensen, V. G.	Danmarks Farmaceutiske Hopkole Universitetsparken 2 DK-2100, Copenhagen Denmark

Johnson, F. N.

U.S. Pharmacopeia
12601 Twinbrook Parkway
Rockville, Maryland 20852
U.S.A.

Juul, F.

Vice Director
Atomic Energy Commission
Research Establishment Risø
DK-4000 Roskilde
Denmark

Kelliher, M. G.

Managing Director,
Radiation Dynamics Ltd.
P.O. Box 10
South Marston Swindon, Wilts,
SN3 4TB
England

Kelsey, J. C.

Deputy Director of Public Health Laboratory
Service
Public Health Laboratory Service Board
Lower Entrance, Colindale Hospital
Colindale Avenue
London, NW9 5EQ
England

King, M.

Atomic Energy Research Establishment
Chemistry Division, Bldg. 10.30
Harwell
Didcot, Berks, OX11 0RA
England

Knapp, E.

Stadtphysikus
Gesundheitsamt d. Stadt Wien
MA 15
Gonzagagasse 23
1013 Vienna
Austria

Kramer, H.

Johnson & Johnson
501 George Street
New Brunswick, New Jersey 08903

U.S.A.

Committee for the Utilization of Atomic Energy
Staromonetnyy Peteulok, 26
Moscow, ZH-180
U.S.S.R.

Krushev, V.

Head, Control Laboratory
National Institute of Public Health
Sterrenbos 1
Utrecht
The Netherlands

Lansberg, H. P.

Sekt. 2, Abt. 1/3
Bundesministerium f. Gesundheit und
Umweltschutz
Stubenring 1
A-1010 - Vienna
Austria

Laurencic, O.

Division of Life Sciences
International Atomic Energy Agency
Kärntner Ring 11, P.O. Box 590
A-1011 Vienna
Austria

Lerch, I. A.

Johnson & Johnson AB
191-84 Sollentuna
Sweden

Malmström, B.

Center for Radiation Research
U.S. Department of Commerce
National Bureau of Standards
Washington, D.C. 20234
U.S.A.

McLaughlin, W. L.

Bundesstaatl. Bakteriolog. - serolog.
Untersuchungsanstalt
Weissenwolffstrabe 28
4010 - Linz
Austria

Megay, K.

Johnson & Johnson Pty. Ltd.

Melrose, G. J. H.

Stephen Road
Botany, 2019
Australia

Michael, B. D.

C. R. C. Gray Laboratory
Mount Vernon Hospital
Northwood, Middlesex, HA6 2RN
England

Milos, C.

635 Ridgewood Avenue
Oradell, New Jersey 07649
U.S.A.

Morganstern, K. H.

President
Radiation Dynamics, Inc.
1800 Shames Drive
Westbury, Long Island, New York 11590
U.S.A.

Mukherjee, R.

Division of Life Sciences
International Atomic Energy Agency
Kärntner Ring 11, P.O. Box 590
A-1011 Vienna
Austria

Muxfeldt, H.

Ethicon G.m.b.H.
Robert Koch Strasse 1
2-Hamburg-Norderstedt-2
Federal Republic of Germany

Nablo, S. V.

Vice-President
Energy Sciences, Inc.
111 Terrace Hall Avenue
Burlington, Massachusetts 01803
U.S.A.

Nunan, C. S.

Varian Associates, Inc.
611 Hansen Way
Palo Alto, California 94303
U.S.A.

O'Brien, W. F.

Johnson & Johnson, Ltd.
260 Bath Road

Slough, Bucks, SL1 4EA
England

Olderman, G. M.

Johnson & Johnson
501 George Street
New Brunswick, New Jersey 08903
U.S.A.

Olejnik, T.

Johnson & Johnson
501 George Street
New Brunswick, New Jersey 08903
U.S.A.

Olivar, E.

Leiter Der Abt. Biologische Qualitäts Kontrolle
c/o Shering A.G.
P.O. Box 650 311
1000 Berlin 65
Federal Republic of Germany

Österberg, B.

Johnson & Johnson AB
191 84 Sollentuna
Sweden

Ostrowski, K.

Department of Histology & Embryology
Institute of Biostructure
Medical School
02-004 Warsaw, Chalubińskiego 5
Poland

Ouwerkerk, T.

Gammaster
Europalaan 2
Postbox 2066
Utrecht
The Netherlands

Paris, C. H.

Managing Director
High Voltage Engineering Europa B.V.
Amsterdamseweg 61
P.O. Box 99
Amersfoort
The Netherlands

Parisot, H.

Bundesministerium f. Gesundheit und
Umweltschutz
Stubenring 1
1010 - Vienna
Austria

Peter, K. H.

Director
R & D Department
Willy Rüsck
7050 Waiblingen
Postfach 1620
Federal Republic of Germany

Phillips, G. B.

Director, Research Center
Becton, Dickinson and Company
P.O. Box 12016
Research Triangle Park
North Carolina 27709
U.S.A.

Plenio, H. U.

Johnson & Johnson G.m.b.H.
Robert-Koch-Strasse 1
2-Hamburg-Norderstedt-2
Federal Republic of Germany

Plester, D. W.

Plastics Division
Imperial Chemical Industries Ltd.
P.O. Box 6
Bessemer Road
Welwyn Garden City
Hertfordshire AL7 1HD
England

Pröpstl, G.

Leiter-Buro EURISOTOP
Generaldirection Gewerbliche
Wirtschaft und Technologie
Kommission der Europäischen Gemeinschaften
200, rue de la Loi
B-1040, Brussels
Belgium

Qie, S. H.

National Institute of Public Health
Postuttak

Oslo 1
Norway

temporary address:

Statens Bakteriologiska Laboratorium
S-105-21
Stockholm
Sweden

Radiation Chemistry Department
“Boris Kidrič” Institute
P.O. Box 522
11001 Belgrade
Yugoslavia

Radak, B.

Tasman Vaccine Laboratory Ltd.
33 Whakatiki Street
Upper Hutt
New Zealand

Rainey, H. B.

General Manager
Radiation Polymer Company
Van Dyke Road
P.O. Box 322
Plainfield, Illinois 60544
U.S.A.

Ramler, W.

Institute “Ruder Bošković”
Bijenicka cesta
41001 Zagreb, Croatia
Yugoslavia

Razem, D.

Head, Industrial Applications & Chemistry Section
International Atomic Energy Agency
Kärntner Ring 11, P.O. Box 590
A-1011 Vienna
Austria

Richman, D. M.

Statens Bakteriologiska Laboratorium
S-105 21
Stockholm
Sweden

Ringertz, O.

Roushdy, H.

Director, National Centre of Radiation
Technology
Atomic Energy Establishment
Cairo
Egypt

Ruffo, A. P.

Johnson & Johnson, Ltd.
7101 Notre Dame St. E.
Montreal 5, Quebec
Canada

Salimov, R.

Institute of Nuclear Physics
Novosibirsk
U.S.S.R.

Schietecatte, W.

Head, Radiation Application Section
Institut National Des Radioéléments
c/o (SCK/CEN)
Boeretang 200
B-2400 MOL
Belgium

Schulte-Frohlinde, D.

Max-Planck Institut für Kohlenforschung
Abteilung Strahlenchemie
433 Mülheim, a.d. Ruhr
Stiftstrasse 34-36
Federal Republic of Germany

Scott, H. McG.

Pharmaceutical Division
Imperial Chemical Industry Ltd.
Hurdsfield Industrial Estate
Macclesfield, Cheshire, SK10 2NA
England

Shelley, T. H.

Johnson & Johnson
501 George Street
New Brunswick, New Jersey 08903
U.S.A.

Sizer, I. W.

Dean, The Graduate School
Massachusetts Institute of Technology
Cambridge, Massachusetts 02139
U.S.A.

Skopek, A.

Johnson & Johnson Pty., Ltd.
Stephen Road
Botony, 2019
Australia

Staub, W. A.

Vice-President
C. R. Bard, Inc.
Murray Hill, New Jersey 07974
U.S.A.

Stenger, V.

Institute of Isotopes
Hungarian Academy of Sciences
H-1525 Budapest, 114, P.O. Box 77
Hungary

Stepanov, G. D.

Committee for the Utilization of
Atomic Energy
Staromonetnyy Peteulok, 26
Moscow, ZH-180
U.S.S.R.

Sztanyik, L. B.

Head, Section of Radiation Biology
Division of Life Sciences
International Atomic Energy Agency
Kärntner Ring 11, P.O. Box 590
A-1011 Vienna
Austria

Address after July 1, 1974:

Director
National Research Institute for Radiobiology and
Radiohygiene,
Budapest XXII,
Pentz K.M.5
Hungary

Taylor, C. B. G.

Manager, Isotope Production Unit
The Radiochemical Centre Ltd.
AERE Harwell
Didcot, Berks
England

Vasserman, S.

Novosibirsk
U.S.S.R.

Vidal, P.

Le Président Directeur Général
Société Conservatome
22 Boulevard Georges Clémenceau
92 Courbevoie
France

Vincent, W. W.

Manager, Technical Services
Portex Limited
Hythe, Kent, CT21 6JL
England

Vogt, R.

Johnson & Johnson International
501 George Street
New Brunswick, New Jersey 08903
U.S.A.

Warland, H. M. F.

Manager, Industrial Products Development
Division
Atomic Energy of Canada, Ltd.
P.O. Box 6300
Postal Station J
Ottawa, K2A 3W3
Canada

Warner, H. L.

Johnson & Johnson
501 George Street
New Brunswick, New Jersey 08903
U.S.A.

Weil, R. F.

Director of Research
Passfield Research Laboratories
Van Leer (U.K.) Ltd.
Liphook, Hampshire
England

Zagórski, Z. P.

Deputy Director
Institute of Nuclear Research
03-195 I.B.J. Warszawa-91
ul. Dorodna 16
Poland

